

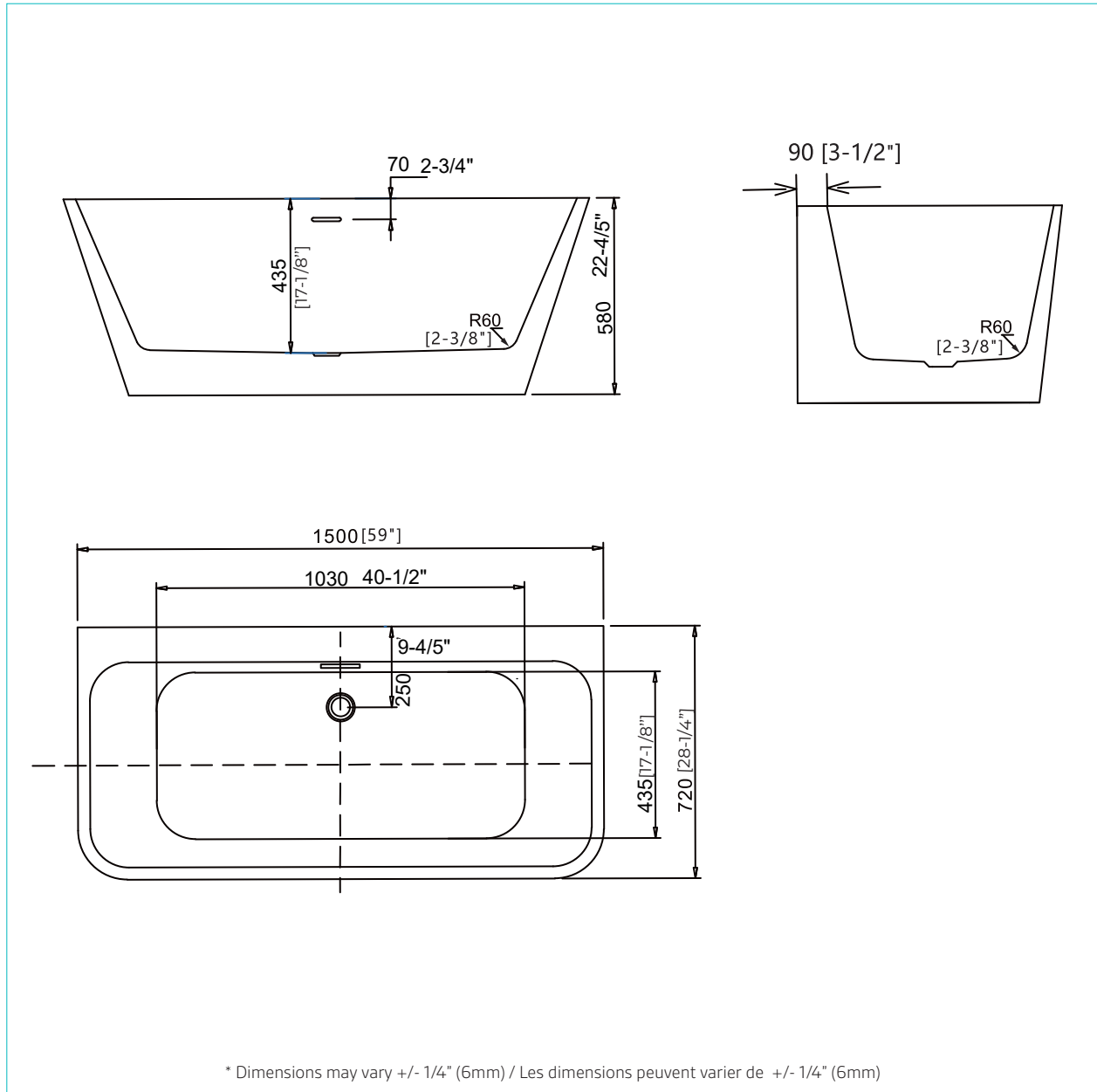

**FREESTANDING  
BATHTUBS**

**BAIGNOIRES  
AUTOPORTANTES**

**BT-206-59**



DIMENSIONS		WEIGHT POIDS	MATERIAL MATERIEL	OVERFLOW HEIGHT HAUTEUR DU TROP-PLEIN	WATER CAPACITY CAPACITÉ DE L'EAU
59 x 28.25 x 22.8 " 1500 x 720 x 580 mm		81.6 lbs 37 Kg	Acrylic Acrylique	14.4" 365mm	50 gal 227 lts
FINISH FINITION	DRAIN LOCATION LOCATION DU DRAIN	PIECES PIÈCES		COMPLIANCE CERTIFICATIONS:	
Glossy Brillant	Off center Décentré	1 pc		Uniform Plumbing Code National Plumbing Code of Canada CSA B45.5-17/IAPMO Z124-2017	



**FREESTANDING  
BATHTUBS**

**BAIGNOIRES  
AUTOPORTANTES**

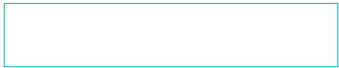

Pure acrylic construction reinforced by fiberglass  
*Construction en acrylique renforcée de fibre de verre*

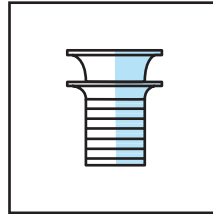

Pop-up drain included  
*Drain pop-up inclus*

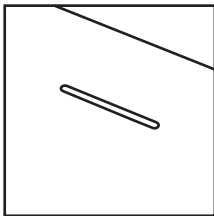

Linear overflow  
*Trop plein linéaire*

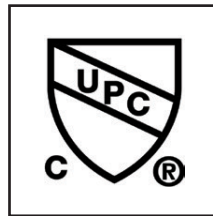

cUPC Certified  
*Certifié cUPC*

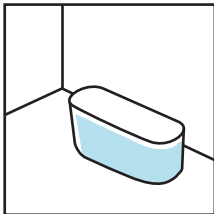

Freestanding installation  
*Installation autoportante*

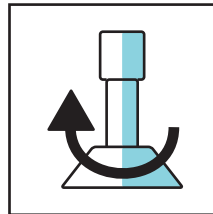

Adjustable feet  
*Pieds ajustables*