



# A&E Bath and Shower

6400A St. Jacques West  
Montreal, QC, Canada  
H4B 1T6  
www.aebath.com

Model Modèle: Alta

Freestanding bathtub *Baignoire autoportante*

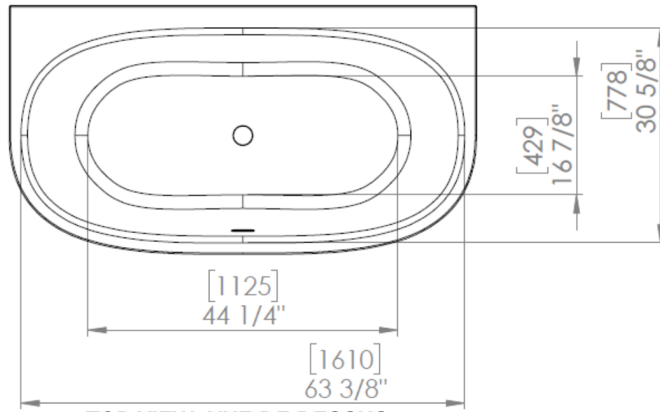

TOP VIEW VUE DE DESSUS

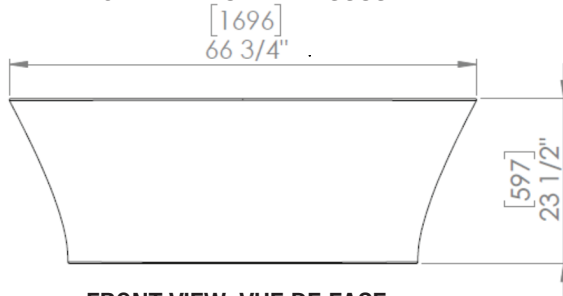

FRONT VIEW VUE DE FACE

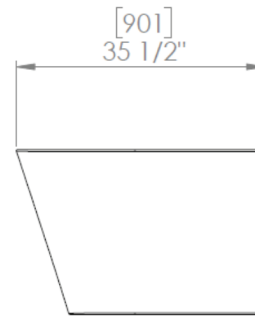

SIDE VIEW VUE DE CÔTÉ



\* Dimensions may vary +/- 1/4" (6mm) / Les dimensions peuvent varier de +/- 1/4" (6mm)

gallons to overflow /	62 gal.
packaging dimension /	69 x 38 x 26 in
approximated weight /	128 lbs
weight with water /	645.7 lbs
bathing well at sump /	44 x 17 in



### Compliance Certifications:

Uniform Plumbing Code  
National Plumbing Code of Canada  
CSA B45.5-17/IAPMO Z124-2017



Pure acrylic construction reinforced by fiberglass  
*Construction en acrylique renforcée de fibre de verre*

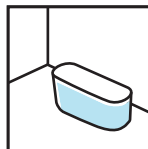

Freestanding installation  
*Installation autoportante*

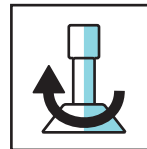

Adjustable feet  
*Pattes ajustables*

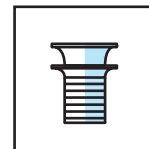

Chrome drain included  
*Drain chrome inclus*

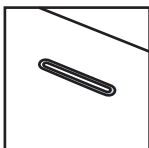

Integrated chrome linear overflow  
*Trop plein linéaire chrome intégré*



CUPC certified  
*Certifié CUPC*