



# A&E Bath and Shower

6400A St. Jacques West  
Montreal, QC, Canada  
H4B 1T6  
www.aebath.com

Model Modèle: Abzu NF

Freestanding bathtub *Baignoire autoportante*

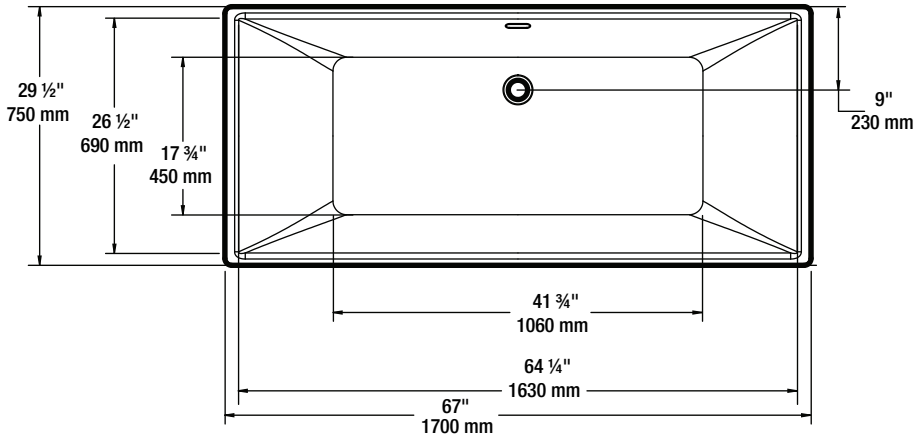

TOP VIEW VUE DE DESSUS

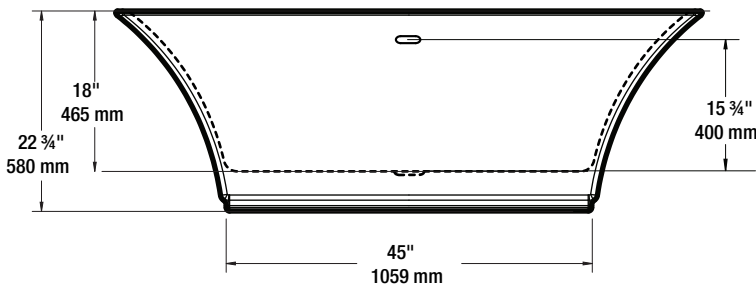
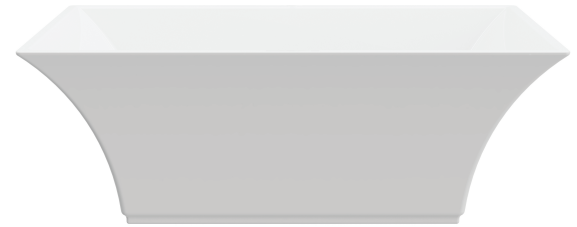

FRONT VIEW VUE DE FACE

\* Dimensions may vary +/- 1/4" (6mm) / Les dimensions peuvent varier de +/- 1/4" (6mm)

gallons to overflow /	55 gal.
packaging dimension /	70 x 33 x 26 in
approximated weight /	130lbs
weight with water /	589.25lbs
bathing well at sump /	42 x18 in



### Compliance Certifications:

Uniform Plumbing Code  
National Plumbing Code of Canada  
CSA B45.5-17/IAPMO Z124-2017



Pure acrylic construction reinforced by fiberglass  
*Construction en acrylique renforcée de fibre de verre*

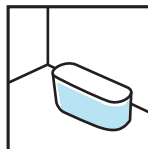

Freestanding installation  
*Installation autoportante*

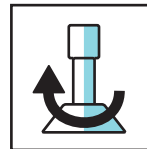

Adjustable feet  
*Pattes ajustables*

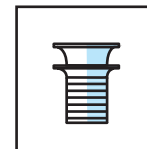

Chrome drain included  
*Drain chrome inclu*

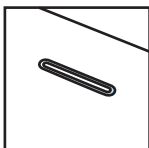

Integrated chrome linear overflow  
*Trop plein linéaire chrome intégré*



CUPC certified  
*Certifié CUPC*