

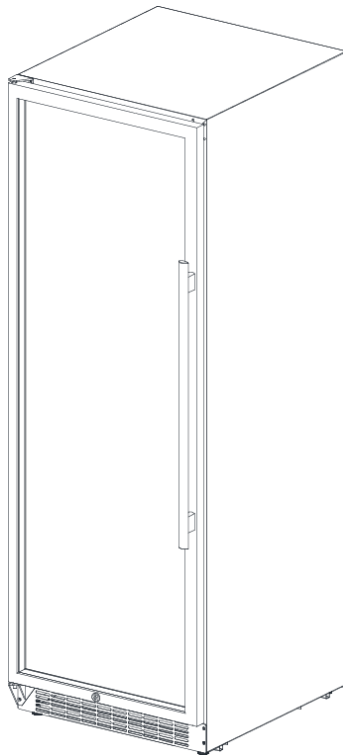

# USER'S GUIDE

Installation, Operation, and Maintenance for your product.



Built-In Wine Refrigerator  
Model – AWC242TSZRH / AWC242TSZLH

[www.avallon.com](http://www.avallon.com)

# Important Safety Information

Improper handling can cause serious damage to the Avallon wine refrigerator and / or injury to the user. This wine refrigerator is designed for domestic indoor use only. Do not use the unit for industrial or commercial use. Any other use may invalidate the warranty. Please review the rating label located on the rear panel of the unit for electrical and other technical data related to this unit. The unit must be used in a properly grounded wall outlet. **Please read and follow the safety information listed below to reduce the risk of fire, electric shock, or injury.**



## ELECTRICAL SAFETY

- Do not exceed the power outlet ratings.
- It is recommended the wine refrigerator be connected on its own circuit.
- The unit must be installed in accordance with state and local electrical codes.
- A standard electrical supply (115 V, 60Hz), that is properly grounded in accordance with the National Electrical Code and local codes and ordinances, is required.
- Use outlets that cannot be turned off by a switch or pull chain.
- Always turn the unit off and unplug it from the outlet when cleaning.
- Unplug the unit if it is not going to be used for an extended period of time.
- Do not operate the unit with a power plug missing the ground plug, a damaged cord, or a loose socket.
- Be sure the wine refrigerator is properly grounded.
- Never plug or unplug the unit with wet hands.
- Do not bypass, cut, or remove the grounding plug.
- Do not use extension cords or power strips with this unit. You may need to contact your electrician if it is necessary to use a longer cord or if you do not have a grounded outlet. Do not modify the power cord's length or share the outlet with other appliances.
- Do not start or stop the unit by switching the circuit's power on and off.
- If the power cord is damaged, it must be replaced by the manufacturer or a qualified technician.
- Never repair the unit while it is plugged in.
- Immediately unplug the unit if it makes strange sounds, emits smells, or smoke comes out of it, and contact customer service.
- Do not remove any part of the casing unless you are instructed to do so by an authorized technician.
- You should never attempt to repair the unit yourself. Contact customer service for service options if the unit needs service.



## GENERAL SAFETY

- To prevent back and other types of injuries, use at least two people to move and install the wine cooler.
- This appliance is not intended for use by persons, including children, with reduced physical, sensory, or mental capabilities, unless they have been given supervision or instruction concerning the use of the appliance by the person(s) responsible for their safety.
- Install the wine refrigerator in a well ventilated area where the ambient temperature is above 50° F and below 90° F.
- The temperature range for this cooler is optimized for wine and beverage storage. Perishable food items may require a different storage environment.
- Do not place hot or warm items into the cooler before they cool down to room temperature.
- This unit is designed to be installed indoors, and protected from rain, sleet, snow, and / or moisture.
- Never allow children to crawl inside the wine refrigerator. If you are disposing of the unit, remove the door.
- Do not use this appliance near flammable gas or combustibles, such as gasoline, benzene, thinner, etc.
- Do not place the unit near heat sources such as ovens, grills, or direct sunlight.
- Only use in an upright position on a flat, level surface and provide proper ventilation.
- Do not pinch or kink the power supply line between the unit and cabinet.
- Do not place any other appliances on top of the unit.
- Do not turn the unit upside down, on its side, or at an angle off level.
- If your model of wine cooler is equipped with a lock, take care to keep the keys away from children.
- Do not move the unit without removing the contents and securing the door in a closed position.



**Note:** Flammable Refrigerant Used! When handling, moving, and using the refrigerator, make sure to avoid either damaging the refrigerant tubing, or increasing the risk of a leak.

# Table of Contents

<i>Important Safety Information</i> .....	<i>ii</i>
<i>Table of Contents</i> .....	<i>iv</i>
First Time Operating Instructions.....	v
<i>Introduction</i> .....	1
<i>Parts Identification</i> .....	2
Full View.....	2
Empty View.....	2
Carbon Filter.....	3
Internal Fan.....	3
<i>Installing Your Wine Refrigerator</i> .....	3
TYPES OF INSTALLATION.....	4
Free-standing Installation.....	4
Built-in Installation.....	4
Installation Clearance Requirements.....	5
LEVELING.....	6
RECOMMENDED GROUNDING METHOD.....	6
<i>Installing Your Door Handle and Shelves</i> .....	7
INSTALLING THE DOOR HANDLE.....	7
INSTALLING THE SHELVES.....	7
REMOVING THE SHELVES.....	8
<i>Operation</i> .....	9
INSTALLATION CHECK-LIST BEFORE OPERATION.....	9
USING YOUR CONTROL PANEL.....	9
<i>Internal Light</i> .....	10
<i>Defrosting</i> .....	11
<i>Normal Sounds</i> .....	11
<i>Cleaning and Maintenance</i> .....	11
INTERIOR CLEANING.....	11
EXTERIOR CLEANING.....	11
<i>Preparing Your Wine Refrigerator for Storage</i> .....	12
<i>Troubleshooting</i> .....	13
<i>Specifications</i> .....	15
<i>Avallon Product Warranty</i> .....	16

**First Time Operating Instructions:**

Before use, make sure all packaging labels and materials are removed from the unit. Be sure to keep track of all included parts and pieces before discarding packaging materials. It is advised that you keep the original box and packaging materials in case you need to move or ship the appliance in the future.

Allow the unit to stand for at least 24 hours before you use it; this allows the cooling components time to settle from transit. The instruction manual should be read before use.

This owner's manual is provided for reference use only. Specifications may change without prior notice. Refer to the product label on the back of your wine refrigerator for the latest technical information.

# Introduction

Thank you for purchasing your Avallon wine refrigerator. Avallon is dedicated to developing products that will enhance your lifestyle with superior quality and distinctive features. Please visit [www.avallon.com](http://www.avallon.com) for more information on your product and other Avallon products.

This manual contains important information regarding the proper installation, use, and maintenance of your wine refrigerator. Following this manual will ensure that your product will work at its peak performance and efficiency.

Please save the original product packaging in case you need to safely transport your wine refrigerator.

## **For Your Records:**

Please write down the model number and serial number below for future reference. Both numbers are located on the rating label on the back of your unit and are needed to obtain warranty service. You may also want to staple your receipt to this manual as it is the proof of your purchase, and is also needed for service under your warranty.

Model Number:

Serial Number:

Date of Purchase:

To better serve you, please do the following before contacting customer service:

- If you received a damaged product, immediately contact the retailer or dealer that sold you the product.
- Read and follow this instruction manual carefully to help you install, use, and maintain your wine refrigerator.
- Read the troubleshooting section of this manual as it will help you diagnose and solve common issues.
- Visit us on the web at <http://www.avallon.com> to download product guides, additional troubleshooting resources, and up-to-date information.
- If you need warranty service, our friendly customer service representatives are available via email at [service@avallon.com](mailto:service@avallon.com).

# Parts Identification

## Full View

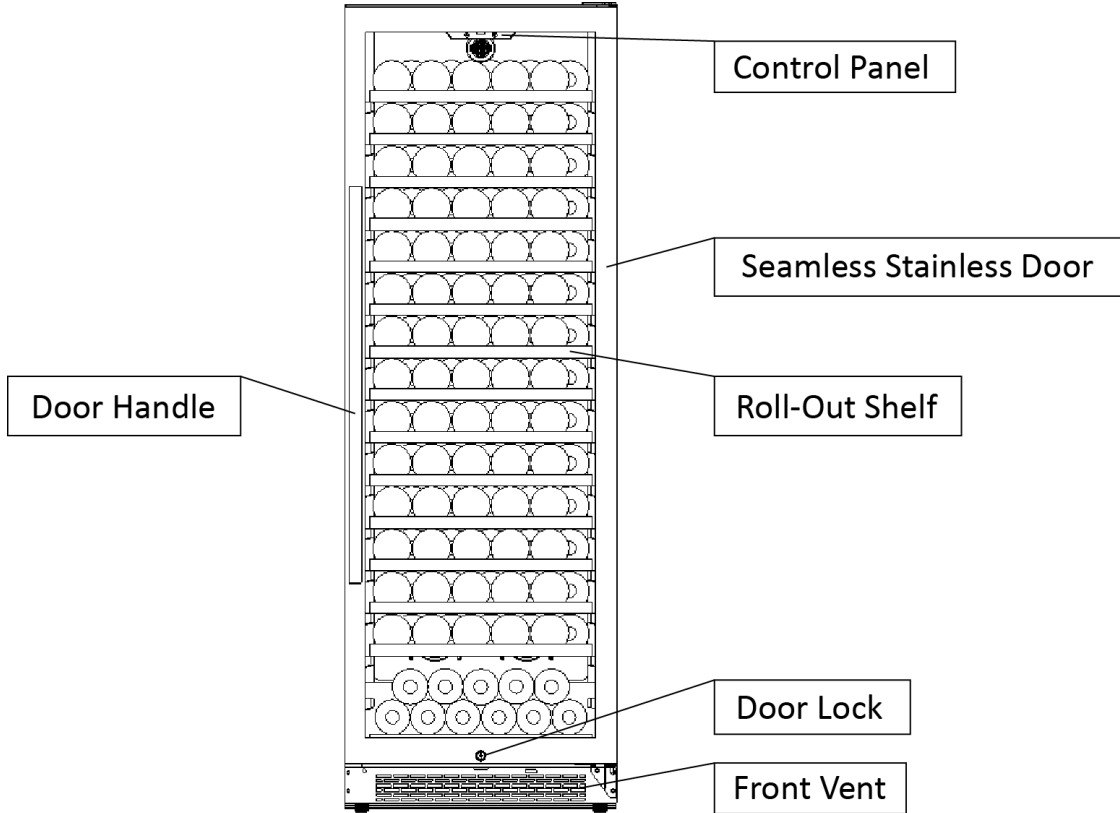

## Empty View

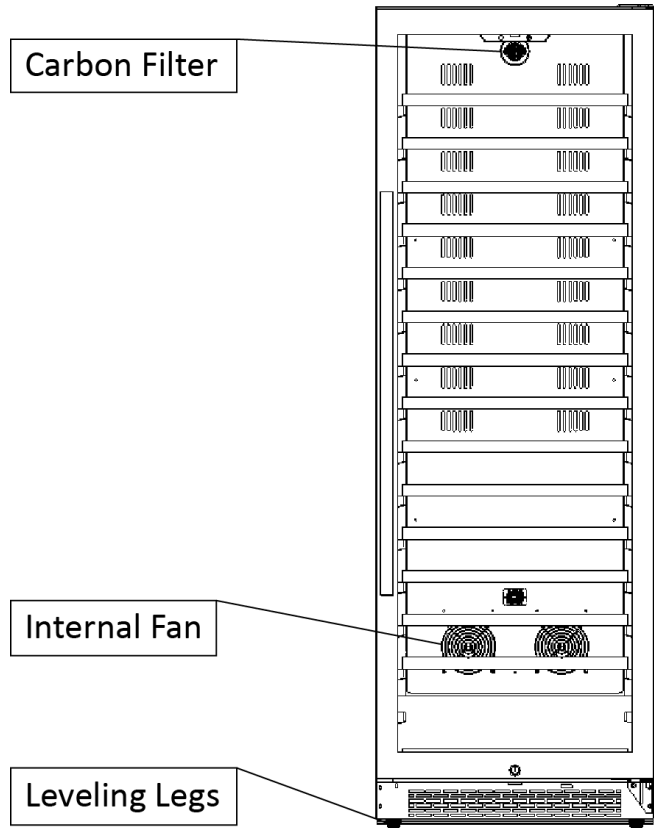

## Carbon Filter

A built-in carbon filter protects your wine by acting as a natural barrier against harmful odors.



## Internal Fan

This is an air-cooled unit equipped with an internal fan that maintains a consistent internal temperature.

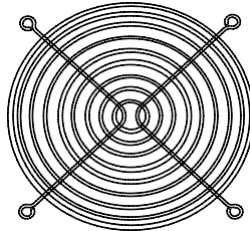

**Note:** The carbon filter should be replaced every 3 - 6 months depending on the unit's exposure level to odor. If the unit is placed in a kitchen, regular replacement every three (3) months is ideal.



**Tip:** Gather the model and serial number from the product label and write them down before installing the wine cooler.

## Installing Your Wine Refrigerator

The wine refrigerator should be installed in accordance with local electrical code requirements. It should also be placed in a location that is strong enough to support its total weight, keeping in mind that it will weigh substantially more when fully loaded than when empty.

Before you plug the wine refrigerator into a power supply, be sure to let it stand upright for at least 24 hours to allow the compressor's oils to settle.



**Warning:** Use two or more people to move and install the wine refrigerator. Failure to do so can result in back or other injury. Carefully remove the packaging materials. Remove any shipping tape and glue from your wine refrigerator before using. Do not use sharp instruments, rubbing alcohol, flammable fluids, or abrasive cleaners to remove tape or glue. These products can damage the surface of your wine refrigerator.



**Important:** Do not remove any safety, warning, or product information labels from your wine refrigerator.



## TYPES OF INSTALLATION:

This wine refrigerator has been designed for free-standing or built-in installation. In every case, there must be adequate ventilation and access for service.

### Free-standing Installation

A free-standing installation will allow you to install the wine refrigerator in almost any place you desire. You must follow the stated instructions for electrical requirements and leveling the wine refrigerator.

### Built-in Installation

A recessed installation will allow you to install the wine cooler under a counter or in a kitchen cabinet provided the clearance space requirements around the wine cooler are followed. It is necessary to allow adequate ventilation space around the unit (make sure there is at least some ventilation room for the back of the unit). The following additional items must be observed:

1. Place the wine refrigerator in front of the installation location.
2. Adjust the feet and place the unit flat on the floor or on a platform depending on your installation requirements.
3. If the electrical outlet for the wine refrigerator is behind the cabinet, plug in the wine refrigerator.
4. Push the wine refrigerator into position.



Warning: DO NOT install the wine refrigerator behind a closed cabinet door.



Warning: DO NOT extend multiple full shelves at the same time. Doing so may put the wine refrigerator at risk of tipping. It is recommended that only one shelf is fully extended at time.

## Installation Clearance Requirements:

When installing the wine refrigerator under a counter, follow the recommended spacing dimensions shown.

- To ensure proper service access and ventilation, allow at least 1-2" of clearance at the back, 1/4" at the top, and 1/4" at the sides. If the door side is against a wall, allow at least 2 3/8" of clearance. The installation should allow the unit to be pulled forward for servicing, if necessary.

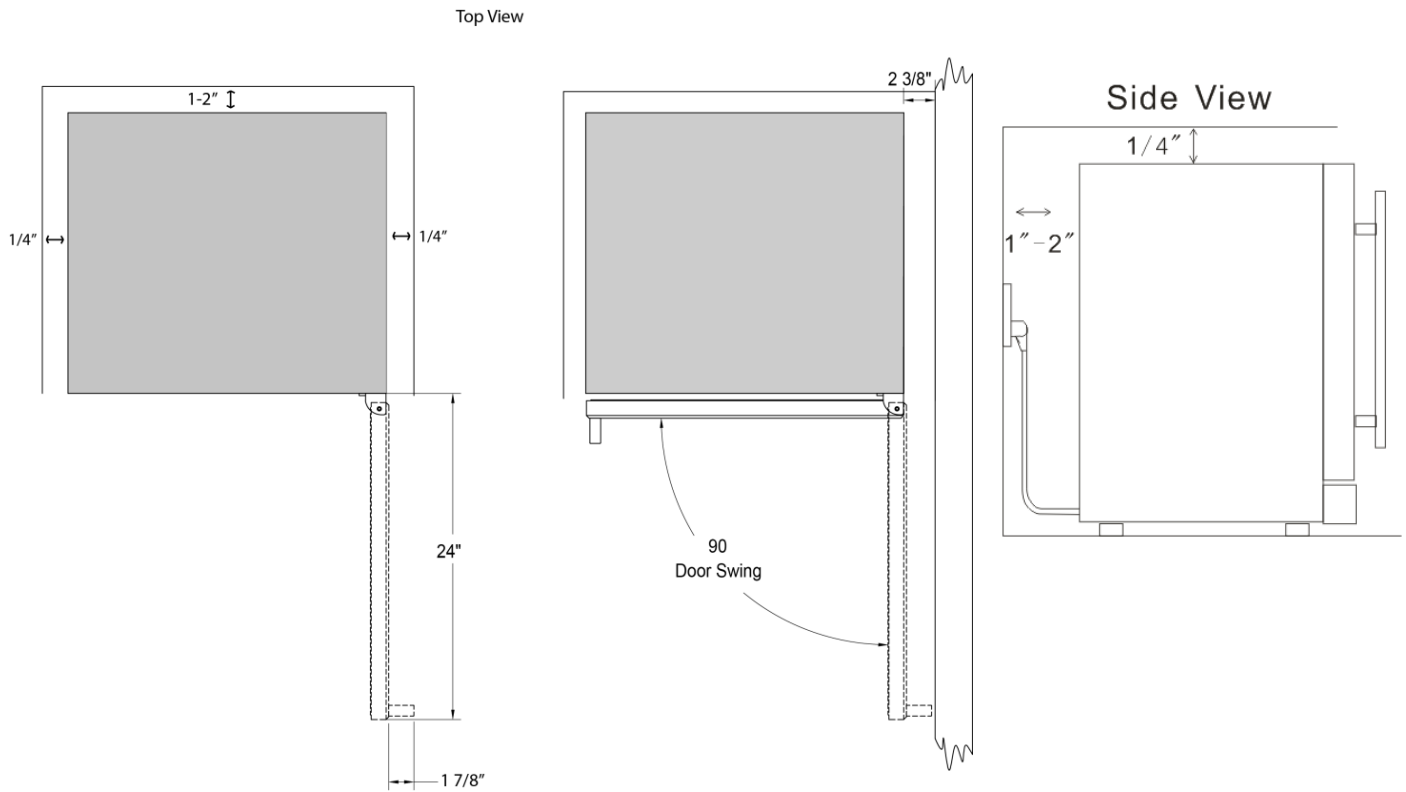

- The installation should allow the unit to be pulled forward for servicing, if necessary.
- A standard electrical supply (115 VAC only, 60 Hz), properly grounded in accordance with National Electrical Code and local codes and ordinances, is required.

## LEVELING:

The wine refrigerator should be installed on a firm and level surface that will be able to support the entire weight of a fully loaded unit. It is important for the wine refrigerator to be leveled in order to work properly. It can be raised or lowered by rotating the plastic sheaths around each of the feet on the bottom of the machine. If you find that the surface is not level, rotate the feet until the wine refrigerator becomes level. You may need to make several adjustments to level it. We recommend using a carpenter's level to check the machine. Turn the leveling feet to the right to lower that side of the refrigerator. Turn the leveling feet to the left to raise that side of the refrigerator.



**Important:** Once you are ready to install the unit in a cabinet or directly on the floor, you must adjust the feet to level the wine refrigerator.

## RECOMMENDED GROUNDING METHOD:

For your personal safety, this appliance must be grounded. It is equipped with a power supply cord having a 3-prong grounding plug. To minimize possible shock hazard, the cord must be plugged into a mating 3-pronged wall socket, and grounded in accordance with the National Electrical Code and local codes and ordinances. If a mating wall socket is not available, it is the personal responsibility of the customer to have a properly grounded, 3-prong wall receptacle installed by a qualified electrician.



### Electrical Shock Hazard!

- Plug into a grounded 3-prong outlet.
- Never remove the grounding prong from the plug.
- Never use an adapter to bypass the grounding prong.
- DO NOT use an extension cord.
- Failure to follow these instructions can result in fire, electrical shock, or personal injury.

Before you move your wine refrigerator into its final location, it is important to make sure you have the proper electrical connection. A standard electrical supply (115 V, 60Hz), properly grounded in accordance with the National Electrical Code and local codes and ordinances, is required. It is recommended that a separate circuit, serving only your wine refrigerator, be provided. Use receptacles that cannot be turned off by a switch or pull chain.

The fuse (or circuit breaker) size should be 15 Amps.

# Installing Your Door Handle and Shelves

## *INSTALLING THE DOOR HANDLE:*

1. Open the door and carefully pull the door gasket around the area where the handle is to be installed.
2. Insert each Phillips head screw through the gasket side of the door until the screw passes through the door.
3. Align the handle with the screws and tighten using a Phillips head screwdriver until the handle is flush against the door frame.
4. Carefully press the door gasket into its original position.



Caution: Do not over-tighten the screws as this may cause damage to the handle or to the stainless steel door.

## *INSTALLING THE SHELVES:*

1. Open the door completely.
2. Line up the shelf notches with the rail posts on both the right and left sides.
3. Push the shelf down and then push it all the way inwards until the shelf fully rests inside of the unit and you are able to close the door.
4. The shelf should glide smoothly back and forth. If it does not, you may need to remove it and start over.



Tip: To prevent damaging the door gasket, make sure to open the door fully before pulling the shelves out of their tracks.

## REMOVING THE SHELVES:

1. Open the door completely.
2. Remove all of the contents loaded on the shelf, if applicable.
3. Line up the shelf notches with the rail posts as indicated below. This will require you to hold on to both rails as you move the shelf to line up the posts with the notches on both sides of the shelf.
4. Evenly lift the shelf up and then pull the shelf out.

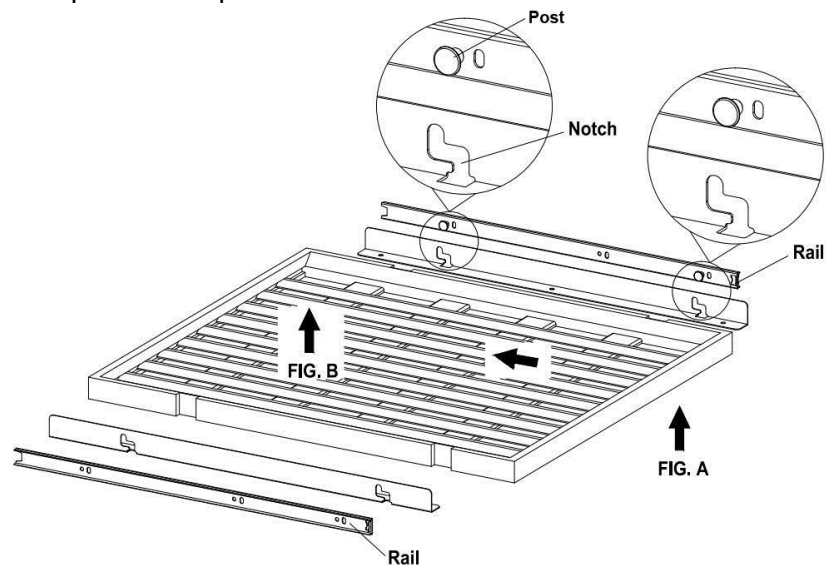

**Note:** This model is manufactured with all rails pre-installed for maximum storage capacity. Our factory default is to include a pre-installed display shelf designed to accommodate most 750 ml wine bottles. Additionally, we include three extra storage shelves for those who opt for more storage capacity. If you choose to utilize the included display shelf, most users will have no functional issues gliding the display shelf back and forth with the factory installed rail above the display shelf still installed. However, some larger Burgundy bottles may contact the overhead post. If this happens, we recommend you remove the interfering rail and re-install just the Philips head screws in the cabinet so there are no holes left agape.



**Tip:** Safely store any removed hardware for possible future use.

# Operation

## INSTALLATION CHECK-LIST BEFORE OPERATION:

1. Have all packing materials and tape been removed from the interior and exterior of the wine refrigerator?
2. Have the installation instructions been followed, including connecting the machine to electricity?
3. Has proper grounding been installed for the wine refrigerator?
4. Has the machine been leveled?
5. Is the wine refrigerator in a site where the ambient temperature is between 50° F and 90° F all year round?
6. Is there a clearance of at least 1- 2" at the rear, 1/4" at the top, and 1/4" at the sides for proper air circulation?

## USING YOUR CONTROL PANEL:



This wine cooler has a temperature range from 40° F to 65° F.



### Power Button

Press and hold this button down for three seconds to power your unit on. Once this button is pressed, the “Run” indicator light will illuminate to indicate the unit is on and running. Press and hold this button for three seconds again and the unit will power off and the “Run” Indicator light will turn off.



### Increasing the Temperature

To increase the temperature, press this button to raise the temperature by one (1) degree increments.



### Decreasing the Temperature

To decrease the temperature, press this button to lower the temperature by one (1) degree increments.



### Interior Light

Press this button to cycle through the different internal light settings. There are four light settings: Constant Blue, Constant White, Automatic Blue, and Automatic White. Press this button to choose the next option in the progression, eventually cycling back to the original setting. The lights will fade out of the previous setting and into the next setting in the cycle each time you press this button. Press and hold this button for three seconds to turn the lights completely off or to turn them back on. Open and close the door to check the internal light color and whether the lights stay on with the door closed (Constant Mode) or illuminate only when the door is open (Automatic Mode). Please refer to the “Internal Light” section on the next page for further detail.



**Note:** Pressing and holding the Increase and Decrease Temperature buttons at the same time will switch the temperature display from °F to °C.



**Tip:** If you powered the unit off, please wait at least five (5) minutes before powering it back on.



**Warning:** Allow at least 24 hours for your wine cooler to run before storing your beverages to allow the temperature to acclimate. Whether your wine cooler can reach the actual set temperature depends on the ambient environmental conditions.

## Internal Light

This refrigerator is equipped with top and side internal lights that can be set to a blue or white color. Because the unit comes with a glass door, the inside will be seen whether the door is open or closed. You can choose to display each color of light in two different modes: Constant Mode and Automatic Mode.

### Constant Mode

The internal lights will stay constantly illuminated whether the door is open or closed.

### Automatic Mode

The internal lights will illuminate each time the door is opened and fade off once the door is closed. This feature is triggered by a sensor located on the front vent. This sensor allows the refrigerator to recognize when the door is open or closed.

With each press of the light button, the unit will progress through the cycle of light settings seen below.

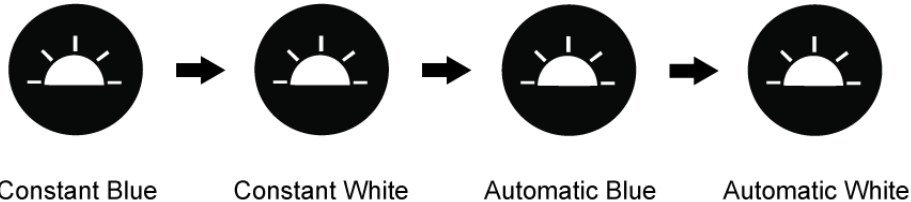

**Note:** We run test every unit that we produce in our factory. Because of this, your model may default to any of the above settings out of the box. Simply cycle through the progression of settings until you reach your desired light setting. The lights will return to the Constant Blue setting after the Automatic White setting, thus starting back at the beginning of the progression.



**Tip:** Close the door to determine if the light is currently in Constant Mode or Automatic Mode. In Constant Mode the lights will remain on, and in Automatic Mode the lights will fade off once the door is closed.

Holding the light button for three seconds will turn the lights completely off or back on. If you power the lights off they will remain off, even when the door is open. Hold the light button for three seconds again to turn the lights back on.

## Defrosting

The wine refrigerator will automatically defrost under most temperature settings and ambient conditions. However, on colder settings, some frost may build up. Additionally, under more humid ambient conditions, more frost may build up. Keep the door closed as much as possible and avoid opening the door unnecessarily to minimize frost build-up.

If frost is preventing the door from closing properly, you may need to power the unit off until the frost melts. Use a soft absorbent towel to dry the unit.



**Warning:** Never attempt to remove frost with a sharp object.

## Normal Sounds

Your new wine refrigerator may make sounds that are not familiar to you. Most of the new sounds are normal. Hard surfaces like the floor or walls can make the sounds seem louder than they actually are. The following describes the kinds of sounds that might be new to you and what may be making them.

- Rattling noises may come from the flow of the refrigerant or the water line.
- Items stored on top of the wine refrigerator can also make noises.
- The high efficiency compressor may make a pulsating or high-pitched sound.
- The internal fan will run frequently to create a consistent internal temperature environment.
- Water running from the evaporator to the water bin may make a splashing sound.
- As each cycle ends, you may hear a gurgling sound due to the refrigerant flowing in your wine refrigerator.
- You may hear air being forced over the condenser by the condenser fan.

## Cleaning and Maintenance

Periodic cleaning and proper maintenance will ensure efficiency, top performance, and long life.

### ***INTERIOR CLEANING:***

1. Disconnect power to the unit.
2. Open the door and remove the contents and shelves.
3. Wait until the unit defrosts.
4. With a clean cloth, wipe down the interior of the unit.
5. Reinsert the shelves and beverages.
6. Reconnect power to the unit.

### ***EXTERIOR CLEANING:***

The door and cabinet may be cleaned with a mild detergent and lukewarm water solution such as two (2) tablespoons of baking soda to one (1) quart of water. Do not use solvent based or abrasive cleaners. Use a soft sponge and rinse with clean water. Wipe the unit with a soft clean towel to prevent water spotting. If the door panel is stainless steel, it can discolor when exposed to chlorine gas and moisture. Clean stainless steel with a cloth dampened with a mild detergent and warm water solution. Never use an abrasive or caustic cleaning agent.



## Preparing Your Wine Refrigerator for Storage

If the wine refrigerator will not be used for a long time, or is to be moved to another place, it will be necessary to defrost the unit and dry the interior.

1. Disconnect the cooler from the power supply by removing the power plug from the wall socket.
2. Leave the door open to allow for air circulation and to prevent mold, mildew, and unpleasant smells.
3. Once the interior is dry and clean the unit will be ready for storage.



**Caution:** Store the unit out of the reach of children. If you have children, you may want to take additional precautions such as removing the door to prevent a child from being trapped inside the cooler.



**Important:** Do NOT touch the power plug when your hands are wet. NEVER unplug the unit by pulling the plug.

# Troubleshooting

ISSUE	POSSIBLE CAUSE	SOLUTION
The wine cooler turns on and off frequently.	The room temperature is higher than the recommended ambient environment.	Run the cooler at the appropriate ambient temperature.
	The door is being opened often.	Minimize the number of times the door is opened.
	The door is not completely closed.	Make sure the door is completely closed.
	The door gasket is not sealing properly.	Make sure the door gasket is properly sealed.
	The cooler does not have the suggested ventilation.	Read and follow the "Installation Clearance Requirements" section.
The wine cooler does not turn on.	There is a power failure.	Ensure the cooler is plugged in and the outlet has power.
	The cooler is not plugged in.	Plug the unit in to a power outlet that has sufficient amperage.
	A house fuse has blown or the circuit breaker is tripped.	Replace the broken fuse in your fuse box or reset the breaker. Make sure the outlet has sufficient amperage. Reduce the number of items sharing the circuit.
The wine cooler will not reach the desired temperature.	The cooler is placed too close to a heat source.	Keep the cooler away from direct sunlight or other heat sources.
	The cooler does not have sufficient ventilation.	Read and follow the "Installation Clearance Requirements" section.
	The door is opened too frequently or for long periods of time.	Close the door tightly and do not open the door too frequently or for long periods of time.

ISSUE	POSSIBLE CAUSE	SOLUTION
The wine cooler is making strange noises.	Certain sounds are normal	Read the “Normal Sounds” section.
	The unit is not level or is touching another appliance.	Check to make sure the cooler is level and that it is not in contact with another appliance or furniture.
The body of the wine cooler is electrified.	The unit is not properly grounded.	Contact your local electrician to test your electrical grounding system.
Frost is forming in the wine cooler.	The environment is humid.	Through the unit uses an “auto-defrost” system, under certain conditions, manual defrosting may be required. If frost builds up, you can try running the cooler on a warmer temperature setting, minimizing the number of times you open the door, or unplugging the unit to allow the frost to melt.
	The ambient temperature is too low.	
	The door is being opened too frequently.	
The door will not shut properly.	The cooler is not level.	Make sure the cooler is on a level surface.
	The door gasket is dirty.	Clean the door gasket.
	The door gasket is not installed correctly.	Make sure the door gasket is properly installed.
	The shelves are incorrectly installed.	Install the shelves correctly.

# Specifications

DESCRIPTION OF PRODUCT	Single Zone Built-In Wine Refrigerator
MODEL	<b>AWC242TSZRH / AWC242TSZLH</b>
VOLTAGE / FREQUENCY	AC 115 / 60 Hz
AMPERAGE	2.5 A
INPUT POWER	220 W
COLOR	Black Cabinet with Stainless Steel Door
STORAGE CAPACITY	151 Bottles*
REFRIGERANT	R600a, 50g / 1.77oz
TEMPERATURE RANGE	40° F to 65° F
DIMENSIONS (HEIGHT X WIDTH X DEPTH)	69 <sup>7</sup> / <sub>16</sub> " X 23 <sup>7</sup> / <sub>16</sub> " X 28 <sup>7</sup> / <sub>16</sub> " **
WEIGHT	256 Pounds / 116 kgs



Note: Technical data and performance information are provided for reference only. Specifications are subject to change. Check the rating label on the wine refrigerator for the most accurate information.

\*The storage capacity is based on standard 750 ml. wine bottles.

\*\* Depth includes handle. Depth without handle is 26 <sup>11</sup>/<sub>16</sub>".