



SIMPSON
Dura-Vent

DVL

Applications

Double-wall interior stovepipe for connecting wood stoves to manufactured chimney.

Materials and Construction

.016" stainless steel inner wall.
.018" galvanized outer, painted black.

Clearances

6" clearance to walls. 8" clearance to ceilings, including cathedral ceilings.

Diameters

6", 7", and 8".

Listings

c-UL-us listed to ULC S641 (MH14089).



DuraBlack

Applications

Single-wall interior stovepipe for connecting wood stoves to manufactured chimney.

Materials and Construction

24-gauge steel construction.
Lock-seamed. Painted black.

Clearances

18" clearance to combustibles.

Diameters

6", 7", 8", and 10".

DVL double-wall or DuraBlack single-wall stovepipe completes the venting system when used with one of Simpson Dura-Vent's chimney products, such as DuraTech, DuraPlus, or DuraPlus HTC.

DVL

DVL's double-wall, air-insulated design reduces clearances to combustibles from 18" to 6", the closest clearance to a wall of any connector pipe. DVL improves stove performance by maintaining high flue gas temperatures for a strong, steady draft. Because the inner wall is stainless steel the flue heats up faster, stays hot longer, minimizes the formation of creosote, and has the same life expectancy as the chimney. Adjustable lengths eliminate the need for cutting or crimping.

Required for Manufactured Home installations. See appliance manufacturer's installation instructions.

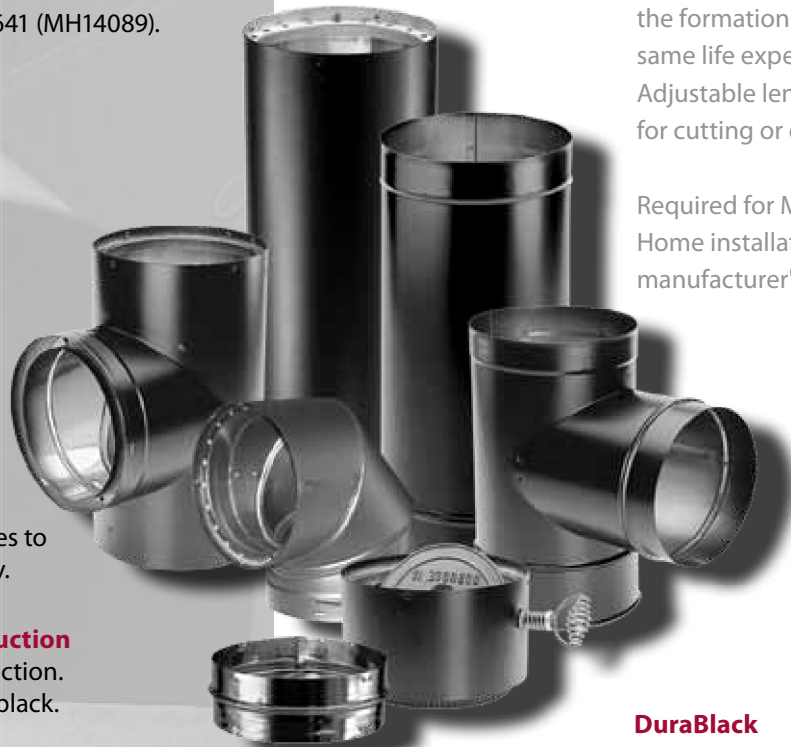

DuraBlack

For an economical, drip free, single-wall stovepipe, DuraBlack is an excellent choice. Built to Simpson Dura-Vent's high standards, DuraBlack is constructed with die-formed end fittings. Adjustable lengths eliminate the need for cutting and crimping.

DVL – Close Clearance Connector, Double-Wall Stovepipe

DVL Close Clearance Connector Kit



Kit includes: DVL/DuraBlack Adapter, (2) 24" DVL Double-Wall Black Pipe, 12" DVL double-wall Adjustable Black Pipe.

Use kit to connect between appliance and chimney for a typical 8' through-the-ceiling installation.

| | |
|---------|------|
| SIZE | 6" |
| STOCK # | 8693 |

DVL/DuraBlack Chimney Adapter

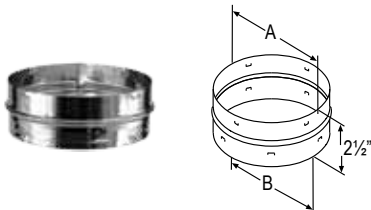

Use to connect from double-wall DVL and/or single-wall DuraBlack to DuraTech, DuraPlus, DuraPlus HTC, and DuraLiner for a through-the-wall or ceiling support installation. Required for proper connection. Made of stainless steel.

| SIZE | 6" | 7" | 8" |
|---------|--------|--------|--------|
| A | 6 1/8" | 7 1/8" | 8 1/8" |
| B | 6" | 7" | 8" |
| STOCK # | 8674 | 8774 | 8874 |

DVL Double-Wall Black Pipe

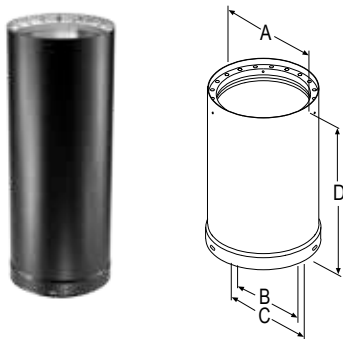

Designed for installation with minimum clearance to combustibles (6" to walls, 8" from top of horizontal run to ceiling). Available in 6", 7", and 8" diameters. Subtract 3/4" for installed length. Constructed with a stainless steel inner wall.

| SIZE | 6" | 7" | 8" |
|------------|--------------------------|--------|--------|
| A | 7" | 8" | 9" |
| B | 6" | 7" | 8" |
| C | 7 1/8" | 8 1/8" | 9 1/8" |
| D | 6", 12", 18", 24", & 36" | | |
| 6" LENGTH | 8606 | 8706 | 8806 |
| 12" LENGTH | 8612 | 8712 | 8812 |
| 18" LENGTH | 8618 | 8718 | 8818 |
| 24" LENGTH | 8624 | 8724 | 8824 |
| 48" LENGTH | 8648 | 8748 | 8848 |

DVL Double-Wall Adjustable Black Pipe

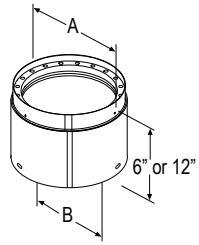

Use to add length to DVL pipe. 6" pipe adds 2"-5" of length, 12" pipe adds 2"-10" of length, when used with rigid sections of pipe. 12" section can be ovalized for oval-to-round appliance connector.

| SIZE | 6" | 7" | 8" |
|-------------|------|------|------|
| A | 7" | 8" | 9" |
| B | 6" | 7" | 8" |
| 6" STOCK # | 8685 | 8785 | 8885 |
| 12" STOCK # | 8687 | 8787 | 8887 |

DVL Telescoping Length

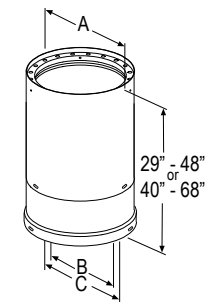

Use for a two-piece installation from stove to ceiling support box or finishing collar. Available in 29"- 46" and 40"- 68" extensions. No cutting required.

| SIZE | 6" | 7" | 8" |
|-----------|--------|--------|--------|
| A | 7" | 8" | 9" |
| B | 6" | 7" | 8" |
| C | 7 1/8" | 8 1/8" | 9 1/8" |
| 29" - 46" | 8646 | 8746 | 8846 |
| 40" - 68" | 8647 | 8747 | 8847 |

DVL Double-Wall Black 45° Elbow

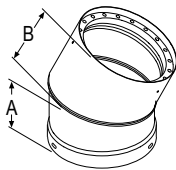

Offsets obstructions as needed. Not adjustable.

| SIZE | 6" | 7" | 8" |
|---------|--------|--------|--------|
| A | 5 1/4" | 5 3/8" | 5 3/8" |
| B | 4 1/2" | 4 1/2" | 4 1/2" |
| STOCK # | 8645 | 8745 | 8845 |

DVL Double-Wall Black 90° Elbow

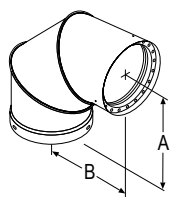

Offsets obstructions as needed. Not adjustable. Not recommended for rear exit appliances.

| SIZE | 6" | 7" | 8" |
|---------|--------|--------|--------|
| A | 6" | 8 1/2" | 8 1/2" |
| B | 7 1/2" | 7 3/4" | 7 7/8" |
| STOCK # | 8690 | 8790 | 8890 |

DVL In increaser

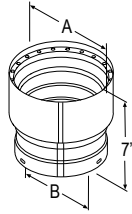

Use to increase from a smaller appliance flue outlet to larger diameter chimney or stovepipe.

| SIZE | 5" - 6" | 6" - 7" | 7" - 8" | 6" - 8" |
|---------|---------|---------|---------|---------|
| A | 6" | 7" | 8" | 8" |
| B | 5 1/8" | 6" | 7" | 6" |
| STOCK # | 8667 | 8767 | 8867 | 8860 |

DVL Double-Wall Black Tee w/ Clean-out Cap

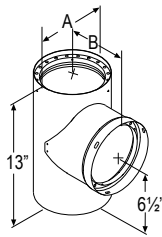

Use with rear exit appliances and appliances that require a barometric damper.

| SIZE | 6" | 7" | 8" |
|---------|------|------|------|
| A | 7" | 8" | 9" |
| B | 6" | 7" | 8" |
| STOCK # | 8655 | 8755 | 8855 |

DVL Adapter/Damper Section

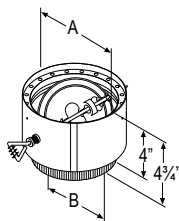

Connects DVL pipe to the appliance flue outlet. Use as a stove adapter. The damper is optional. Stock # with (W/O) has no damper.

| SIZE | 6" | 7" | 8" |
|-------------|--------|--------|--------|
| A | 7" | 8" | 9" |
| B | 5 5/8" | 6 1/2" | 7 1/2" |
| STOCK # | 8679 | 8779 | 8879 |
| STOCK # W/O | 8680 | 8780 | 8880 |

DVL Oval-To-Round Adapter

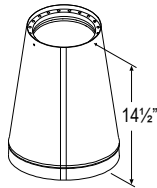

Use on Vermont Casting appliances with oval flue collars to adapt to round pipe.

| SIZE | 8" OVAL TO 6" ROUND | 8" OVAL TO 8" ROUND |
|---------|---------------------|---------------------|
| STOCK # | 8670 | 8870 |

Masonry Thimble w/ Slip Connector

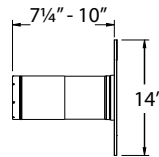

Penetrates masonry chimney for connection of DuraBlack or DVL to DuraLiner. Adapter must be used to attach the connector pipe to the masonry thimble. Pricing for Masonry Thimble with Slip connector listed under DuraLiner.

| SIZE | STOCK # |
|------|---------|
| 6" | 4643 |
| 8" | 4843 |

DURABLACK - Single-Wall Stovepipe

DuraBlack Stovepipe Kit



Kit includes: 14" DuraBlack Slip Connector, (2) 24" DuraBlack Single-Wall Black Pipe, and Trim Collar.

Use kit to connect between appliance and chimney for a typical 8' through-the-ceiling installation.

| | |
|---------|------|
| SIZE | 6" |
| STOCK # | 1692 |

NEW DuraBlack Slip Connector

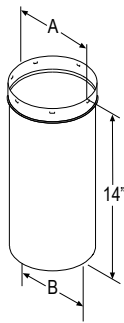

Use to adapt DuraBlack pipe to ceiling support box or finishing collar. Adds 3" - 13" of length to rigid pipe. Allows drip-free installation without cutting the pipe. Can be used in line to create a telescoping combination when used with a straight length of pipe. 10" connector requires screws.

| SIZE | 6" | 7" | 8" | 10" |
|------------|----------|----------|----------|----------|
| A | 6 3/16" | 7 3/16" | 8 3/16" | 10 3/16" |
| B | 5 15/16" | 6 15/16" | 7 15/16" | 9 15/16" |
| SS STOCK # | 1670SS | -- | 1870SS | -- |
| STOCK # | 1670 | 1770 | 1870 | 2070 |

NEW DuraBlack Telescoping Length

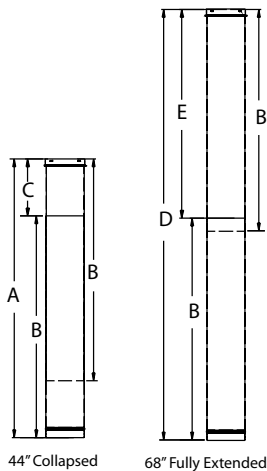

Use for a two-piece installation. Connects directly from stove to ceiling support box or finishing collar. Adjusts from 44" - 68". No cutting required. Available in stainless steel (SS).

| SIZE | 6" |
|------------|--------|
| A | 44" |
| B | 35" |
| C | 9" |
| D | 68" |
| E | 33" |
| SS STOCK # | 1647SS |
| STOCK # | 1647 |

Snap-Lock Adapter

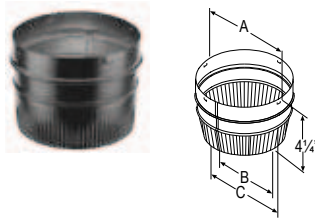

Snaps into the ceiling support box or finishing collar and extends down to fit into stovepipe for a drip-free connection to a DuraTech, DuraPlus, DuraPlus HTC, or DuraLiner Chimney system. Painted black.

| SIZE | 5" | 6" | 7" | 8" |
|---------|---------|---------|---------|---------|
| A | 5 3/16" | 6 3/16" | 7 3/16" | 8 3/16" |
| B | 4 1/2" | 5 1/2" | 6 1/2" | 7 1/2" |
| C | 4 5/16" | 5 5/16" | 6 5/16" | 7 5/16" |
| STOCK # | 6589 | 6689 | 6789 | 6889 |

DuraBlack Slip Increaser

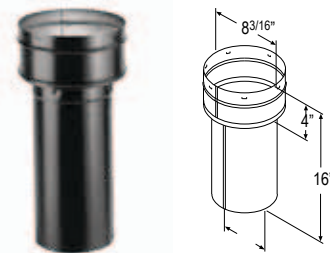

Use to adapt from 6" DuraBlack to 8" DuraTech, DuraPlus, DuraPlus HTC, or Duraliner at the ceiling support box or finishing collar. Adds 5" - 15" of length.

| SIZE | 6"- 8" |
|---------|--------|
| STOCK # | 1860 |

NEW DuraBlack Single-Wall Black Pipe

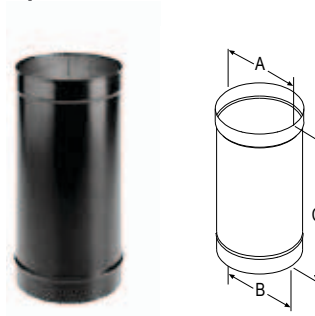

Use for a single-wall connector pipe. Requires 18" clearance to combustibles. Subtract 1 1/4" from the "C" measurement to calculate the installed length.

| SIZE | 6" | 7" | 8" | 10" |
|---------------|------------------|--------|--------|---------|
| A | 6 1/8" | 7 1/8" | 8 1/8" | 10 1/8" |
| B | 6" | 7" | 8" | 10" |
| C | 12", 24", or 48" | | | |
| 12" SS LENGTH | 1612SS | -- | 1812SS | -- |
| 12" LENGTH | 1612 | 1712 | 1812 | 2012 |
| 24" SS LENGTH | 1624SS | -- | 1824SS | -- |
| 24" LENGTH | 1624 | 1724 | 1824 | 2024 |
| 48" SS LENGTH | 1648SS | -- | 1848SS | -- |
| 48" LENGTH | 1648 | 1748 | 1848 | -- |

DuraBlack Increaser

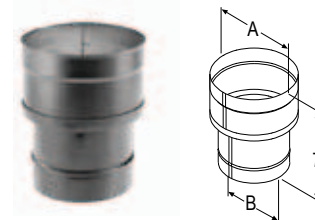

Use to increase from a smaller appliance flue outlet to a larger diameter chimney or stovepipe.

| SIZE | 5"- 6" | 6"- 7" | 7"- 8" | 8"- 10" | 9"- 10" |
|---------|--------|--------|--------|---------|---------|
| A | 6 1/8" | 7 1/8" | 8 1/8" | 10 1/8" | 10 1/8" |
| B | 5" | 6" | 7" | 8" | 9" |
| STOCK # | 1667 | 1767 | 1867 | 2067 | 2069 |

NEW DuraBlack Tee w/
Clean-Out Cap

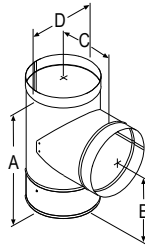

Use with rear exit appliances and appliances that require a barometric damper.

| SIZE | 6" | 7" | 8" | 10" |
|------------|---------|---------|---------|---------|
| A | 10 1/2" | 11 1/2" | 12 1/2" | 14" |
| B | 6 3/8" | 7" | 7 1/4" | 8 1/4" |
| C | 5 3/4" | 6" | 7" | 8" |
| D | 6 1/8" | 7 1/8" | 8 1/8" | 10 1/8" |
| SS STOCK # | 1655SS | -- | 1855SS | -- |
| STOCK # | 1655 | 1755 | 1855 | 2055 |

NEW DuraBlack 45° Elbow

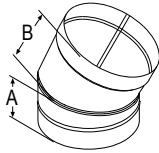

Offsets obstructions as needed. Not adjustable.

| SIZE | 6" | 7" | 8" | 10" |
|------------|--------|--------|--------|--------|
| A | 4 3/8" | 4 5/8" | 4 3/8" | 4 1/2" |
| B | 3 3/8" | 3 1/4" | 3 1/2" | 3 5/8" |
| SS STOCK # | 1645SS | -- | 1845SS | -- |
| STOCK # | 1645 | 1745 | 1845 | 2045 |

NEW DuraBlack 90° Elbow

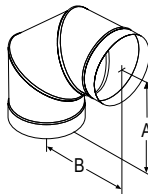

Offsets obstructions as needed. Not adjustable. Not recommended for rear exit appliances.

| SIZE | 6" | 7" | 8" | 10" |
|------------|--------|--------|--------|--------|
| A | 7 3/4" | 8 1/4" | 8" | 7 1/2" |
| B | 7" | 6 3/4" | 6 3/4" | 7" |
| SS STOCK # | 1690SS | -- | 1890SS | -- |
| STOCK # | 1690 | 1790 | 1890 | 2090 |

DuraBlack Damper Section

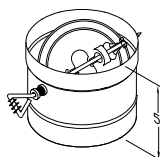

Install at, or close to, the stove outlet in-line. 5" pipe section with the damper pre-installed.

| SIZE | 6" | 7" | 8" |
|---------|------|------|------|
| STOCK # | 1605 | 1705 | 1805 |

DuraBlack Oval to Round Adapter

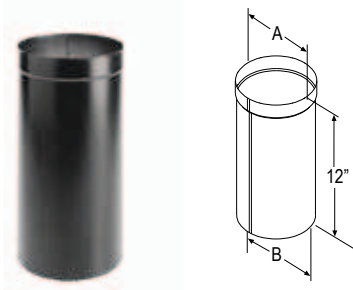

Connects to the oval flue outlet of the appliance. Must be field ovalized.

| SIZE | 6" | 7" | 8" |
|---------|----------|----------|----------|
| A | 6 1/8" | 7 1/8" | 8 1/8" |
| B | 5 15/16" | 6 15/16" | 7 15/16" |
| STOCK # | 1675 | 1775 | 1875 |

DuraBlack Double-Skirted Stovetop Adapter

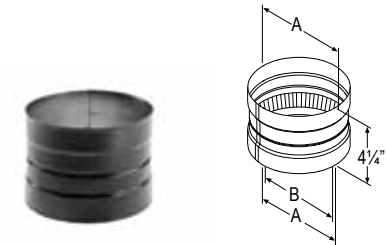

Use to adapt DuraBlack stovepipe to appliance flue outlets. Outer wall covers appliance flue outlet.

| SIZE | 6" | 7" | 8" | 10" |
|---------|--------|--------|--------|---------|
| A | 6 1/8" | 7 1/8" | 8 1/8" | 10 1/8" |
| B | 5 5/8" | 6 5/8" | 7 5/8" | 9 5/8" |
| STOCK # | 1672 | 1772 | 1872 | 2072 |

NEW DuraBlack Stovetop Adapter

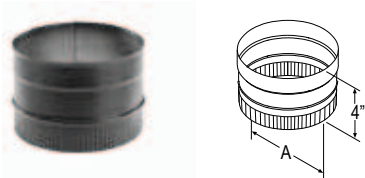

Use to adapt DuraBlack stovepipe to appliance flue outlet.

| SIZE | 6" | 7" | 8" |
|------------|----------|----------|----------|
| A | 5 15/16" | 6 15/16" | 7 15/16" |
| SS STOCK # | 1677SS | -- | 1877SS |
| STOCK # | 1677 | 1777 | 1877 |

| METRIC ADAPTER | |
|----------------|------|
| STOCK # | 4706 |

DuraBlack Trim Collar

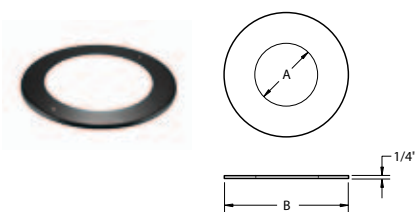

Use as a decorative Trim Collar for DuraBlack connection to chimney.

| SIZE | 6" | 7" | 8" | 10" |
|---------|--------|--------|--------|---------|
| A | 6 1/8" | 7 1/8" | 8 1/8" | 10 1/8" |
| B | 9" | 10" | 11" | 13" |
| STOCK # | 1668 | 1768 | 1868 | 2068 |

Offset Chart - DVL

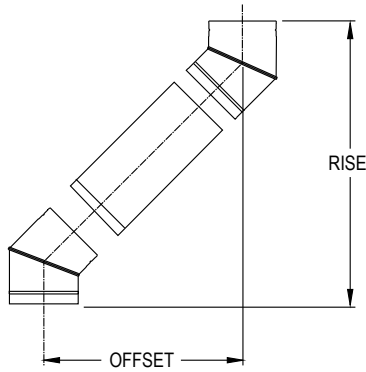

| SIZE | | 6" DIAMETER | | 7" DIAMETER | | 8" DIAMETER | |
|---------------|-----------------|---------------|-------------|---------------|-------------|---------------|-------------|
| Elbow Degrees | Chimney Section | Offset Inches | Rise Inches | Offset Inches | Rise Inches | Offset Inches | Rise Inches |
| 45° | 0" | 4 1/2" | 12 1/16" | 4 5/8" | 12 1/2" | 6 1/4" | 16 3/8" |
| 45° | 6" | 7 7/8" | 15 3/8" | 8" | 15 7/8" | 9 3/8" | 19 3/4" |
| 45° | 12" | 12 3/32" | 19 5/8" | 12 1/4" | 20 1/8" | 13 7/8" | 24" |
| 45° | 18" | 16 5/16" | 23 7/8" | 16 1/2" | 24 3/8" | 18 1/8" | 28 1/4" |
| 45° | 24" | 20 9/16" | 28 1/8" | 20 3/4" | 28 5/8" | 22 3/8" | 32 3/8" |
| 45° | 48" | 37 1/2" | 45 1/8" | 37 3/4" | 45 5/8" | 39 1/4" | 49 3/8" |
| 90° | 0" | 11 1/8" | 12 3/8" | 12 3/4" | 14" | 13 3/4" | 15" |
| 90° | 6" | 15 3/8" | 12 3/8" | 17 1/2" | 14" | 18 1/2" | 15" |
| 90° | 12" | 21 7/8" | 12 3/8" | 23 1/2" | 14" | 24 1/2" | 15" |
| 90° | 18" | 27 7/8" | 12 3/8" | 29 1/2" | 14" | 30 1/2" | 15" |
| 90° | 24" | 33 7/8" | 12 3/8" | 35 1/2" | 14" | 36 1/2" | 15" |
| 90° | 48" | 57 7/8" | 12 3/8" | 59 1/2" | 14" | 60 1/2" | 15" |

Offset Chart - DuraBlack

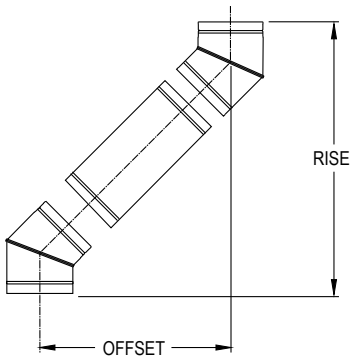

| SIZE | | 6" DIAMETER | | 7" DIAMETER | | 8" DIAMETER | | 10" DIAMETER | |
|---------------|-----------------|---------------|-------------|---------------|-------------|---------------|-------------|---------------|-------------|
| Elbow Degrees | Chimney Section | Offset Inches | Rise Inches | Offset Inches | Rise Inches | Offset Inches | Rise Inches | Offset Inches | Rise Inches |
| 45° | 0" | 5 1/2" | 14 1/2" | 5 1/2" | 14 3/4" | 5 1/2" | 14 3/4" | 5 3/4" | 15" |
| 45° | 12" | 13" | 22" | 13 1/4" | 22 1/4" | 13 1/4" | 22 1/4" | 13 1/4" | 22 3/4" |
| 45° | 24" | 21 1/2" | 30 1/2" | 21 3/4" | 30 3/4" | 21 3/4" | 30 3/4" | 21 3/4" | 31 1/4" |
| 45° | 48" | 38 1/2" | 44 1/2" | 38 3/4" | 47 3/4" | 38 3/4" | 47 3/4" | -- | -- |
| 90° | 0" | 14 3/4" | 16" | 15" | 16 1/4" | 14 3/4" | 16" | 14 1/2" | 16 3/4" |
| 90° | 12" | 25 1/2" | 16" | 25 3/4" | 16 1/4" | 25 1/2" | 16" | 25 1/4" | 16 3/4" |
| 90° | 24" | 37 1/4" | 16" | 37 3/4" | 16 1/4" | 37 1/4" | 16" | 37 1/4" | 16 3/4" |
| 90° | 48" | 61 1/2" | 16" | 61 1/4" | 16 1/4" | 61 1/2" | 16" | -- | -- |

