

Family: Casa | Item No. 4311 OL

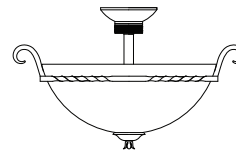

▼ start here

Drawing 1 - Strap Detail

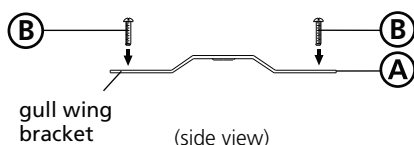

1

1. Find a clear area in which you can work.
2. Unpack fixture and glass from carton.
3. Carefully review instructions prior to assembly.

Drawing 2 - Fixture Mounting

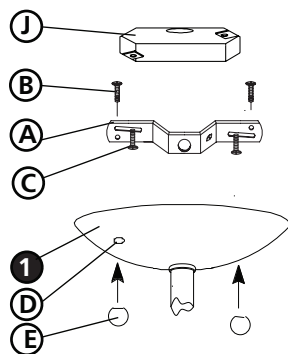

2

***** The construction of this fixture will be accomplished by first mounting the mounting strap to the junction box, making all necessary electrical connections, hanging the fixture from the ceiling, and then installing the glass.**

1. Prepare gem strap (A) for mounting by threading two screws (B) provided into back of gull wing bracket of gem strap (A) - see **Drawing 1**.
 - Be sure the holes into which the screws are threaded match the spacing of holes (D) in the ceiling pan (1) - see **Drawings 1 and 2**.
2. Mount gem strap (A) to junction box (J), using the two 1" screws (C).

Drawing 3 - Glass Installation

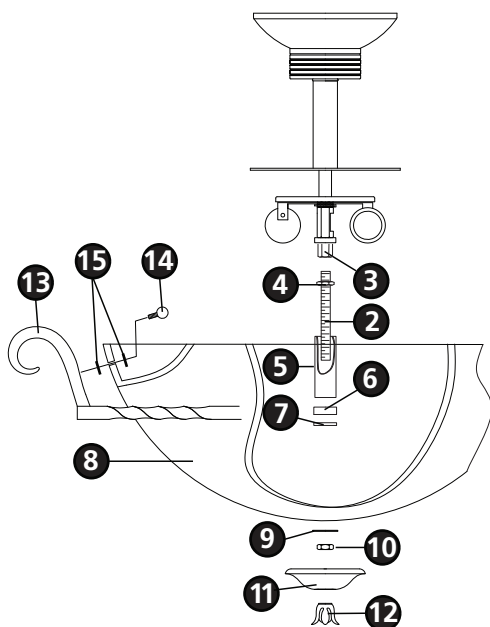

3

Make electrical connections from supply wire to fixture lead wires. Refer to instruction sheet (I.S. 18) and follow all instructions to make all necessary wiring connections. Then refer back to this sheet to continue installation of this fixture.

4

1. Hang the fixture by slipping the mounting holes (D) in the canopy over screws (B), mounted in strap (A) previously - see **Drawing 2**.
2. Thread ball knobs (E) onto end of screw (C) and tighten to secure fixture.

5

1. Prior to installing glass (8) attach ring (13) using ball knob studs (14). Line up holes in glass with holes on inside of ring and thread in ball knob studs to secure ring. Making sure to place a plastic washer (15) on each side of the glass.
2. To install glass, thread center stem (2) into coupler (3) approximately 3/8" - see **Drawing 3**.
3. Thread hex nut (4) up against coupler (3) to secure center stem (2).
4. Slip tube (5) followed by cap (6) and rubber washer (7) over center stem (2).
5. Fixture can now be lamped accordingly.
6. Slip glass (8) followed by flat washer (9) onto center stem (2) and hold in position.
7. Thread hex nut (10) on center stem (2) to secure glass (8).
8. Slip cap (11) onto center stem and hold in position.
9. Thread knob (12) onto end of center stem (2) and tighten.

Drawing 1 - Flush Mount

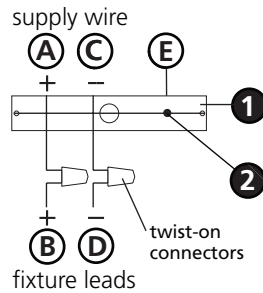

Drawing 2 - Chain Hung

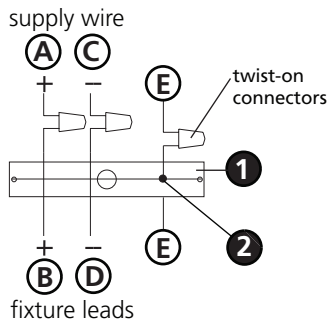

Drawing 3 - Post-Mount

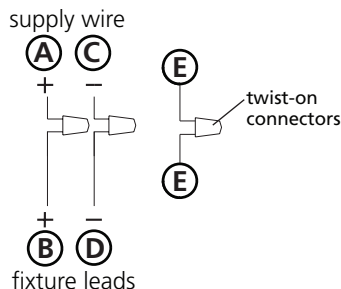

SAFETY WARNING: READ WIRING AND GROUNDING INSTRUCTIONS (I.S. 18) AND ANY ADDITIONAL DIRECTIONS. TURN POWER SUPPLY OFF DURING INSTALLATION. IF NEW WIRING IS REQUIRED, CONSULT A QUALIFIED ELECTRICIAN OR LOCAL AUTHORITIES FOR CODE REQUIREMENTS.

wiring instructions

Indoor Fixtures

1. Connect positive supply wire **(A)** (typically black or the smooth, unmarked side of the two-conductor cord) to positive fixture lead **(B)** with appropriately sized twist on connector - see **Drawings 1 or 2**.
2. Connect negative supply wire **(C)** (typically white or the ribbed, marked side of the two-conductor cord) to negative fixture lead **(D)**.
3. Please refer to the **grounding instructions** below to complete all electrical connections.

Outdoor Fixtures

1. Connect positive supply wire **(A)** (typically black or the smooth unmarked side of the two-conductor cord) to positive fixture lead **(B)** with appropriately sized twist on connector - see **Drawings 2 or 3**.
2. Connect negative supply wire **(C)** (typically white or the ribbed, marked side of the two-conductor cord) to negative fixture lead **(D)**.
3. Cover open end of connectors with silicone sealant to form a watertight seal.
 - If installing a wall mount fixture, use caulk to seal gaps between the fixture mounting plate (backplate) and the wall. This will help prevent water from entering the outlet box. If the wall surface is lap siding, use caulk and a fixture mounting platform specially.
4. Please refer to the **grounding instructions** below to complete all electrical connections.

grounding instructions

Flush Mount Fixtures

For positive grounding in a 3-wire electrical system, fasten the fixture ground wire **(E)** (typically copper or green plastic coated) to the fixture mounting strap **(1)** with the ground screw **(2)** - see **Drawing 1**.

Note: On straps for screw supported fixtures, first install the two mounting screws in strap. Any remaining tapped hole may be used for the ground screw.

Chain Hung Fixtures

Loop fixture ground wire **(E)** (typically copper or green plastic coated) under the head of the ground screw **(2)** on fixture mounting strap **(1)** and connect to the loose end of the fixture ground wire directly to the ground wire of the building system with appropriately sized twist-on connectors - see **Drawing 2**.

Post-Mount Fixtures

Connect fixture ground wire **(E)** (typically copper or green plastic coated) to power supply ground with appropriately sized twist-on connector inside post. Cover open end of connector with silicone sealant to form a watertight seal - see **Drawing 3**.