

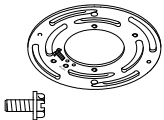







Fixture Name: Cercado 9018-1W COB

This fixture assembled PO: _____ Date: _____

Notice: Please review the parts listing and check for all parts before assembling the fixture. If any parts are missing or damaged, please note on this sheet and contact the place of purchase to arrange for replacement parts.

PARTS LIST		Company Name: _____ Co. Account #: _____ below to be filled out by retailer	
Circular Mounting Strap 1ea $\Phi 4'' \times H1.2\text{mm}$		Mounting screw 2ea 8/32-IP*1"	
Hex nut 2ea 5/32-IP*H3mm		Wire connector 2ea A3 Orange	
Bulb 1ea GU24		Spanner (allen wrench) 1 ea L2-3/8" *W3/4"	
		Mounting screw 2ea 5/32-IP*1-1/4"	
		Deco nuts 2ea 5/32-IP*H9mm	
		Deco screw w/ rubber washer 2ea 5/32-IP*H9mm	
Part Needed _____			Quantity _____
Part Needed _____			Quantity _____
Reason why _____	(missing, scratched, broken glass, bent, bad finish)		
Comments _____			

FIXTURE ASSEMBLY INSTRUCTIONS

Read and review installation instruction sheet before assembling the fixture.

- Place the Glass (G) between the outer decorative ring and the back Frame (E), and tighten in place with Deco nuts (H) that includes a rubber washer until snug.
- Install the light bulb in accordance with the fixture's specification.

2 YEAR LIMITED WARRANTY

ENERGY STAR-qualified indoor lighting fixtures are offered, by Golden Lighting, a two (2) year limited warranty beginning on the date of the sales transaction. This warranty includes the repair or replacement of the fixture housing, optics, trim and electrical components (excluding the lamp).

Warning: When re-lamping, please use UL and CUL Listed Self-Ballast Fluorescent Lamp
Note: Compact Fluorescent bulb contains Mercury
 Dispose of according to local, State & Federal Law
 1-800-555-5629 www.lamprecycle.org

NOTE: INSTALL THE GLASS ASSEMBLY AFTER THE FIXTURE IS HUNG.

9018-1W COB

Fig 1

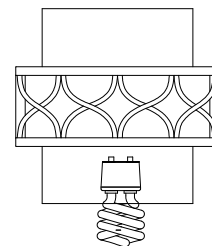
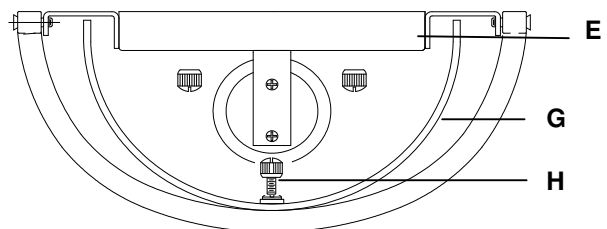

Bulb

Replace bulb with a mini spiral 13W GU24 base fluorescent bulb in accordance with the fixture's specifications.

For Customer Service, contact the place of purchase to arrange for replacement parts.

WARNING ! SHUT OFF POWER AT FUSE OR CIRCUIT BREAKER.

HANGING THE FIXTURE (Fig 1)

1. Carefully remove the new fixture from the carton and the yellow bag that holds all your parts. Check that all parts are included as shown in the illustration and parts list.
2. Shut off power at the circuit breaker and remove the old fixture from wall, including the old mounting strap.
3. The Mounting Strap (B) contains several pairs of threaded holes, find the pair of holes that match the holes spacing in your fixture Back Plate (E) and thread the two Fixture Mounting Screws (C) half way into the Fixture Mounting Strap (B).
4. Place the Mounting Strap (B) over the Junction Box so the Fixture Mounting Screws (C) are vertical or horizontal, as required by the fixture type.
5. Attach the Fixture Mounting Strap (B) to the Junction Box using the two mounting screws (A). Tighten the screws (A) securely with screwdriver.

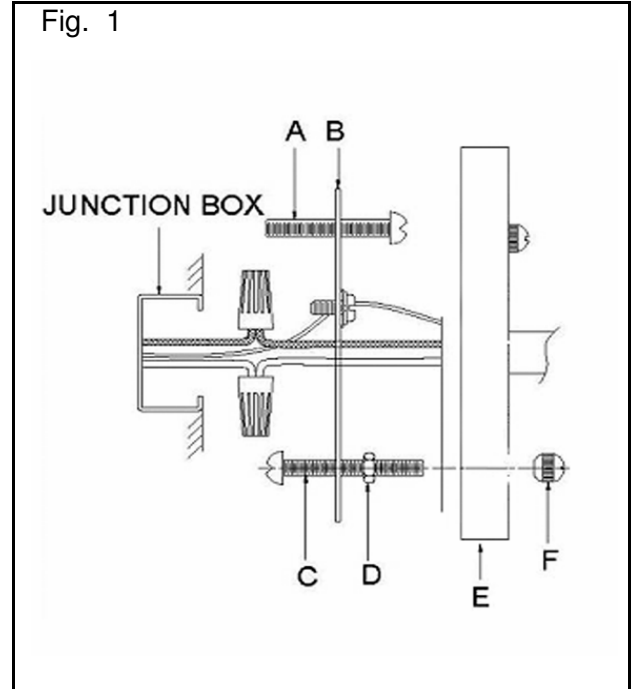

CONNECTING THE WIRES (Fig 2)

6. Attach the power supply wires to the fixture lead wires by connecting BLACK to BLACK (or SMOOTH) and WHITE to WHITE (or RIBBED).
 7. Attach the GROUND wire (GREEN or COPPER) from the Junction Box and the fixture Ground wire to the green Ground Screw on the Mounting Bracket (B) or connect both wires together using the correct size of wire connectors.
- NOTE: Twist the wires together in the same direction you twist the wire connector onto the wires.
8. Tuck these wire connections neatly into the Junction Box.

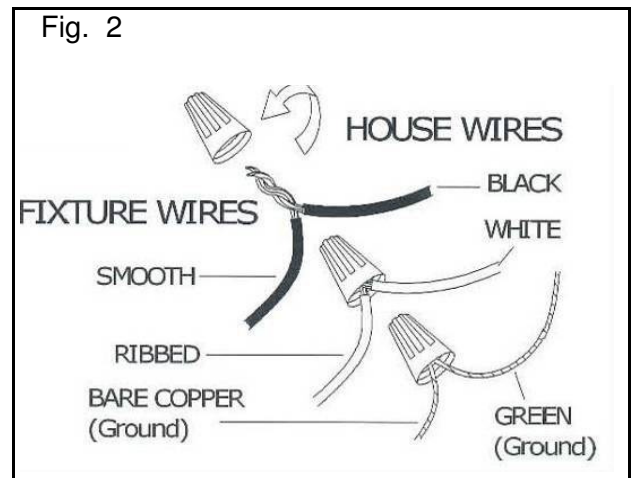

FINISHING THE INSTALLATION (Fig 3)

9. Place the fixture Back Plate (E) over the two Mounting Screws (C) and secure the Back Plate (E) against the wall by threading two Deco nuts (F) over the two Mounting Screws (C) until tight as shown on Fig.1

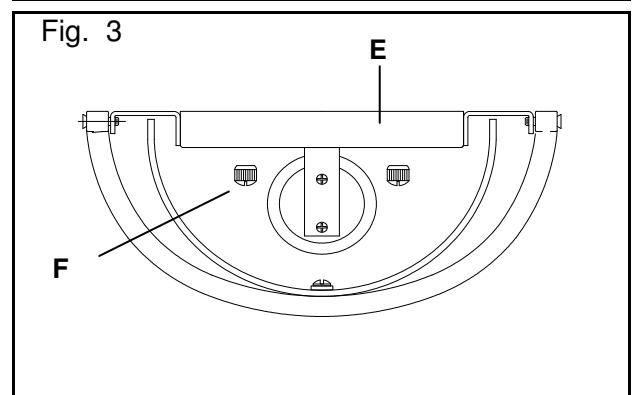

YOUR INSTALLATION IS NOW COMPLETE. RETURN POWER TO THE JUNCTION BOX AND TEST THE FIXTURE.