

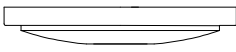









Fixture Name: TREILLE 8989-9 PC

This fixture assembled PO: \_\_\_\_\_ Date: \_\_\_\_\_

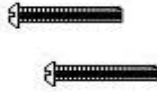
**Notice:** Please review the parts listing and check for all parts before assembling the fixture. If any parts are missing or damaged, please note on this sheet and contact the place of purchase to arrange for replacement parts.

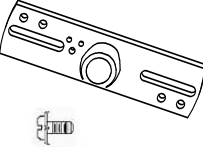
<b>PARTS LIST</b>		Company Name: _____ Co. Account #: _____ to be filled out by retailer	
Canopy 1 ea 5.125"Dia*.875"E 	Hex nut 2 ea 1/2"*H3mm 	Nipple 1 ea 1/2"*H40mm 	
Chain 1 ea 6ft*3.8mm 	Wire connector 2 ea A3 Orange 	Top loop 1 ea 3/8-IP*H58mm 	
Chain connector 2 ea Φ5*H58mm 	Mounting screw 2 ea 8/32"*1" 	Canopy loop 1 ea 1/2"*H46mm 	
Mounting strap w/ ground screw 1 ea 1" *4" w/ Φ1/2"center 	Washer 1 ea 8/32"*1" 	Canopy loop collar 1 ea Φ7/8"ID*H4mm 	
Part Needed _____	Quantity _____		
Part Needed _____	Quantity _____		
Reason why _____	( missing, scratched, broken glass, bent, bad finish)		
Comments _____			

**FIXTURE ASSEMBLY INSTRUCTIONS**  
**Read and review installation instruction sheet before assembling the fixture.**

\* NOTE: The Finial can be scratched or broken if the full weight of the fixture is placed on it. To avoid damage assemble fixture on a cushioned surface.

1. Gently spread the arms until evenly spaced if arms are packed closed.
2. Feed the fixture wires through the Top loop (B1) and pull the wires until taut.
3. Then screw the Top Loop (B1) to the Nipple (B2) at top of Frame until tight.

**NOTE: INSTALL THE GLASS ASSEMBLY AFTER THE FIXTURE IS HUNG.**

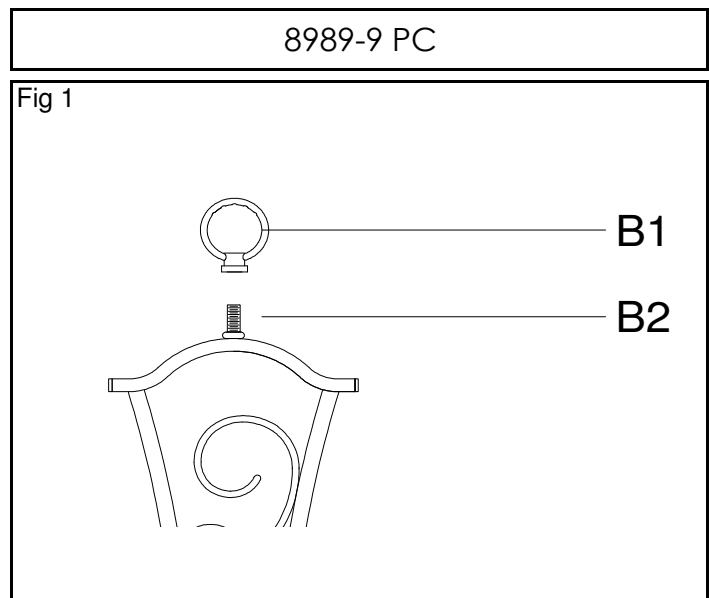

For Customer Service, contact the place of purchase to arrange for replacement parts.

# PARTS & ASSEMBLY SHEET continued

Fixture Name: TREILLE 8989-9 PC

4. By measuring determine correct number of links needed for proper hanging height. Use a pair of pliers to open one link of the Chain (C2) then remove the excess Chain (C2) and discard it.
  5. Use one chain connector(E2) to attach one end of the chain to the Top loop (D2) and close the chain connector.
  6. Feed the fixture wires through the Chain (every three links) and pull the wires until taut.
  7. Slip Canopy loop collar (B2) over the chain, then do the same with the canopy (F2).
  8. When ready to complete the installation Use the other chain connector and attach the other end of the chain to the canopy loop (A2) and close the chain connector.
  9. Make sure the weight of the chandelier is supported by the chain-not the electrical wire.
- \* You may now install the fixture.

Note: Complete these remaining steps after the fixture is hung.

10. Place the Glass Shade (C2) over the Threaded Socket (C1), place the Socket Ring (C3) over the Threaded Socket (C1)  
Secure the Glass Shade (C2) by threading by the Socket Ring (C3) until tight.

11. Install the light bulbs in accordance with the fixture's specifications.

(DO NOT EXCEED THE MAXIMUM WATTAGE RATING)

Fig 2

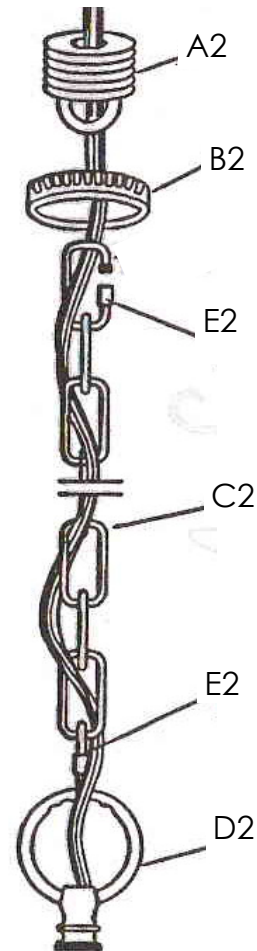
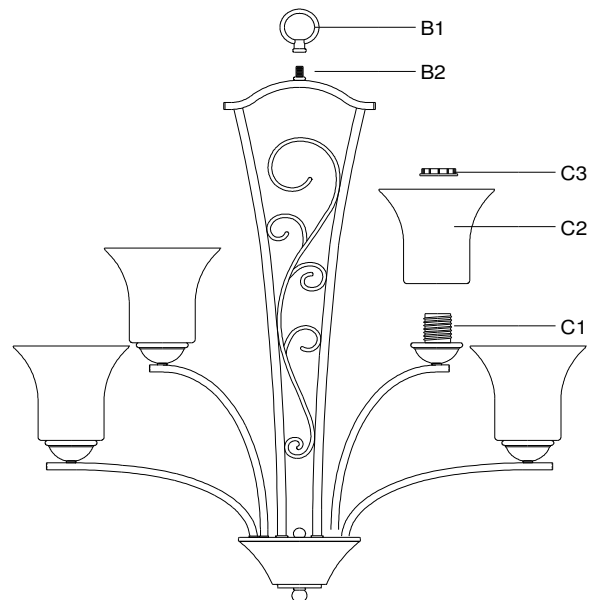

Fig 3



For Customer Service, contact the place of purchase to arrange for replacement parts.

## WARNING! SHUT OFF POWER AT FUSE OR CIRCUIT BREAKER.

### HANGING THE FIXTURE (Fig 1)

- Carefully remove the new fixture from the carton and the yellow bag that holds all parts. Check that all parts are included as shown in the illustration and parts list.
- Shut off the power at the circuit breaker and remove old fixture from ceiling, including the old mounting strap.
- Thread 2-1/8" Nipple(H) into Canopy loop (M) until snug. Thread Hex nut (F) and Washer (E) on next.
- Thread other end of the Nipple (H) with Canopy loop attached into Mounting strap (D) about 4 complete turns.
- Tighten the Washer (E) and Hex Nut (F) until tightening to the Mounting strap (D).
- Take this mounting strap assembly and mount to ceiling junction box with Mounting Screws (G). Tighten screws securely with screw driver.
- Unscrew the Canopy loop collar (J) from the Canopy loop. Take the canopy and pass over the Canopy loop (M). Approximately one half of the canopy loop exterior threads should be exposed. Adjust until desired height is reached. \*the Canopy loop collar should fit snugly on the Canopy loop after the canopy is installed. Remove Canopy and Canopy loop collar.
- Assemble the fixture and have an assistant or secure support hold the weight of the fixture while you complete the wiring connections.
- Thread the fixture wires and ground wire of the assembled fixture through the canopy loop and nipple and into the outlet box.

### CONNECTING THE WIRES (Fig 2)

- Attach the power supply wires to the fixture lead wires by connecting BLACK to BLACK (or SMOOTH) and WHITE to WHITE (or RIBBED).
  - Attach the GROUND wire (GREEN or COPPER) from the Junction Box and the fixture Ground wire to the green Ground Screw on the Mounting Bracket (D) or connect both wires together using the correct size of wire connectors.
- NOTE: Twist the wires together in the same direction you twist the wire connector onto the wires.
- Tuck these wire connections neatly into the Junction Box.

### FINISHING THE INSTALLATION

- Raise Canopy (I) to the ceiling and secure in place by tightening the Canopy loop collar (J) onto the Canopy Loop (M)
- Install the light bulbs and glass shade as per the fixture assembly sheet.

Fig. 1

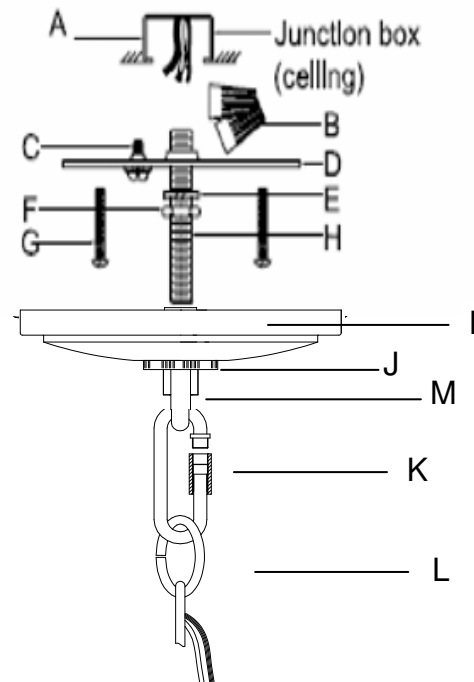
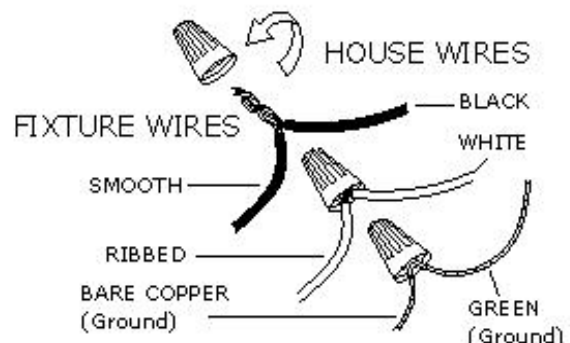

Fig. 2



**YOUR INSTALLATION IS NOW COMPLETE.  
RETURN POWER TO THE JUNCTION BOX AND  
TEST THE FIXTURE.**