

# CONTENTS

INTRODUCTION .....	1
MOUNTING RECOMMENDATIONS .....	2
FAN INSTALLATION .....	3
CONTROL FEATURES:	
3-SPEED OPERATION .....	7
TROUBLESHOOTING .....	9

## READ AND SAVE THESE INSTRUCTIONS

## SAFETY FIRST

**Safety and the proper operation of your Casablanca fan both require a thorough knowledge of the product and proper installation; therefore, before attempting to install and operate your Casablanca fan, read this owner's manual completely and carefully. Retain this manual for future reference.**

**CAUTION: To avoid possible electrical shock, make certain that electricity is turned off at the circuit breaker or fuse box before attempting any installation procedure.**

## BEFORE YOU START

- **CAUTION: RISK OF ELECTRICAL SHOCK!** All wiring must be performed in accordance with national and local electrical codes. If you are unfamiliar with the wiring codes, you should use a qualified electrician. To avoid overheating and possible damage to other equipment, do not install control to a receptacle, fluorescent light fixture, motor operated appliance, or transformer-supplied appliance.
- This fan is designed to be installed on an existing electrical outlet box. The outlet box must be UL Listed for ceiling fan installations, if it is not, a new box must be installed. Casablanca extension poles are available for sloped or high ceiling installations.
- This ceiling fan requires a grounded electrical supply of 120 VAC, 60 Hz and a minimum 15 amp circuit. The maximum current requirement for the fan with light fixture is 3.8 amps. The fan uses about 1 amp or 100 watts. Maximum light current is 2.8 amps or 340 watts of lighting.
- Where wire nuts are employed, be sure all bare wires are within the connectors. When installing the canopy hatch, make sure all wires are within the canopy and that no wires are being pinched.

**For best performance and for your warranty to be valid,  
use only genuine Casablanca blades, light fixtures, and accessories.**

## NOTES

- The blades in each pack are matched for equal weight to assure smooth fan operation. If more than one fan is being installed, be careful not to mix blades from different cartons.
- Inspect the contents of your carton for possible shipping or handling damage and report any such damage directly to your authorized Casablanca dealer.
- It is always a good idea to have an assistant to help with the installation.
- When cleaning, painting, or working near your fan, be very careful of the fan and blades. Always turn the power OFF to the ceiling fan before servicing it, working on it, or replacing light bulbs.
- Never insert anything into the path of the fan blades while the fan is in operation.
- Never install a fan over a pool or spa.
- Never operate a fan that has been damaged in any way. Contact Casablanca Fan Company by calling 1-888-227-2178, or contact your local authorized Casablanca dealer for assistance in obtaining service.

**FUSE BOX  
(REMOVE FUSE FOR THE  
CIRCUIT YOU WILL BE  
WORKING ON)**

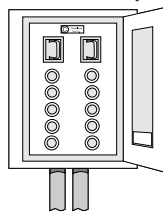

**CIRCUIT BREAKER  
(TRIP BREAKER FOR THE  
CIRCUIT YOU WILL BE  
WORKING ON)**

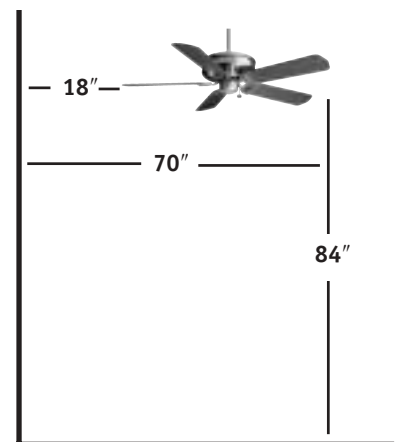
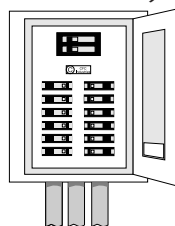

## MOUNTING RECOMMENDATIONS

Before mounting your Casablanca fan, read the following helpful recommendations. The location of the fan, air circulation, and fan size are all important factors to consider before installation.

### Location

Ceiling fans have practical uses in almost every room in your home. We suggest you follow these mounting recommendations as you decide where to install your Casablanca fan.

- For safety reasons, the fan blades must be a minimum of 7' above the floor.
- Do not locate the fan in a doorway or above a swinging door.
- In any installation, the tips of the blades must be at least 18" from the wall in order to provide sufficient clearance for the blades.
- In bedrooms, fans work best when mounted above the foot of the bed.
- In low ceiling locations, our optional Low Ceiling Adaptor (LCA—available at extra cost) can be used to gain 3½" on certain fan models.
- Over pool tables, be sure to provide plenty of clearance to avoid damage from pool cues.
- In kitchens be sure to allow for open cupboard doors to clear the fan blades.
- Do not install a fan close to, or over, a pool or spa. High humidity combined with corrosive gases will destroy the finish and warp the blades.

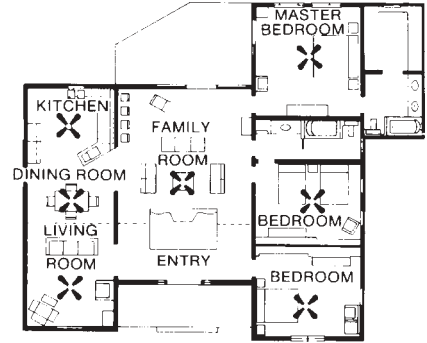

### Fan Size

Variable fan speed capability permits the use of a full-size 52" fan even in smaller rooms. For very large rooms, two fans may be needed.

## SLOPED CEILING INSTALLATIONS

Suggested Extension Pole Lengths	
Ceiling Height	Pole Length
8'	Standard
8' 6"	Standard
9'	6"
9' 6"	12"
10'	12"
11'	18"
12'	24"
13'	36"
14'	48"

### When to Use Extension Poles

For best performance and best appearance, an extension pole should be used with your Casablanca fan when installing on high (cathedral) ceilings or sloped ceilings. Casablanca offers standard poles in increments of 6" up to 5'. Custom poles are available in lengths up to 9' 9". See your Authorized Casablanca Dealer for details.

**NOTE:** Fan may wobble or vibrate if pole length is not long enough and inside blade is too close to downslope or side wall. Extending pole length will usually solve problem.

### Calculation of 32°

Use the tear-off *Ceiling Angle Template* card inserted in the back of this manual, it provides you with a simple 'go' or 'no-go' for installing your fan on a sloped ceiling.

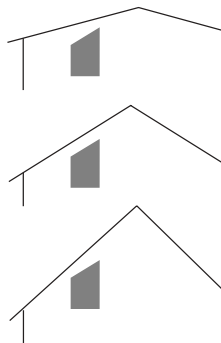
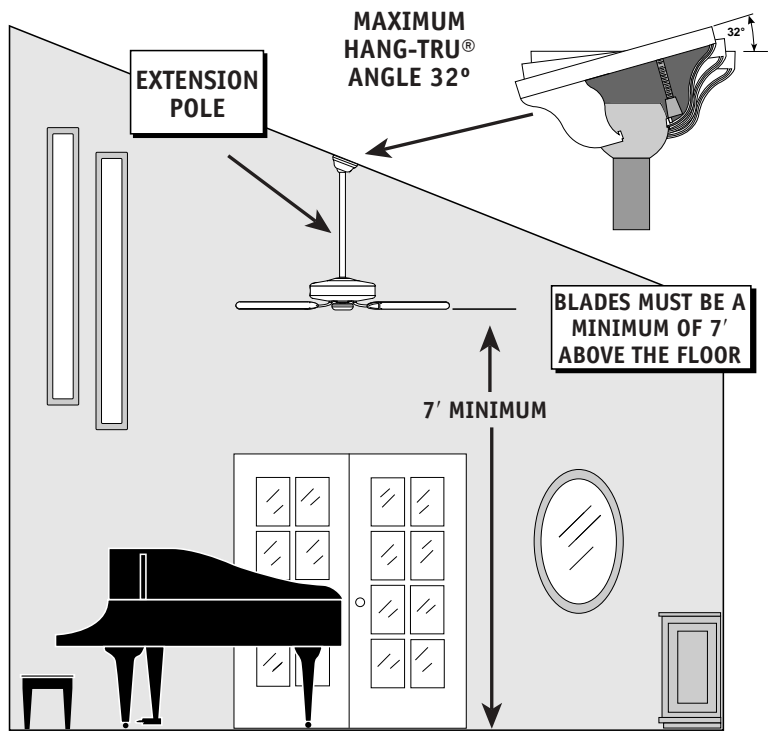

#### EXAMPLE 1

This slope is less than 32°. It is OK to install your fan.

#### EXAMPLE 2

This slope is 32°. This is the maximum slope that will allow the fan to hang straight down. It is OK to install your fan.

#### EXAMPLE 3

This slope is more than 32°. Your fan will not hang straight down, an adaptor is necessary. Contact your local Authorized Casablanca Dealer in regards to purchasing a "Slope Ceiling Adaptor."

## INSTALLATION INSTRUCTIONS

**Unpacking:** Before assembling and installing your ceiling fan, remove all parts from the shipping cartons and check them against the parts listed here. Before discarding packaging material, be certain that all parts have been removed.

**NOTE:** Only one set of blade holders is supplied. Depending on the fan model and series they will be either the *Commodore Style*, the *Center Style*, the *Badge Style* with matching badges, or the *Standard Style* blade holder.

## PERMA•LOCK™ HARDWARE

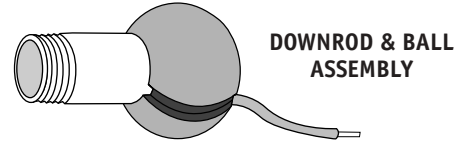

## FAN PREPARATION

**IMPORTANT SAFETY INFORMATION!**  
BEFORE STARTING THE INSTALLATION OF YOUR CEILING FAN, INSTALL THE THREADED DOWNROD INTO THE MOTOR COUPLING AND LOCK THE ASSEMBLY

Prepare for fan installation as follows:

**Step A.** Route the wires from the motor through the Perma•Lock™ downrod and ball assembly.

**Tip:** The downrod has a tapered thread that is designed to lock completely when correctly installed.

**Step B.** Using the provided allen wrench, loosen the set screw several turns to allow installation of the downrod. Thread the downrod into the motor coupling until it stops turning, this will take at least four and a half full turns.

**Step C.** Securely tighten the set screw with the provided allen wrench to ensure safe operation of your fan.

**CAUTION:** Failure to fully lock in the downrod before securely tightening the set screw may cause the fan to separate from the downrod during normal operation!

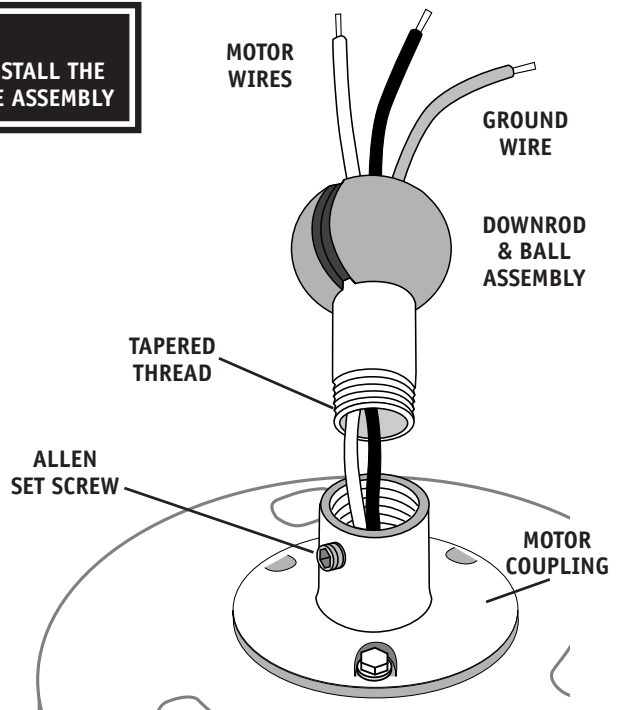

## CEILING HARDWARE

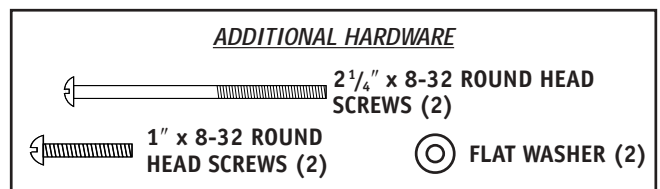
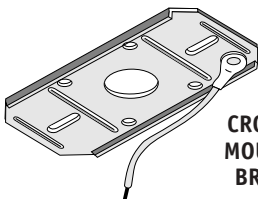

## GETTING STARTED

### Installing a New Ceiling Fixture Outlet Box

If you do not have an existing fixture located where you wish to place your Casablanca fan, an approved ceiling fixture outlet box must be installed and wired.

**Warning:** To reduce the risk of fire, electrical shock, or personal injury, mount to outlet box marked acceptable for ceiling fan support using the mounting hardware provided with the outlet box.

### Using Existing Ceiling Fixture Outlet Box

After turning the power OFF at its source (either circuit breaker or fuse box), lower the old fixture and disconnect the wiring. Check the ceiling fixture outlet box to be sure that it is marked 'Approved for ceiling fan mounting'. If it is not, a new box must be installed.

## CROSSBAR MOUNTING BRACKET INSTALLATION

**NOTE: FOR INSTALLATION OUTSIDE USA (EXCEPT MODELS ENDING IN 'E') USE THE HANGING INSTRUCTIONS ON PAGE 8.**

Proceed with installation as follows:

**Step 1.** Route the wires from the ceiling outlet box through the crossbar mounting bracket center hole. Attach the bracket, with ground wire and ridges down, to the ceiling fixture outlet box with the mounting hardware included with the outlet box.

Tighten the screws firmly by *hand* only, being careful not to bend the bracket by over tightening.

**CAUTION:** To reduce the risk of personal injury, use only the mounting hardware provided with the approved outlet box to install the crossbar mounting bracket.



CEILING FAN APPROVED WIRING BOX

CEILING WIRING

CROSSBAR MOUNTING BRACKET

FLAT WASHER

APPROVED OUTLET BOX HARDWARE

RIDGE SIDE DOWN

GREEN GROUND WIRE

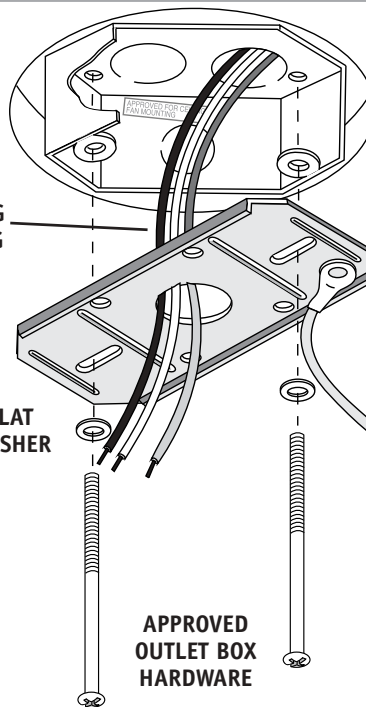

## CANOPY HARDWARE

CANOPY HATCH

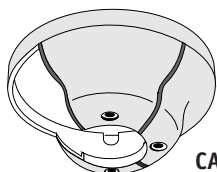

CANOPY

CANOPY SCREW (4)

CANOPY LOCK WASHER (4)

## CANOPY INSTALLATION

**Step 2.** Attach the canopy to the crossbar mounting bracket with three of the 8-32 x 2 1/4" long canopy screws and canopy lock washers. Tighten the screw firmly by *hand* only.

**NOTE:** On sloped ceilings, align the canopy opening towards the top or room peak.

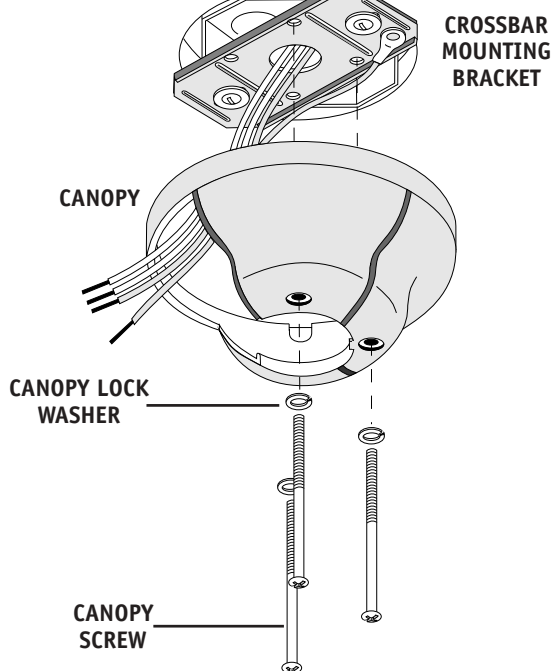

## HANGING THE FAN

**Step 3.** To hang the fan body in the canopy, hold the fan body firmly and insert the ball into the canopy opening. Check that no wires were pinched. Rotate the fan body until the slot in the ball fits into the pin opposite the canopy opening.

**Fan Hanging Weight is 20 lbs**

*Note: Independent control of the light fixture using a W-80 requires an additional independent power wire run from the wall switch to the fan. See Page 7 for wiring.*

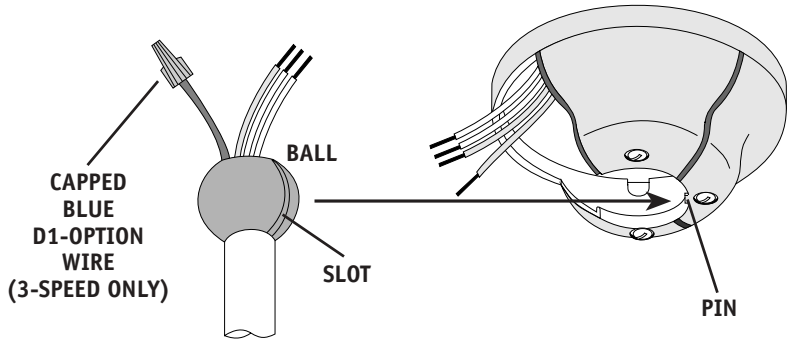

## CANOPY ELECTRICAL CONNECTIONS

**Step 4a.** Attach the fan wires to the ceiling fixture outlet box wiring by placing the bare ends of the wires side by side and then securing with a wire nut. Test that the connection is secure by pulling on the wire nut. Connect in this order:

**Step 4b.**

- GREEN leads from mounting plate and fan to GROUND conductor of power source. Secure with wire nut.
- WHITE wire from fan to white NEUTRAL wire in ceiling fixture outlet box. Secure with wire nut.
- BLUE (3-Speed only) wire and BLACK power wire from fan to BLACK power wire in ceiling outlet box. Secure with wire nut.

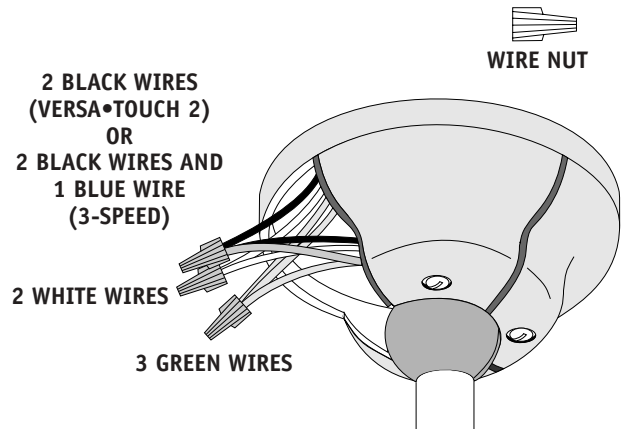

## CANOPY HATCH INSTALLATION

**Step 5.** Tuck the wires into the canopy with the wire nuts pointed upwards, so that the WHITE and BLACK wires are on opposite sides of the canopy and all wires are clear of the canopy opening.

**Step 6.** Install canopy hatch with the last canopy screw and lock washer. To do this, tilt the fan body away from the hatch opening. Using the screwdriver, tighten the screws firmly by *hand* only.

**Step 7.** Straighten the fan, then check to ensure that there is no movement between the canopy and ceiling or Hang-Tru ball and top support shaft.

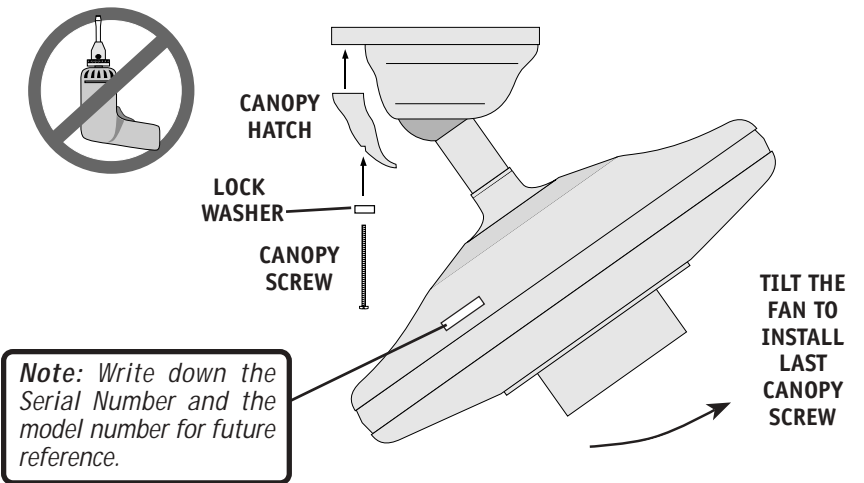

## BLADE & BLADE HOLDER INSTALLATION

**Step 8.** Attach the blades to the blade holders with the three blade screws and flat washers provided for each blade. Hand tighten securely.

Install the assembled blade and blade holder to the fan motor. Hand tighten securely. Repeat for each blade assembly.

Attach the pull chain fob.

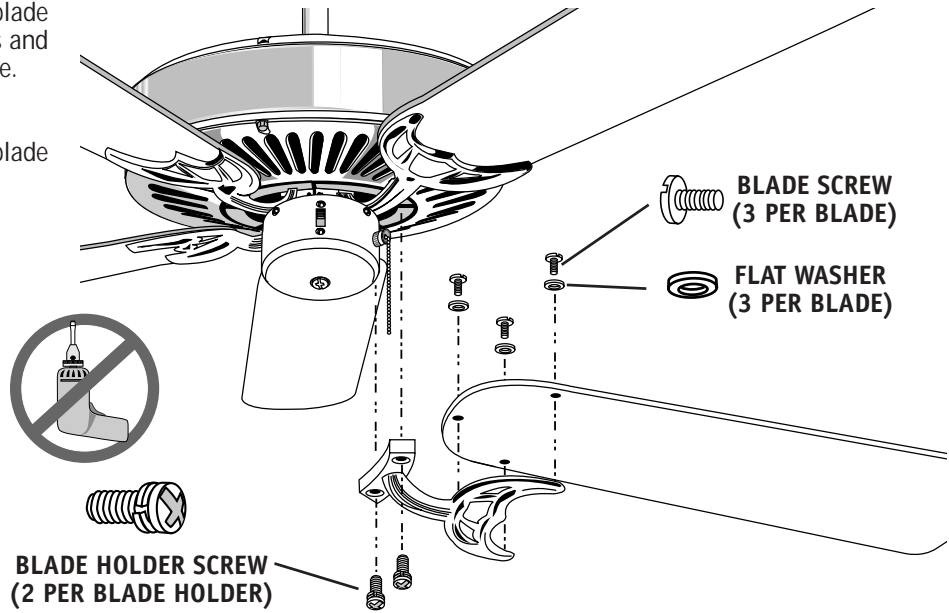



## 3-SPEED ♦ OPERATION

Pull-chain switches on the fan control the fan and lights. Using the fan control pull-chain switch: Fan off at start.

- First pull: fan ON, low speed
- Second pull: medium speed
- Third pull: high speed
- Fourth pull: fan OFF

Using the optional light pull-chain switch: Light off at start.

- First pull: light ON
- Second pull: light OFF

Direction of blade rotation is controlled by the reverse slide switch on the side of the switch housing.

No changes in household wiring are required.

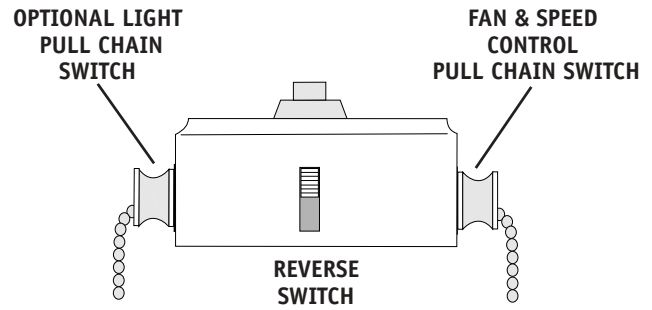

## 3-SPEED ♦ OPTIONAL LIGHT FIXTURE INSTALLATION

**NOTE:** If a separate circuit is used to control the lights from a wall control, the BLUE D1-Option wire in the canopy should be connected to that switch leg with the BLACK fan power wire.

1. Refer to light kit instructions to assemble and attach your light kit correctly.
2. Remove the two 8-32 screws from the switch housing cap.
3. Remove the plug from switch housing.
4. Install pull-chain switch and finger tighten collar on switch.
5. Connect one wire from pull-chain switch to the BLUE D1-Option wire. Secure splice with a wire nut.
6. Connect other wire from pull-chain switch to BLACK wire from light kit. Secure splice with a wire nut.
7. Connect WHITE wire from switch housing to WHITE wire from light kit. Secure splice with a wire nut.
8. At the canopy, connect the BLACK and BLUE wires.

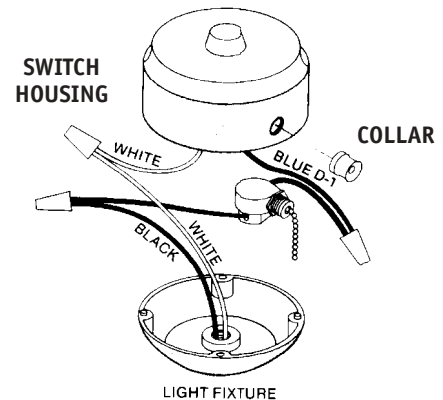

## 3-SPEED ♦ OPTIONAL WALL CONTROL ♦ W-40

The W-40 wall control provides four-speed control of fan from a convenient wall location. The W-40 is designed to replace a standard wall switch and will fit wall boxes with a depth of 2" or greater. **Not for use with single pull-chain fan/light option wiring.**

To install a W-40 wall control in place of an existing wall switch, follow the instructions on the W-40 package.

Note: No rewiring is required if the fan is replacing an existing light fixture.

Operation of the fan from the wall switch is simple:

1. Turn knob to obtain desired speed setting.

**CAUTION! Failure to set the pull-chain speed to HIGH can result in faulty operation of the fan and damage to the W-40 wall control. To confirm fan is set to HIGH: Turn W-40 fan speed switch to 'HI' - set fastest fan speed with pull chain.**

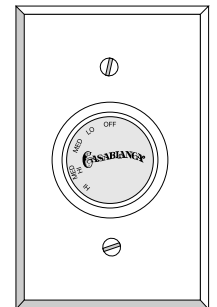

## 3-SPEED ♦ OPTIONAL WALL CONTROL ♦ W-80

The W-80 wall control provides separate control of fan and light with two separate knobs from a convenient wall location. The W-80 is designed to replace a standard wall switch and wall boxes with a depth of 2" or greater. Requires two hot leads from wall box to ceiling wiring box.

To install a W-80 wall control in place of an existing wall switch, follow the instructions on the W-80 package.

Operation of the fan from the wall switch is simple:

1. Turn the upper knob to the desired fan speed.
2. Turn the lower knob to the desired light setting.

**CAUTION! Failure to set the pull-chain speed to HIGH can result in faulty operation of the fan and damage to the W-80 wall control. To confirm fan is set to HIGH: Turn W-80 fan speed switch to 'HI' - set fastest fan speed with pull chain.**

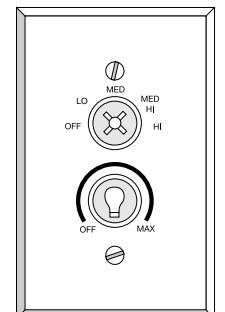

# 3-SPEED

## 3-SPEED ♦ W-40 WALL CONTROL OF THE FAN

- The W-40 allows the choice of four (4) different speed settings.
- No light fixture is used.
- Set the FAN pull chain switch to the HIGH speed setting.
- No changes in household or fan wiring are required.
- The fan may be turned ON and OFF by the W-40 wall control.

**CAUTION!** Failure to set the pull-chain speed to HIGH can result in faulty operation of the fan and damage to the W-40 wall control. To confirm fan is set to HIGH: Turn W-40 fan speed switch to 'HI' - set fastest fan speed with pull chain.

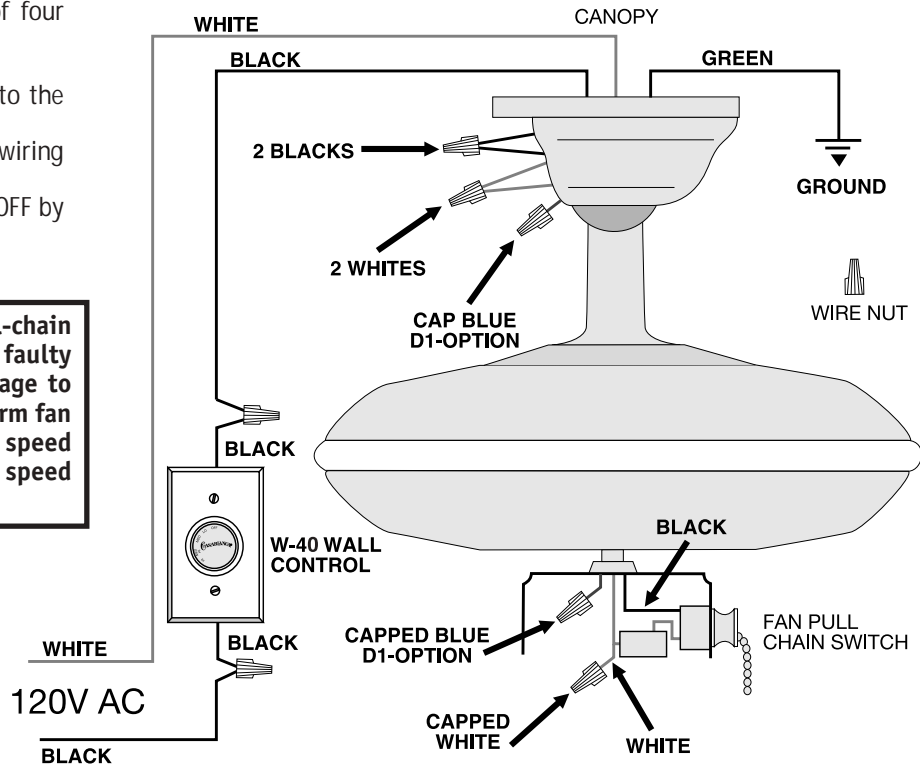

## 3-SPEED ♦ W-80 WALL CONTROL OF THE FAN & LIGHT(S)

- The fan may be turned ON and OFF by the W-80 wall control.
- The lights may be turned ON and OFF by the W-80 and the intensity adjusted from low to high.
- The fan must be supplied with two independent 120V AC supply wires.
- Set the FAN pull chain switch to the HIGH speed setting.
- Turn the lights ON at the fan.
- The W-80 allows the choice of four (4) different speed settings.

**CAUTION!** Failure to set the pull-chain speed to HIGH can result in faulty operation of the fan and damage to the W-80 wall control. To confirm fan is set to HIGH: Turn W-80 fan speed switch to 'HI' - set fastest fan speed with pull chain.

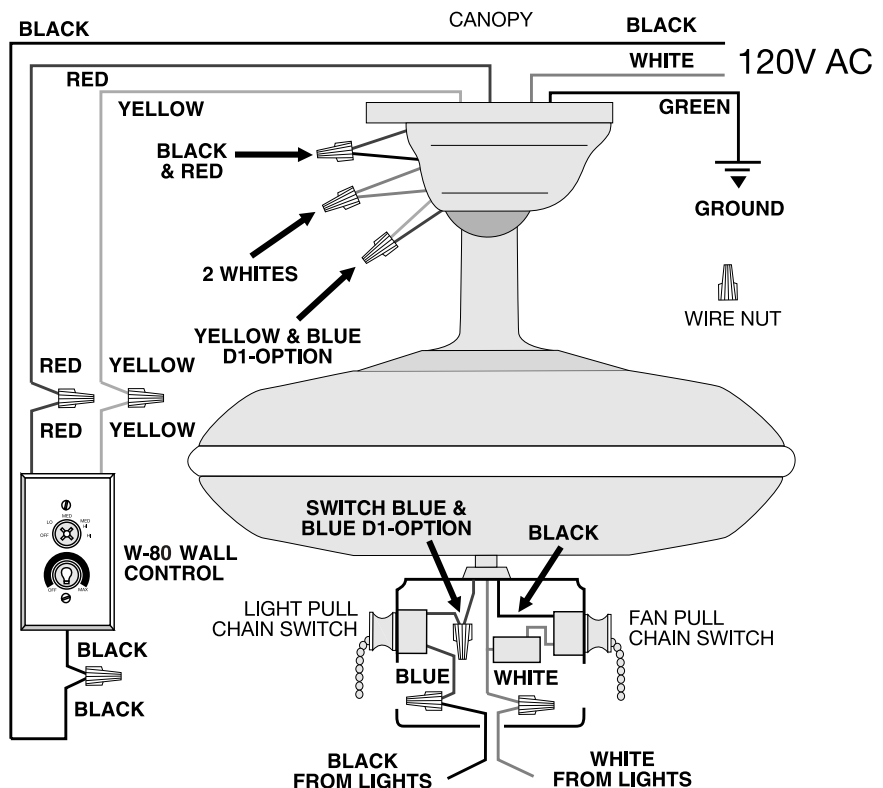



## TROUBLESHOOTING

**Before Requesting Service: Please follow this troubleshooting guide before contacting your dealer for assistance.**

**Caring for Finishes:** For cleaning, a soft brush or lint-free cloth should be used to prevent scratching the finish. A vacuum cleaner brush nozzle can remove heavier dust. Surface smudges or an accumulation of dirt and dust can easily be removed by using a mild detergent and slightly dampened soft cloth. An antistatic agent may be used, but *never* use abrasive cleaning agents. These will damage the finish. Painted and high-gloss blades may be cleaned in the same manner.

**Blades:** Wood finish blades should be cleaned with a furniture polishing cloth. Occasionally, a light coat of furniture polish may be applied for added protection and beauty.

**Never Lubricate this Fan!**

The precision motor at the heart of your Casablanca fan features sealed bearings that are lubricated for life. Do not attempt to oil the motor.

**Changing Light Bulbs**

Be sure to turn power to the fan OFF at the wall switch or circuit breaker before changing light bulbs. Replace bulbs with same type as removed from the fixture. Each fan is rated for a maximum **TOTAL** wattage of lighting.

Exceeding the rated maximum allowable wattage for the fan will burn out the fan electronics module and void the warranty.

PROBLEM	3-SPEED	POSSIBLE REMEDIES
---------	---------	-------------------

**FAN WILL NOT START**

Check main circuit fuses, circuit breakers, or wall switch position.  
Check all wire connections, making sure the power is turned off during this inspection.  
Check that reverse switch is not set in center of throw.

**FAN WOBBLER OR SHAKES EXCESSIVELY**

Be sure canopy pin is properly set into the slot on the ball.  
Check the screws holding the blade holders to the flywheel (or direct drive motor). Tighten as necessary.  
Check that bladeholders have not been bent during installation.

**FAN NOISY DURING OPERATION**

Check and tighten light fixture retaining screws, glass shade screws and/or the light bulb(s) as necessary.  
Tighten the blade to bladeholder screws.  
Tighten canopy screws and mounting plate assembly.

**BREAK-IN PERIOD DOES NOT RUN ON LOW SPEED**

Check and tighten blade holders to flywheel (or direct drive motor).  
Make sure all screws in the motor housing are snug, but not overly tight.  
Check that the wire nuts inside the canopy and switch housing are not touching the metal parts or have fallen off the wire splices. Tighten or adjust as necessary.  
Let fan run at high speed for two (2) hours  
If new, "break-in" may be required - run at higher speed for several days

*FAN RUNS SLOWLY IN EITHER DIRECTION IF ROTATION IS STARTED BY HAND; WILL NOT REVERSE: Defective reverse switch; defective capacitor; or open motor winding: Replace reverse switch assembly; replace PCB assembly; or replace motor unit.*

*FAN WILL NOT OPERATE AT PROPER SPEEDS OR WILL NOT OPERATE AT ANY SPEED: Defective three-speed pull-chain switch assembly; or defective capacitor: Replace three-speed pull-chain switch assembly; or replace PCB assembly.*



### PERFORMANCE AND ENERGY INFORMATION

Fan Speed	Airflow (CFM)*	Power Use (watts)	Airflow Efficiency (CFM/watt)
Low	2716	9	299
Med	3724	31	121
Hi	6640	81	81

\*Measured according to the ENERGY STAR®-approved Solid State test method.

**Ceiling fan airflow is measured in cubic feet per minute (CFM). Power use is measured in watts. To maximize energy savings,**

- Choose a fan with high airflow efficiency (CFM/watt).
- Use ENERGY STAR®-labeled lighting in your fan.
- Remember to switch off your fan when you leave the room.

## PRODUCT SPECIFICATIONS

**Model Name:** Concentra®

**Model Number:** 49xxD

**Dimensions:** A = 11.1"  
B = 12.75"  
C = 3"  
D = 11.5"  
E = 5.6"

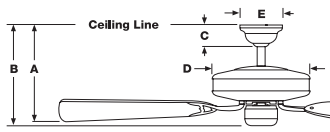

**Weight:** 20 lbs.

**Motor:** 188mm x 20mm Direct Drive™

**Blade Span With:** 50"

**Blade Pitch:** 16°

**No. of Blades:** 5

**Technology:** 3-Speed

**Airflow:** 6,640 cfm

**Electricity Use:** 81 watts

**Airflow Efficiency:** 81 cfm/watt