



# **Electronic/Mechanical Thermostat**

installation and  
operation manual

**Model 40170**



## Table of Contents

Important Information.....	5
Tools .....	6
Uninstalling the Existing Unit .....	9
Installing the Thermostat .....	13
installing the wall plate .....	15
connecting the wires .....	17
attaching the thermostat .....	19
Operation .....	23
Indicators & Adjustments .....	25
Troubleshooting .....	28
Wiring Diagrams .....	30

# Electronic/Mechanical Thermostat

## Model 40170

### **Congratulations!**

Thank you for choosing a Hunter thermostat. Your new Hunter thermostat will provide years of reliable service and year-round energy savings.

Please read this manual before beginning installation and save this booklet for complete operation instructions.

## ***IMPORTANT INFORMATION***

This thermostat is designed to work on the following heating and cooling systems:

Gas – Standing Pilot

Gas – Electronic Ignition

Gas – Fired Boilers

Gas – Millivolt Systems

Oil – Fired Boilers

Oil – Fired Furnace

Electric Furnace

Electric Air Conditioning

Single-stage Heat Pump Systems

This thermostat is not designed for Multi-stage heat pump systems or 110/220 V baseboard heating systems.

If you are unsure what kind of heating and cooling system you have, please contact a qualified HVAC Technician for assistance.

## ***TOOLS***

This thermostat includes two #8 slotted screws and two wall anchors for mounting.

To install your new thermostat, you will need the following supplies:

Flat-head screwdriver

.....

Small Phillips-head screwdriver

.....

Hammer

.....

Electric drill and 3/16" bit

.....

Two fresh 1.5 Volt (AA) size alkaline batteries

.....



**NOTICE! Do not disconnect the wires from the existing thermostat before reading these instructions. The wires must be labeled prior to removal to ensure proper reconnection.**

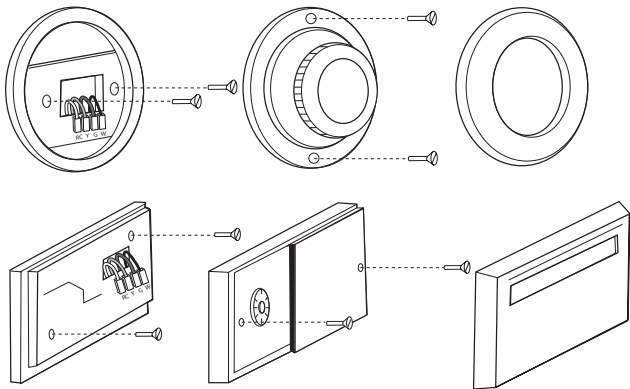



## ***UNINSTALLING THE EXISTING UNIT***

1. Turn the system power OFF from the existing thermostat. Turn the power to the HVAC system OFF at the main power panel or at the furnace.
2. Remove the existing thermostat cover to access the wires from the wall.  
(Some thermostats may have multiple covers, screws or other locking devices that must be removed or disengaged.)
3. Locate, but do not disconnect the wires.  
(If wires are not visible, they may be connected to the back of the wall plate. Some models may have doors that open to expose the wires and mounting screws.)

if your existing  
thermostat is marked...

label the wire  
with this sticker:

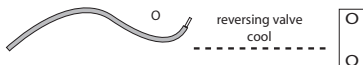
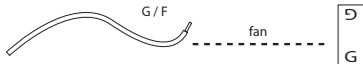
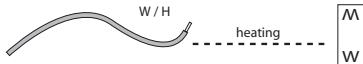
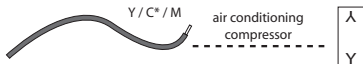

## UNINSTALLING THE EXISTING UNIT, CONT.

- Using the provided stickers, label each wire according to the chart.

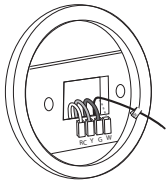

(If the terminals are not labeled, contact a qualified HVAC technician.)

***Note: Wire colors do not always comply with standards, so wire color should be ignored. Refer to the existing terminal designation for proper identification.***

\*If wires marked Y & C are both present, C may be a Common wire and should not be used. If you have a wire marked C, do not connect it to any terminal. This wire is used only for non-battery powered thermostats.

- Do not let the wires slip back into the wall during disconnection. You may want to secure the wires to the wall as you disconnect them. After all wires are labeled, disconnect each wire and remove the existing wall plate.

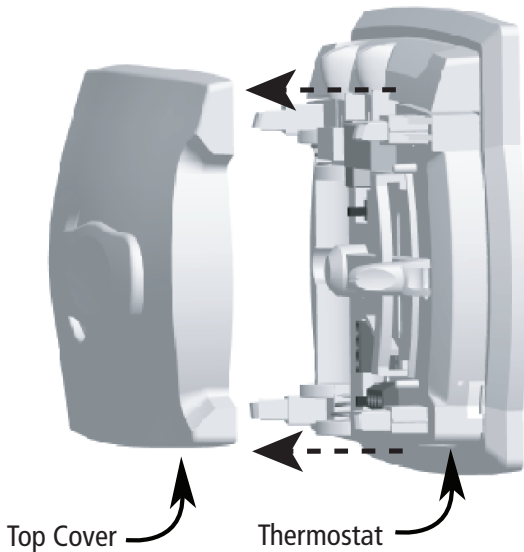

1. Remove the top cover from the new thermostat by pulling the two halves apart.

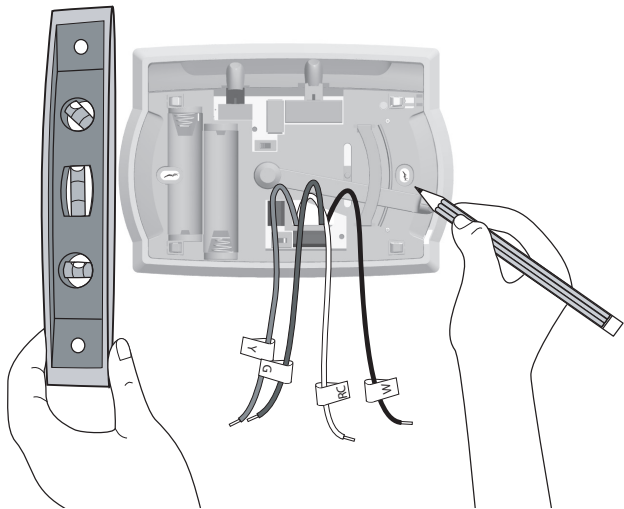

### **INSTALLING THE WALL PLATE**

2. Position the new thermostat on the wall and pull the labeled wires through the opening.
3. If the existing holes do not match those on the Hunter wall plate, or if there are no existing holes, level the thermostat and mark the wall for two holes.
4. Remove the thermostat and drill two 3/16" holes where marked.
5. Tap the plastic anchors into the holes until they are flush with the wall.
6. Reposition the thermostat on the wall, pulling the wires through the opening. Insert the mounting screws through the mounting holes and into the anchors. Verify that the thermostat is visually level and securely tighten both screws.

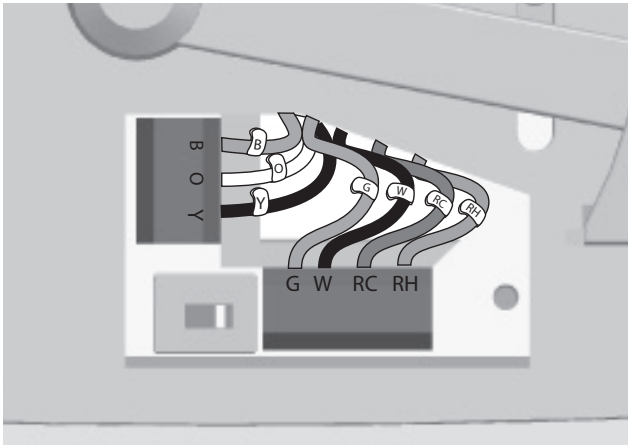



## CONNECTING THE WIRES

1. Loosen, but do not remove, the terminal screws.

*Note: A jumper wire has been provided, connecting the RC and RH terminals for systems that do not provide both an RH and RC wire. If you have both an RH and RC wire, remove this jumper. If you do not have both an RH and RC wire, leave the jumper in place.*

2. Match and connect the wires from the wall to the terminals as shown. Wires should be inserted behind the black terminal shields. Tighten each screw after the connection has been made.  
(The ends of any extra wires should be wrapped in electrical tape and carefully pushed back into the wall.)
3. Push any excess wire length back into the wall to prevent interference.

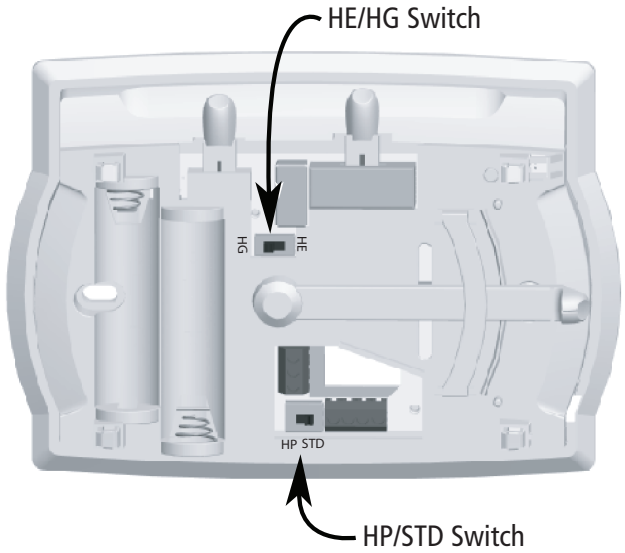

HE/HG Switch

HG HE

HP STD

HP/STD Switch

**ATTACHING THE THERMOSTAT**

1. Locate the **HE/HG SWITCH** on the wall plate. Set the switch to **HG** for a gas furnace or oil burner. Set the switch to **HE** for electric furnaces.

(The switch has no effect when the system is set to cooling mode.)

2. Locate the **HP/STD SWITCH** on the wall plate. Set the switch to **HP** for Single-stage heat pump systems. Set the switch to **STD** for conventional systems.

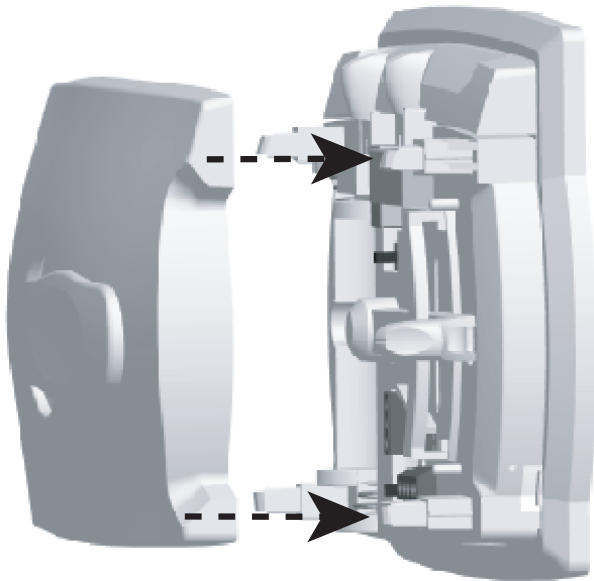

## ***INSTALLING THE THERMOSTAT, CONT.***

3. Insert two fresh AA alkaline batteries.
4. Align the top cover with the the wall plate, and snap the two halves together.
5. Restore power at the electrical panel or furnace.

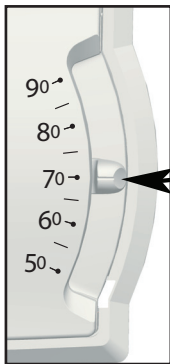

Set Temperature  
Slider

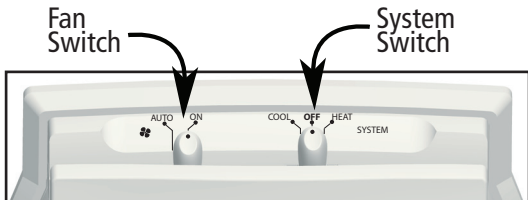

## OPERATION

1. Set the **SET TEMPERATURE SLIDER** to the desired temperature.
2. The **SYSTEM SWITCH** determines the operating mode of the thermostat. Select **COOL**, **OFF**, or **HEAT**.
3. The **FAN SWITCH** should normally be located in the **AUTO** position. To run the fan continuously, slide the **FAN SWITCH** to the **ON** position.

*Note: In **AUTO** , The fan will be turned on along with normal operation of your system. In a normal gas or oil furnace, the fan will be turned on by your furnace after its warm-up delay.*

Thermometer

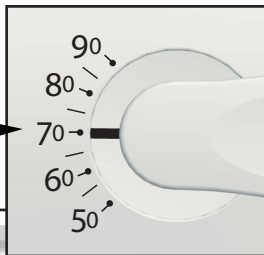

Battery Indicator



## INDICATORS AND ADJUSTMENT

1. The *THERMOMETER* indicates the room temperature.
2. The *BATTERY INDICATOR* displays two battery conditions. The first warning is the *WEAK BATTERY WARNING*, indicated by the *BATTERY INDICATOR* flashing once approximately every three seconds. When this warning appears, install two fresh AA alkaline batteries at your earliest convenience.
3. The second warning is the *SHUT-DOWN INDICATOR*, indicated by the *BATTERY INDICATOR* flashing approximately twice every second. When this warning appears, the thermostat is shut down and will turn your system OFF. Your system will remain shut-off until you install two fresh AA alkaline batteries.

Span Adjust

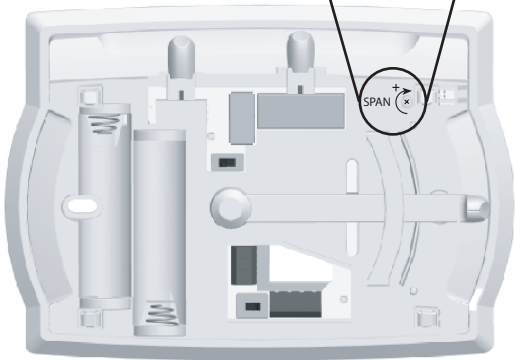
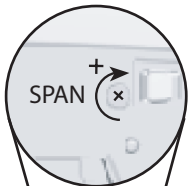

Your thermostat is preset to cycle your system off and on at 1°F above and below the Set Temperature. For maximum system efficiency and a sustained comfortable temperature your system should cycle 3 - 5 times per hour. If your system is cycling either too often or not often enough, then use a small Phillips-head screwdriver and the **SPAN ADJUST** to change the cycle time.

1. Remove the top cover from the thermostat.
2. To make your system run LONGER, turn the **SPAN ADJUST** clockwise.
3. To make your system run SHORTER, turn the **SPAN ADJUST** counter clockwise.
4. Reattach the top cover to the thermostat.

*Note: The Span range is 0.6°F - 3°F. The Span setting remains the same in both the Heat and Cool modes and can be changed regardless of what position the System Switch is in.*

## 1. My heating or cooling will not turn on or off.

- 1 a. Check the HE/HG switch to ensure it is set to the correct position.
- 1 b. Wait. There may be as much as a 4-minute delay before the system turns on or off to protect the compressor.
- 1 c. Check the circuit breakers and switches to ensure there is enough power to the system.
- 1 d. Replace the batteries with fresh AA alkaline batteries.
- 1 e. If applicable, make sure the furnace blower door is closed properly.
- 1 f. If your system has 4 wires, ensure the jumper wire is installed between the RC and RH terminals.

---

## 2. My system continues to operate when the thermostat is in the off position.

- 2 a. Replace unit.

Is there help on the web?

Yes. Visit <http://www.hunterfan.com> for more information.

.....

Can't I just call someone?

Sure. Our Technical Support Group is available from 8 am to 5 pm CST. They may be reached toll-free at 1-888-830-1326.

4-wire Heat/Cool System

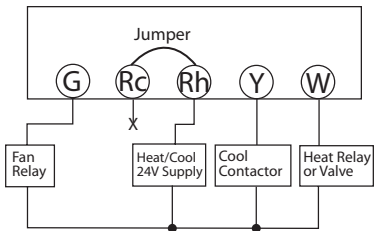

5-wire Heat/Cool System

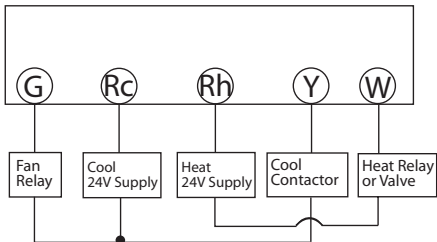

# WIRING DIAGRAMS

## Single-stage Heat Pump System

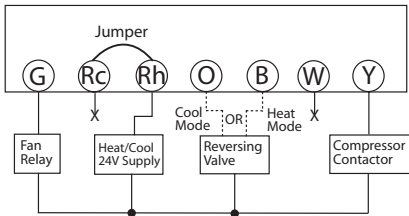

## 2-wire Heat Only System

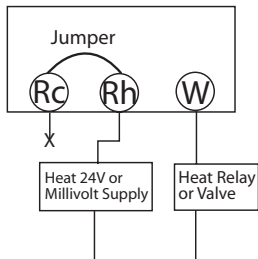

## 3-wire Heat Only System

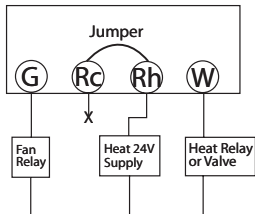

## 3-wire Cool Only System

