

MODEL NUMBER:

- R800 Deck-Mount Tub Filler**
 Rough valve only. 1/2" sweat inlets.
 For use with Colony Soft, Princeton, Tropic, Dazzle and Hampton Tub Spouts.
- R810 Deck-Mount Tub Filler**
 10" Fixed Copper to Copper.

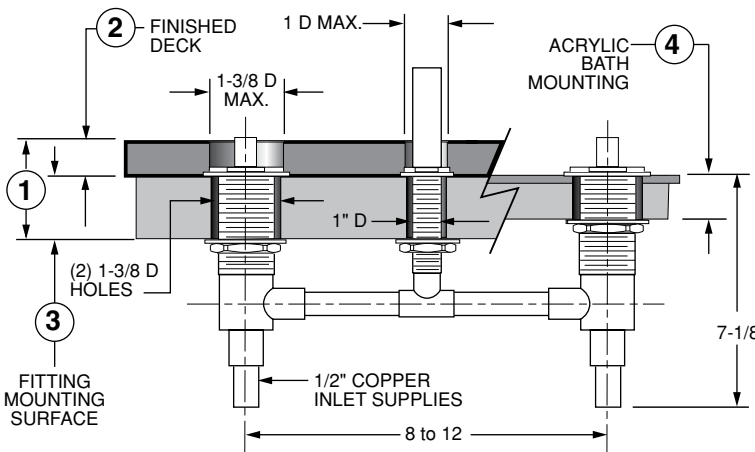

1. DECK THICKNESS

TOTAL DECK THICKNESS UP TO 2-1/2"

2. FINISHED DECK

FINISHED DECK VARIABILITY ACCOMMODATES DECKING MATERIAL (TILE, MARBLE, CORIAN@...) TO 1" THICK

3. FITTING MOUNTING SURFACE

ADJUSTABILITY, TO 1-1/2" THICK

4. ACRYLIC BATHS

ADJUSTABILITY, TO 1-1/2" THICK

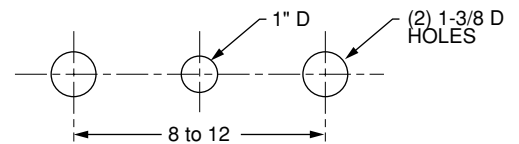

DECK MOUNTING HOLES

GENERAL DESCRIPTION:

R800 features separate brass and 1/2" copper waterway below deck provided for adjustable installations, R810 features a 10" fixed copper to copper. Washerless 1/4 turn ceramic disc valve cartridges. Total rough-in up to 2-1/2". Rough valve body provides 1-1/2" for rough deck installation. Trim kits provide an additional 1" adjustability for finished deck. Valve body will accept a variety of decorative spouts and handles.

CODES AND STANDARDS

These products meet or exceed the following codes and standards:

ASME A112.18.1
CSA B 125

PRODUCT FEATURES:

Brass Construction: Durable. Ideal for prolonged contact with water.

Ceramic Disc Valve Cartridges: Assures a lifetime of drip-free performance.



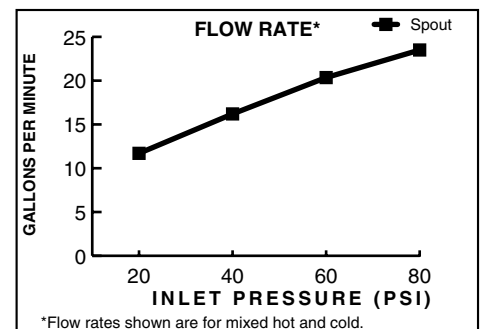



Many Trim Options: Wide range of handle & spout styles.

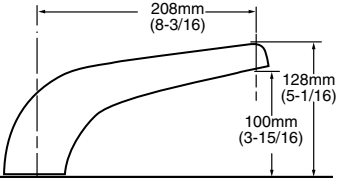

SUGGESTED SPECIFICATION:

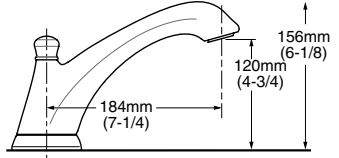
Two handle deck-mount tub filler shall feature cast brass construction with brass and copper waterway. Shall also feature 1/4 turn washerless ceramic disc valve cartridges that are reversible for use with round or lever handles. Fitting shall be American Standard Model # _____ and trim kit # _____.

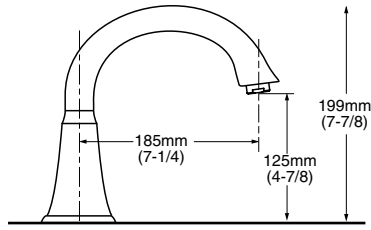
TRIM KITS FOR R800 Rough Valve Bodies

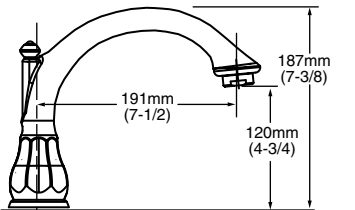
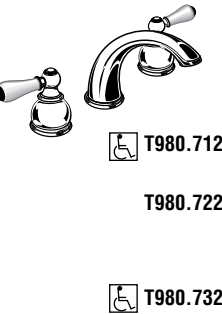
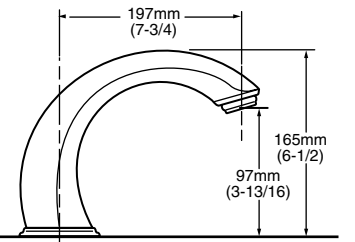
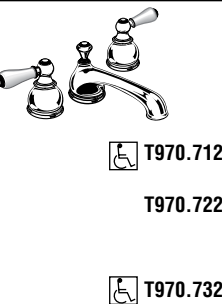
Trim Kit	Model No. Description	Finishes	Roughing-In Dimensions
 <p>T975.500</p>	<p>COLONY SOFT TRIM KIT</p> <ul style="list-style-type: none"> • Cast Brass slip-fit spout • Lever Handles • LESS Valve 	<p>.002 Polished Chrome .295 Satin Nickel (PVD)</p>	
 <p>T508.900</p>	<p>PRINCETON TRIM KIT</p> <ul style="list-style-type: none"> • Cast Brass slip-fit spout • Metal Lever Handles • LESS Valve 	<p>.002 Polished Chrome .068 Blackened Bronze (PVD) .295 Satin Nickel (PVD)</p>	
 <p>T038.900</p>	<p>TROPIC TRIM KIT</p> <ul style="list-style-type: none"> • Cast Brass slip-fit spout • Metal Lever Handles • LESS Valve 	<p>.002 Polished Chrome .295 Satin Nickel (PVD)</p>	
 <p>T028.900</p>	<p>DAZZLE TRIM KIT</p> <ul style="list-style-type: none"> • Cast brass slip-fit spout • Metal Lever Handles • LESS Valve 	<p>.002 Polished Chrome .068 Blackened Bronze (PVD) .295 Satin Nickel (PVD)</p>	
 <p>T980.712 T980.722 T980.732</p>	<p>HAMPTON TRIM KIT</p> <ul style="list-style-type: none"> • Brass Crescent slip-fit spout • LESS Valve • Porcelain Lever Handles • Metal Cross Handles • Metal Lever Handles 	<p>.002 Polished Chrome .099 Polished Brass (PVD) .295 Satin Nickel (PVD)</p> <p>.002 Polished Chrome .068 Blackened Bronze (PVD) .099 Polished Brass (PVD) .221 Satin (PVD)/Chrome Mix .295 Satin Nickel (PVD) .297 Satin/Brass Mix (PVD) .299 Pol. Chrome/Brass (PVD) Mix</p>	
 <p>T970.712 T970.722 T970.732</p>	<p>HAMPTON TRIM KIT</p> <ul style="list-style-type: none"> • Cast brass slip-fit spout • LESS Valve • Porcelain Lever Handles • Metal Cross Handles • Metal Lever Handles 	<p>.002 Polished Chrome .099 Polished Brass (PVD) .295 Satin Nickel (PVD)</p> <p>.002 Polished Chrome .068 Blackened Bronze (PVD) .099 Polished Brass (PVD) .221 Satin (PVD)/Chrome Mix .295 Satin Nickel (PVD) .297 Satin/Brass Mix (PVD) .299 Pol. Chrome/Brass (PVD) Mix</p>	