

Systems for Floor-Mount, Back Outlet Washdown Toilet

Replacement Parts for Geberit Sigma Concealed Tank (UP320) 109.304.00.5

Item No.	Model No.	Description	List Price
1	240.923.00.1	Fixation clip for filling valve	\$6.00
2	241.469.00.1	Filling valve Type 380* for Sigma and Kappa concealed tanks	24.00
2.1	240.771.00.1	Seal kit for filling valve Type 380*	11.00
3	241.858.00.1	Dual-flush valve complete with valve seat basket	12.00
4	240.622.00.1	Dual-flush valve for Sigma concealed tank	12.00
4.1	241.167.00.1	Yoke set for flush valves	9.00
4.2	816.418.00.1	Flat gasket for flush valve	2.00
5	241.859.00.1	Valve seat basket and noise bushing for flush valve	9.00
5.1	241.868.00.1	U-cup seal for valve basket	2.00
6	241.826.00.1	Mud guard protection housing for Sigma concealed tanks 2x6 (UP320) and 2x4 (UP720), Plastic	11.00
7	242.315.00.1	Splash guard protection cover for UP320	6.00
8	241.829.00.1	Flush actuator gear box	6.00

Item No.	Model No.	Description	List Price
9	362.771.00.1	Seal for concealed flush pipe, EPDM	\$2.00
10	362.796.92.1	Protection plug, Plastic	5.00
11	240.921.00.1	Connection hose for Sigma concealed tank, 3/8"	14.00
	241.854.00.1	Connection hose for Sigma concealed tank, 3/8" – dezincification resistant	21.00
11.1	240.922.00.1	Seal kit for braided hose, EPDM O-Ring	9.00
12	240.853.00.1	Supply angle Stop (black handle)	14.00
12.1	240.851.00.1	Drop Ear Elbow, Copper	11.00
13	152.404.46.1	Connector set with mounting hardware (bowl installation kit), HDPE; Matte Chrome cover caps	38.00
13.1	217.713.46.1	Cover caps with leveling washer, Plastic, Matte Chrome	6.00
13.2	119.668.00.1	Seal for supply inlet tube, EPDM	2.00
13.3	152.424.00.1	Seal for toilet outlet connector, EPDM	3.00

* Formerly called Impuls380 and Impuls360

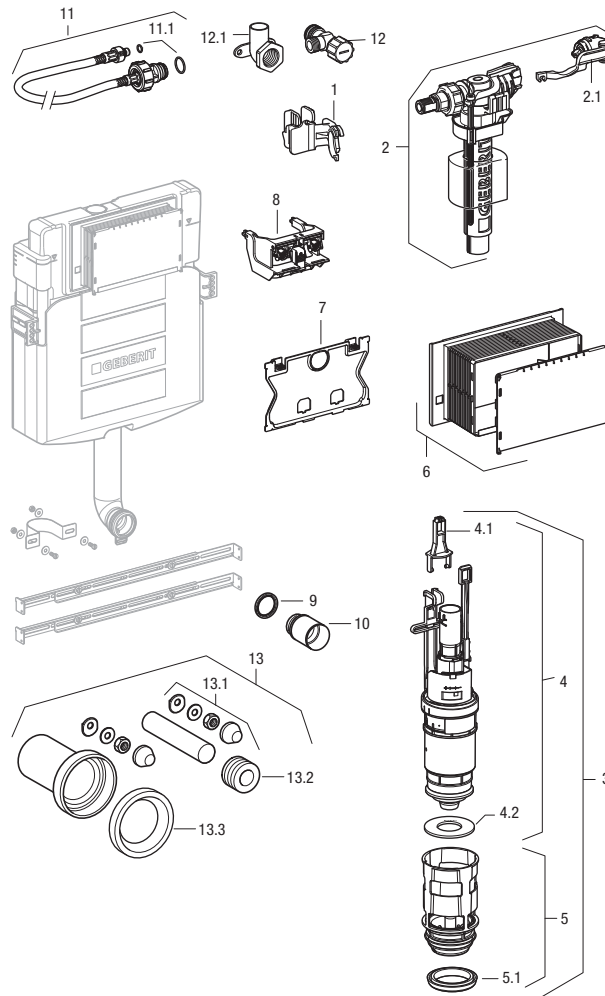

Geberit Flushing System

Replacement Parts for Geberit Sigma Concealed Tank (UP320) 109.304.00.5



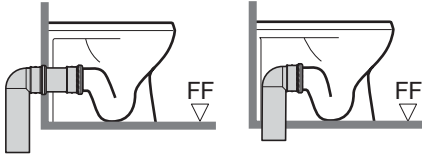



Waste Fitting Discharge Configurations



A. Floor-Mount Rear Discharge into Wall

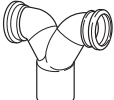

B. Floor-Mount Rear Discharge into Floor

Waste Fittings (Note: Mounting collar/clamp by installer)



Description	Model No.	List Price
 (For A discharge) HDPE waste fitting outlet bend, 1 x 90° bend with socket for 03.50" (Ø90 mm) push fit piping and 03.50" (Ø90 mm) outlet	366.061.16.1	\$19.00
 (For A discharge) HDPE connector with offset for LH horizontal drain connections (as viewed from sitting position), 1 x 90° bend with socket for 03.50" (Ø90 mm) push fit piping, with 45° offset and 03.50" (Ø90 mm) outlet for 5.5" (13.97 cm) minimum walls only.	366.913.16.1	67.00
 (For A discharge) HDPE connector with offset for RH horizontal drain connections (as viewed from sitting position), 1 x 90° bend with socket for 03.50" (Ø90 mm) push fit piping, with 45° offset and 03.50" (Ø90 mm) outlet for 5.5" (13.97 cm) minimum walls only.	366.914.16.1	67.00
 (For A discharge) Cast iron outlet bend; 1 x 90° bend with socket for 03.50" (Ø90 mm) push fit piping and 3" CIP outlet	367.071.18.1	138.00
 (For A discharge) HDPE "Back-to-back" connector for horizontal drain connections; 2 x 90° bends with sockets for 03.50" (Ø90 mm) push fit piping, with 45° offset and expansion to 04.375" (Ø110 mm) outlet for 10.75" (27.31 cm) minimum walls only.	367.485.16.1	138.00
 (For A discharge) HDPE "Back-to-back" connector for vertical drain connections; 2 x 90° bends with sockets for 03.50" (Ø90 mm) push fit piping and expansion to 04.375" (Ø110 mm) outlet for 10.75" (27.31 cm) minimum walls only.	367.923.16.1	138.00
 (For A or B discharge) PP connector set with bend for Floor-Mount toilets with mounting hardware, 1 x 90° bends with socket for 04.375" (Ø110 mm) push fit piping for 03.82"–4.21" (Ø97–107 mm) male connection and expansion to 04.375" (Ø110 mm) outlet	152.647.00.1	103.00

* Mounting collar/clamp by installer

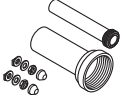
Required Accessories for 3.50"–7.00" (9–18 cm) Finished Wall Thickness

Description	Model No.	List Price
 Mud guard protection housing for Sigma concealed tanks 2x6 (UP320) and 2x4 (JP720), Plastic	241.826.00.1	\$11.00
 Extension set for actuator plates for Sigma concealed tanks 2x6 (UP300, UP320) and 2x4 (JP720) and Kappa concealed tank (UP200)	240.938.00.1	19.00
 HDPE Connector set for extended installation and mounting hardware (bowl installation kit), with socket for 03.50" (Ø90 mm) push fit piping and 02.16" (Ø55 mm) supply inlet; Matte Chrome cover caps	152.438.46.1	50.00

Actuator Accessories

 Cover plate for Sigma concealed tanks 2x6 (UP300, UP320) and 2x4 (JP720), Zinc die cast, Alpine White	115.765.11.1	221.00
 Cover plate for Sigma concealed tanks 2x6 (UP300, UP320) and 2x4 (JP720), Zinc die cast, Matte Chrome	115.765.46.1	221.00
 Cover plate for Sigma concealed tanks 2x6 (UP300, UP320) and 2x4 (JP720), Stainless Steel, Brushed SS	115.798.00.1	175.00

Actuator Accessories for AC Hands Free Device

 NEW Transformer for Mambo AC powered hands free actuator.	115.861.00.1	100.00
---	--------------	--------