

## COMMANDER®

**SC-1210-AF**



**SC-1220-AF**



## Exposed Showers

### GENERAL SPECIFICATION

Commander exposed shower on 6" centers. 1/4 turn ceramic cartridges covered by 25-year warranty. Chrome plated patented vandal-resistant four arm handles with color-coded indexes. Reversible valve body. S-2272-E2 showerhead with flow control device reduces flow to 2.5 gpm/9.46 lpm maximum to meet existing ASME A112.18.1/CSA B125.1 standard.

#### **SC-1210-AF**

Commander exposed chrome plated shower. 1/2" NPTM chrome plated brass risers. Polished chrome plated brass gooseneck with supporting strap.

#### **SC-1220-AF**

Commander exposed rough chrome plated shower. Galvanized gooseneck with supporting strap.

### OPTIONS

SUFFIX	DESCRIPTION
<input type="checkbox"/> LH	Less showerhead
<input type="checkbox"/> LSP	Less supply pipe (SC-1210-AF only)
<input type="checkbox"/> 1	S-2251 showerhead
<input type="checkbox"/> 2	S-2252 showerhead
<input type="checkbox"/> 2VR	S-2252 vandal-resistant showerhead
<input type="checkbox"/> 3	S-2253 showerhead
<input type="checkbox"/> 6	S-2288 showerhead
<input type="checkbox"/> 9	S-2292 showerhead



This space for Architect/Engineer approval.



## ROUGH-INS

### SC-1210-AF

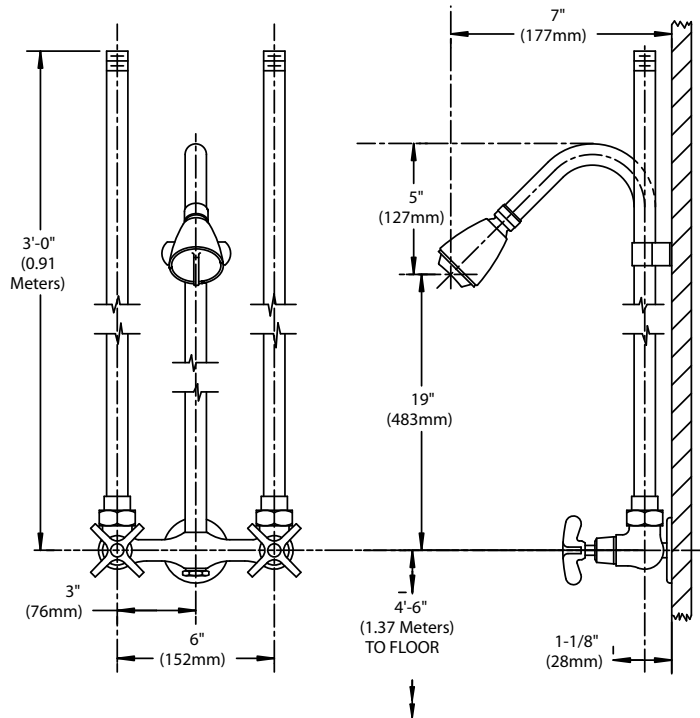

NOTE: Unless otherwise specified, all inlets are 1/2" NPTM. Unless otherwise specified, all dimensions are in inches and are subject to change without notice.

### SC-1220-AF

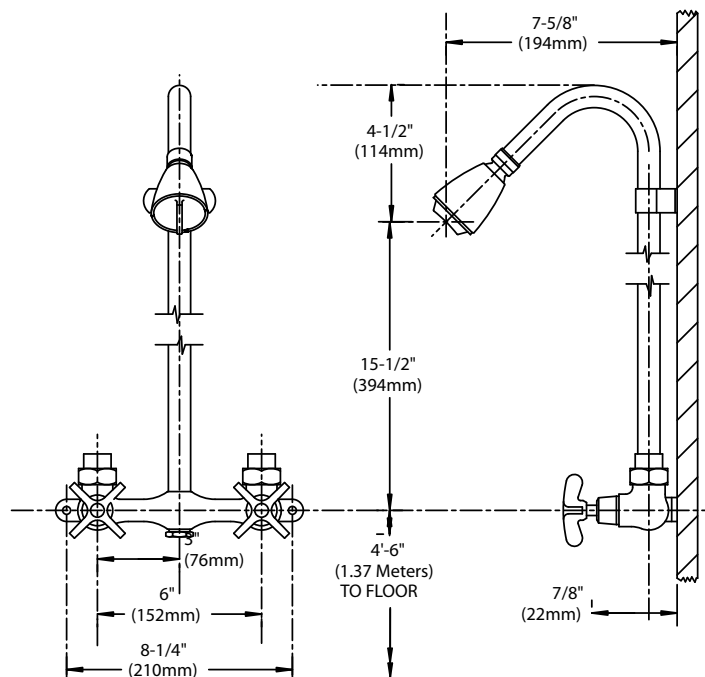

NOTE: Unless otherwise specified, all inlets are 1/2" NPTF. Unless otherwise specified, all dimensions are in inches and are subject to change without notice.