

Features

- Metal construction
- Brass valve bodies
- High-temperature limit setting for added safety
- Rite-Temp® pressure-balancing diaphragm design valve
- Mixing valve cycles from "cold" to "hot"
- Intended for use with Rite-Temp® or HiFlow Rite-Temp® valves
- Pressure-balancing mechanism of one-piece diaphragm cartridge design for ease of maintenance
- ADA compliant lever handle
- Heavy duty slip-fit clamp design

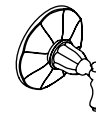
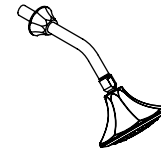

Codes/Standards Applicable

Specified model meets or exceeds the following:

- ADA
- ASME A112.18.1/CSA B125.1
- ICC/ANSI A117.1
- ASSE 1016

Colors/Finishes

- CP: Polished Chrome
- Other: Refer to Price Book for additional colors/finishes

Accessories

- NA: None applicable

Specified Model

Model	Description	Colors/Finishes	
K-T13492-4	Bath and shower valve trim with 1/2" IPS threaded or slip fit diverter spout	<input type="checkbox"/> CP	<input type="checkbox"/> Other ____
K-T13493-4	Shower valve trim, less diverter spout	<input type="checkbox"/> CP	<input type="checkbox"/> Other ____

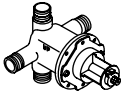
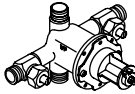
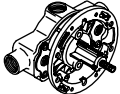
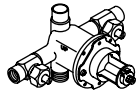
Required Accessories					
K-304-K	Rite-Temp without stops, NPT connections OR	<input type="checkbox"/> NA			
K-304-KS	Rite-Temp with stops, NPT connections OR		<input type="checkbox"/> NA		
K-306-KS	HiFlow Rite-Temp with stops, NPT connections OR			<input type="checkbox"/> NA	
K-304-KP	Rite-Temp with stops, CPVC connections				<input type="checkbox"/> NA

Product Specification

The valve trim shall be made of metal construction with brass valve bodies. Product shall have a Rite-Temp pressure-balancing diaphragm design valve and pressure-balancing mechanism of one-piece diaphragm cartridge design for ease of maintenance. Product shall feature mixing valve cycles from "cold" to "hot," a high-temperature limit stop for added safety and a single ADA compliant lever handle. Product shall feature heavy duty slip-fit clamp design. Product is intended for use with Rite-Temp or HiFlow Rite-Temp valves. Valve trim shall be Kohler Model K-T____-____-____ and required Rite-Temp valve shall be K-____-____-NA.

KELSTON™ RITE-TEMP®

Optional Accessories

1073881 HiFlow Rite-Temp thick wall installation kit

NA

Installation Notes

Install the valve trim according to the installation guide.

Install the Rite-Temp valve according to the installation guide.

Avoid cross-flow conditions. Do not install a shut-off device on either valve outlet.

Cap the shower outlet if the deck-mounted spout, diverter, or handshower is connected to the spout outlet.

Install a 7" (17.8 cm) to 18" (45.7 cm) straight pipe or straight tube with single bath elbow between the valve and the wall-mount spout.

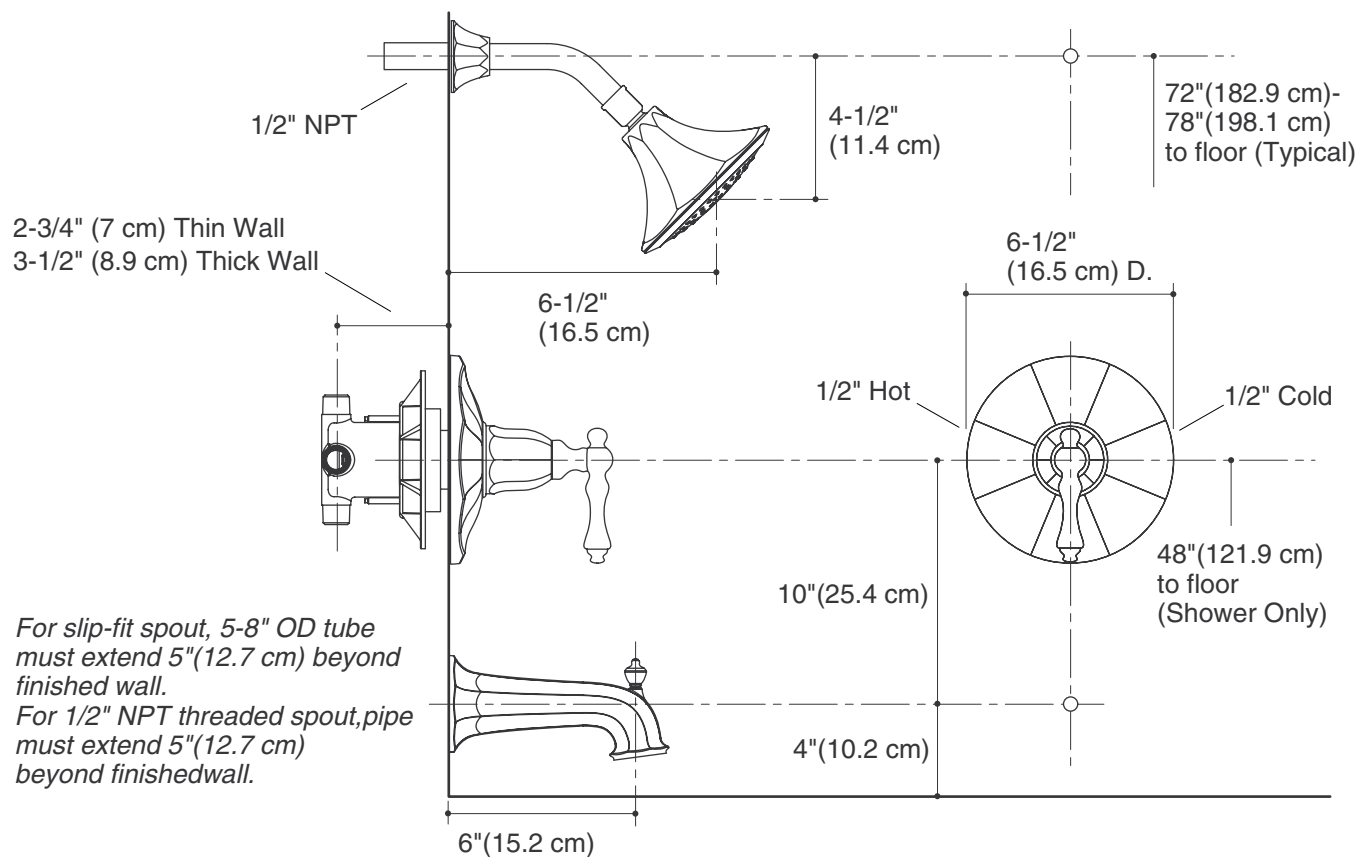

Product Diagram

KELSTON™ RITE-TEMP® BATH AND SHOWER VALVE TRIM

Page 2 of 2
1105000-4-B

THE BOLD LOOK
OF **KOHLER**®