



### Features

- Integral flange.
- Recessed left drain.
- Trough drain with removable drain cover.
- Low threshold shower base.
- One-piece construction.
- Compliments traditional and contemporary bathroom designs.
- Coordinates with Choreograph™ walls.

### Material

- Acrylic

### Installation

- Alcove

### Required Accessories

K- 9330 Drain Cover

or

K- 9334 Drain Cover

### Recommended Accessories

K- 9132 Shower Drain



### Codes/Standards

CSA B45.5/IAPMO Z124

ASTM E162

ASTM E662







Greenguard UL 2818 - Gold

### KOHLER® One-Year Limited Warranty

See website for detailed warranty information.

### Available Color/Finishes

*Color tiles intended for reference only.*

Color	Code	Description
	0	White
	96	Biscuit
	47	Almond
	NY	Dune
	95	Ice™ Grey
	G9	Sandbar

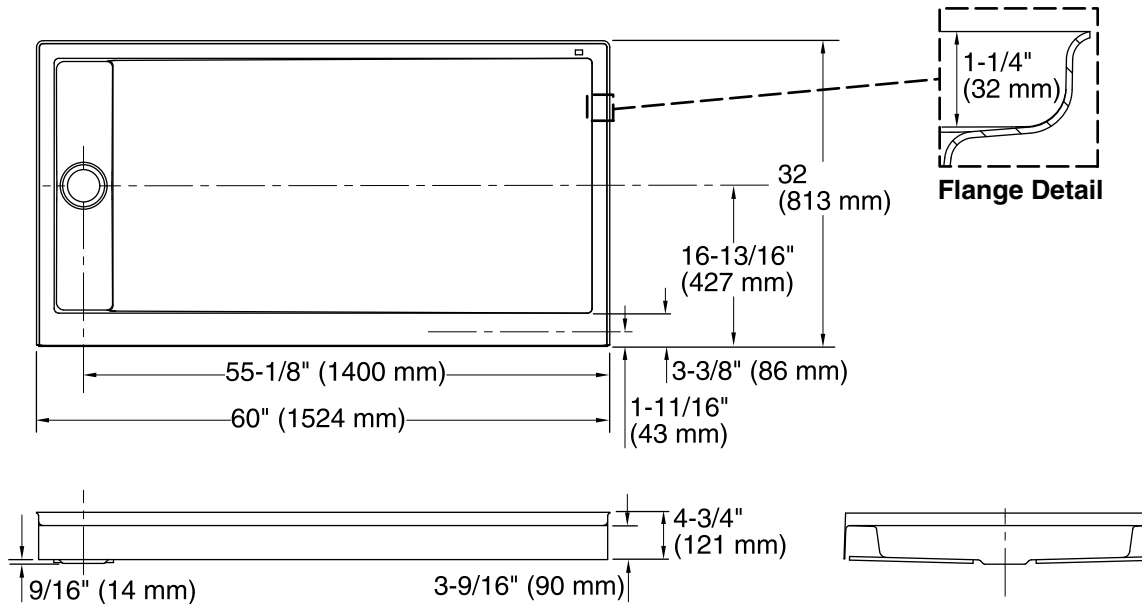

### Technical Information

All product dimensions are nominal.  
 Installation: 3-Wall Alcove  
 Drain location: Left  
 Drain hole diameter: 3-3/8" (86 mm)  
 Weight: 65 lbs (29.5 kg)  
 Minimum floor load: 20 lbs/ft<sup>2</sup> (97.6 kg/m<sup>2</sup>)

### Notes

Measure your actual product for rough-in details. Install this product according to the installation instructions.  
 Measure your actual product for roughing-in details. Install this product according to the installation guide.  
 Shimming may be required to level the fixture. Shimming may be required between the stud frame and the fixture.  
 The stud opening tolerance is +1/4" (6 mm), -0" (0 mm).