

**BATH AND SHOWER FAUCET TRIM  
K-T7004**

**ALSO K-T7226, K-T7744, K-302-K**

**FEATURES**

- Brass construction
- For 8" centers
- Variety of handle style options

**CODES/STANDARDS APPLICABLE**

Specified model meets or exceeds the following:



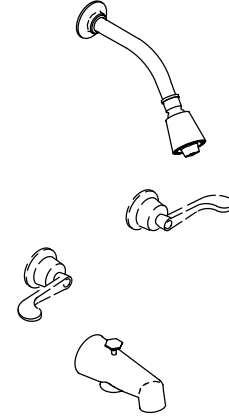

- ASME/ANSI A112.18.1M
- CSA B125
- IAPMO/UPC



**COLORS/FINISHES**

- CP Polished Chrome

**SPECIFIED MODEL:** For complete faucet, both faucet trim and valve system must be specified.

Model	Description		 ADA	 ADA	 ADA
K-T7004-2A	Bath and Shower Trim, Standard Handles	<input type="checkbox"/> CP			
K-T7004-3A	Bath and Shower Trim, Cross Handles		<input type="checkbox"/> CP		
K-T7004-4A	Bath and Shower Trim, Lever Handle			<input type="checkbox"/> CP	
K-T7004-5A	Bath and Shower Trim, Wristblade Handles				<input type="checkbox"/> CP
K-T7226-2A	Shower Only Trim, Standard Handles	<input type="checkbox"/> CP			
K-T7226-3A	Shower Only Trim, Cross Handles		<input type="checkbox"/> CP		
K-T7226-4A	Shower Only Trim, Lever Handle			<input type="checkbox"/> CP	
K-T7226-5A	Shower Only Trim, Wristblade Handles				<input type="checkbox"/> CP
K-T7744-2	Valve Only Trim, Standard Handles	<input type="checkbox"/> CP			
K-T7744-3	Valve Only Trim, Cross Handles		<input type="checkbox"/> CP		
K-T7744-4	Valve Only Trim, Lever Handle			<input type="checkbox"/> CP	
K-T7744-5	Valve Only Trim, Wristblade Handles				<input type="checkbox"/> CP

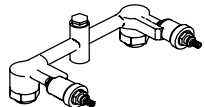
<b>Required Accessory</b>		
K-302-K	2-Handle 1/2" Ceramic Disc Valve System	<input type="checkbox"/> NA

**PRODUCT SPECIFICATION:**

Two-handle bath and shower faucet trim shall be of brass construction. Bath and shower trim shall include showerhead with arm and flange, 4-7/8" N.P.T. diverter spout, and handles. Shower only trim shall include showerhead with arm and flange, and handles. Valve only trim shall include handles. Trim shall be Kohler Model K-T \_\_\_\_\_ - \_\_\_\_\_ -CP and valve system shall be Kohler Model K-302-K-NA.

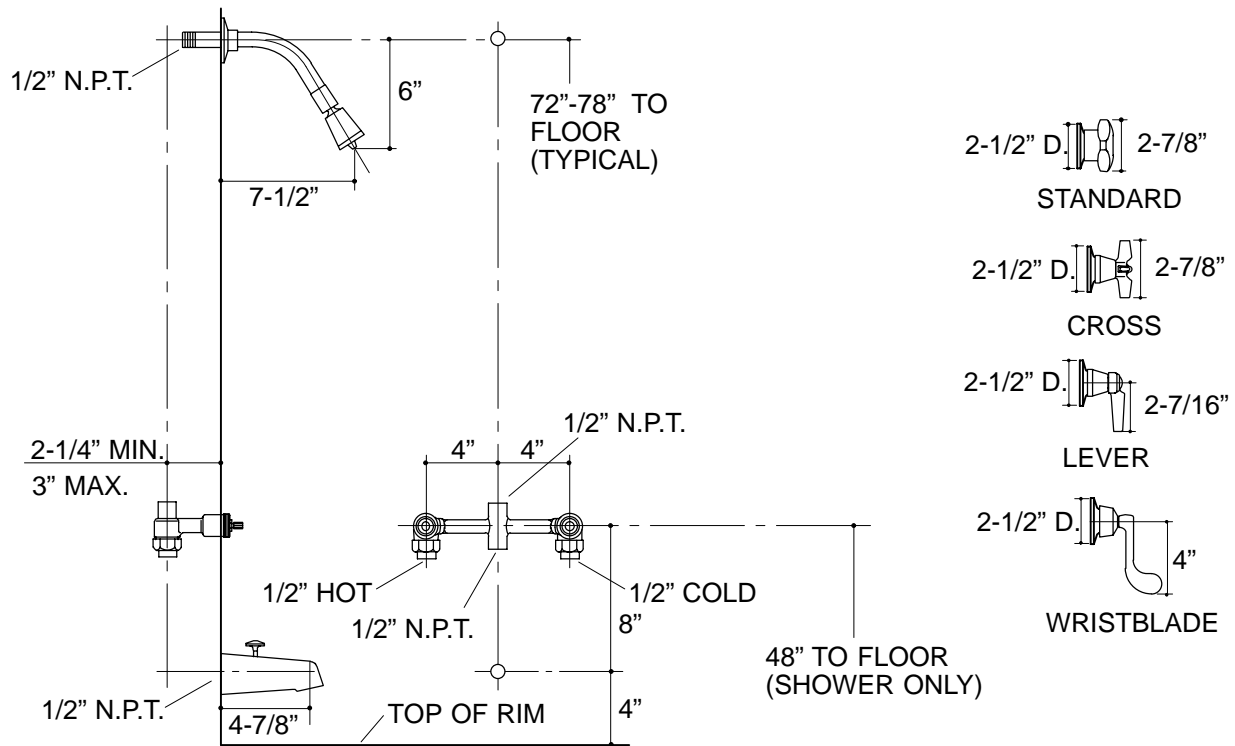

332

**PRODUCT DIAGRAM**