

Hardware

(Drawn to Scale)

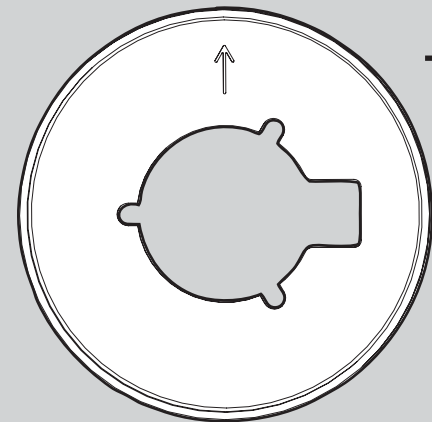

- x 1** Low Profile Washer
- x 2** 3" Wood Screw
- x 4** Flat Washer
- x 2** 1.5" Wood Screw
- x 3** Screw, Low Profile
- x 4** Canopy Screw
- x 1** Setscrew
- x 4** Mounting Isolator
- x 11** Screw, Blade Iron Armature
- x 16** Screw, Blade Assembly
- x 16** Blade Grommet
- x 3** Screw, Switch Housing Assembly
- x 3** Screw, Machine, 6-32

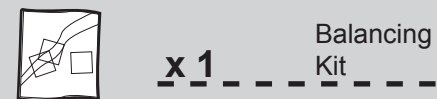

x 1 Balancing Kit

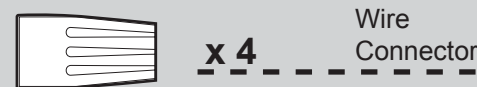

x 4 Wire Connector

Fan Parts

(Not Drawn to Scale)

Hanger Bracket Assembly

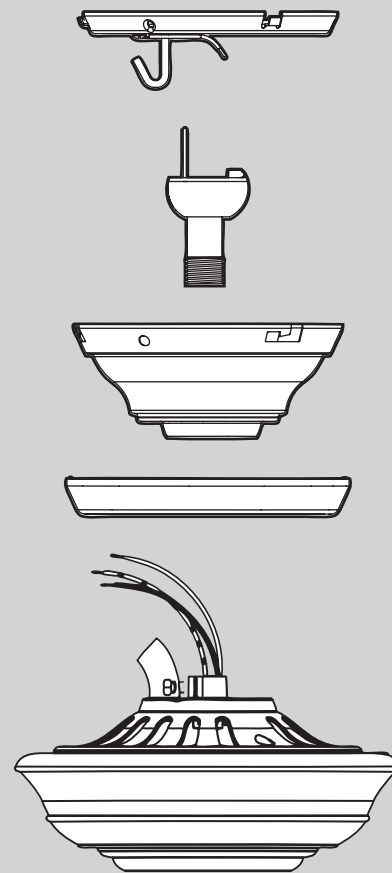

Blade Assembly

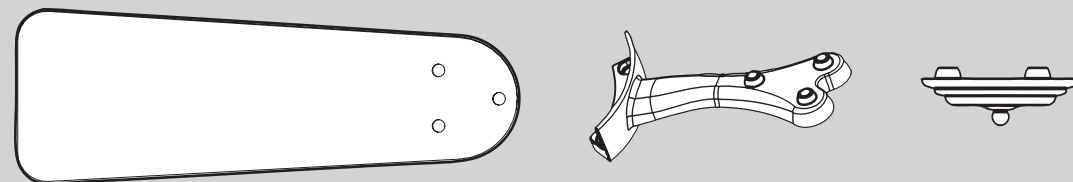

Switch Housing Assembly

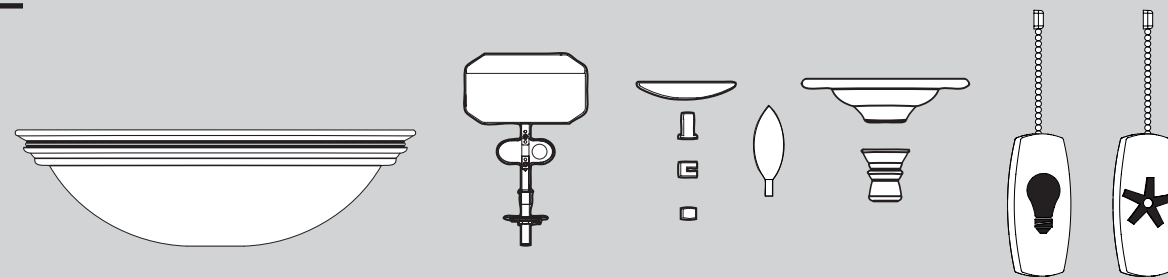

PARTS GUIDE

Hunter

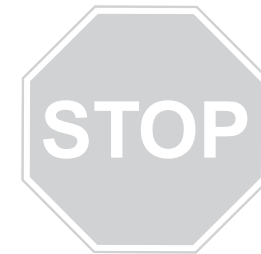

Using this Parts Guide, make sure all parts are included in the box.
If parts are missing, **DO NOT RETURN**

THIS ITEM TO THE STORE, call 888-830-1326 for assistance.

THIS PARTS GUIDE IS FOR REFERENCE ONLY.

REFER TO THE INSTALLATION MANUAL FOR FULL ASSEMBLY INSTRUCTIONS.

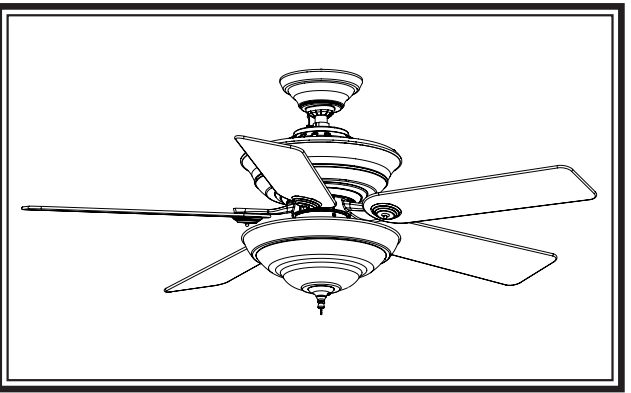

Parts List

Item Name	Qty	Part #
Hanging System Kit	1	94945-67
Ceiling Plate		
Canopy		
Canopy Trim Ring		
Hanger Ball / Downrod Assembly		
Setscrew		
Low Profile Washer		
Screw, Low Profile		
Canopy Screw		
Wood Screw 1.5"		
Wood Screw 3"		
Flat Washer		
Mounting Isolator		
Blade Iron Set	1	G0474-05
Blade Medallion	1	76201-05
Blade Set	1	G0761-32
Switch Housing Assembly	1	G0656-67
Light Kit Assembly	1	97231-01
Screw, Blade Iron Armature	11	63755-05
Hardware Kit	1	97531-00-860
Blade Grommet		
Blade Assembly Screw		
Screw, Machine, 6-32		
Wire Connector		
Screw, Switch Housing Assembly		
Balancing Kit	1	65666-01
Pull Chain	1	63756-18
Pull Chain	2	63756-58
Fan Pull Chain Pendant	1	G0090-01
Light Pull Chain Pendant	1	G0091-01
Globe/Shade	1	85188-01
Bottom Cap	1	66075-01
Finial	1	65798-01
Dummy Terminal, Male	1	08200-01
Dummy Terminal, Female	1	08198-01
Cap, Switch Housing	1	73853-01
Plug Button	1	73854-01
Light bulb / Bulb	2	77646-04

Materiales

(no dibujados a escala)

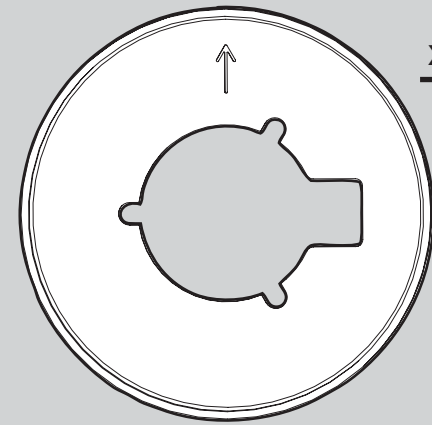

x 1

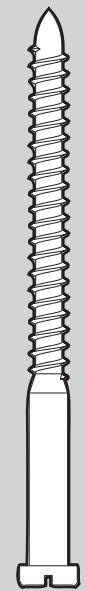

x 2

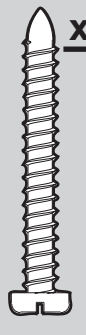

x 2



x 4

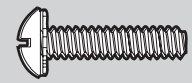

x 3

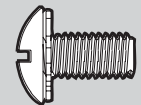

x 4

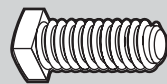

x 1

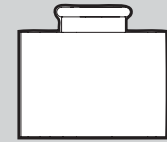

x 4



x 11

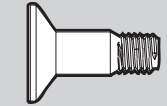

x 16

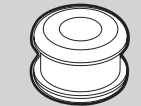

x 16



x 1



x 4

Kit de equilibrado

Empalme plástico

Roseta de perfil bajo

3" Tornillo de madera

Arandela plana

1.5" Tornillo de madera

Tornillo, de roseta de perfil bajo

Tornillo de campana

Tornillo prisionero

Aislador de montaje

Tornillo de armadura de soporte de paleta

Tornillo, de conjunto de paleta

Arandela de caucho de paleta

Tornillo, del conjunto de la caja del interruptor

Tornillo mecánico, 6-32

Piezas del ventilador

(no dibujadas a escala)

Conjunto del soporte de suspensión

de conjunto de paleta

Conjunto del interruptor

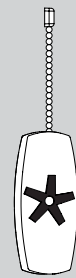
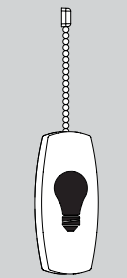
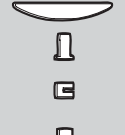
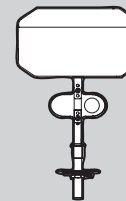
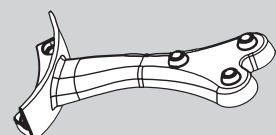
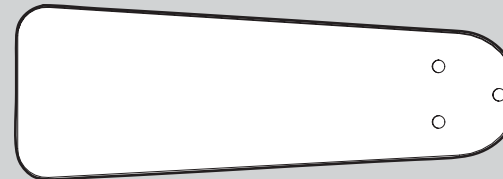
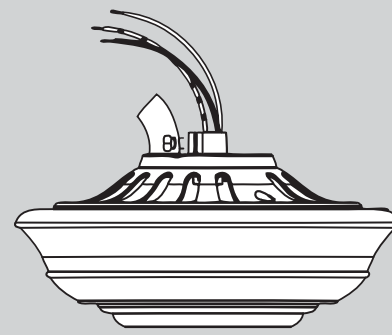
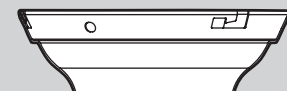
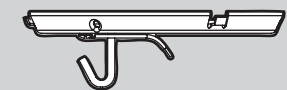

ALTO

Hunter

Consulte esta Guía de partes para asegurarse de que todas las partes estén incluidas en la caja.

Si falta alguna parte, NO DEVUELVA ESTE PRODUCTO A LA TIENDA. Solicite ayuda al 888-830-1326. ESTA GUÍA DE PARTES SOLAMENTE ES REFERENCIAL. CONSULTE LAS INSTRUCCIONES COMPLETAS DE ENSAMBLAJE EN EL MANUAL DE INSTALACIÓN

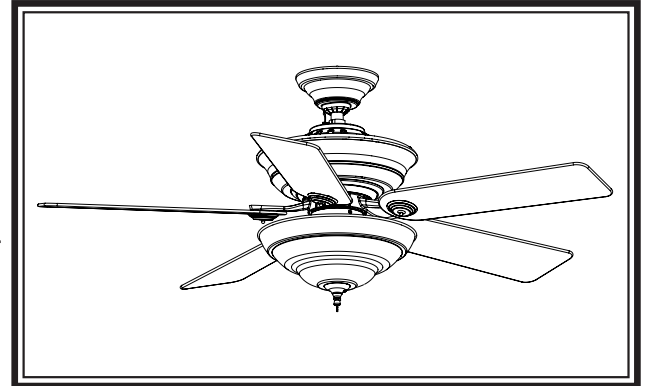

Lista de piezas

Nombre del ítem	No. del modelo	
	No. del dibujo de ensamblaje	20552
	Acabado	97531-01
	Cantidad	Cocoa
Kit del sistema de suspensión	1	94945-67
Placa de techo		
Campana		
Anillo de la moldura de campana		
Bola de suspensión / Conjunto de varilla		
Tornillo prisionero		
Roseta de perfil bajo		
Tornillo, de roseta de perfil bajo		
Tornillo, de campana		
Tornillo, de madera		
Tornillo, de madera		
Arandela, plana		
Aislador de montaje		
Juego de soporte de paletas	1	G0474-05
Medallón de la paleta	1	76201-05
Juego de paletas	1	G0761-32
Conjunto del interruptor	1	G0656-67
Conjunto del kit de luz	1	97231-01
Tornillo, de armadura de soporte de paleta	11	63755-05
Kit de materiales	1	97531-00-860
Arandela de caucho, de paleta		
Tornillo, de conjunto de paleta		
Tornillo, mecánico, 6-32		
Empalme plástico		
Tornillo, del conjunto de la caja del interruptor		
Kit de equilibrado	1	65666-01
Tirador de cadena	1	63756-18
Tirador de cadena	2	63756-58
Pendiente del tirador de cadena del ventilador	1	G0090-01
Pendiente del tirador de cadena de luz	1	G0091-01
Globo / Pantalla	1	85188-01
Tope inferior	1	66075-01
Cubierta ornamental	1	65798-01
Terminal simulado, macho	1	08200-01
Terminal simulado, hembra	1	08198-01
Tapa, Caja del interruptor	1	73853-01
Botón taponador	1	73854-01
Bombilla	2	77646-04