

Family: Saturn | Item No. 1904 OI/MT/VK

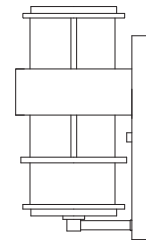

Drawing 1 - Fixture Mounting

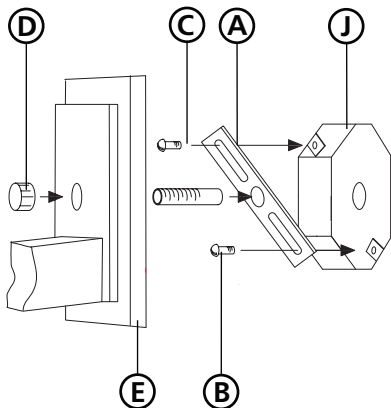

Drawing 2 - Glass Installation

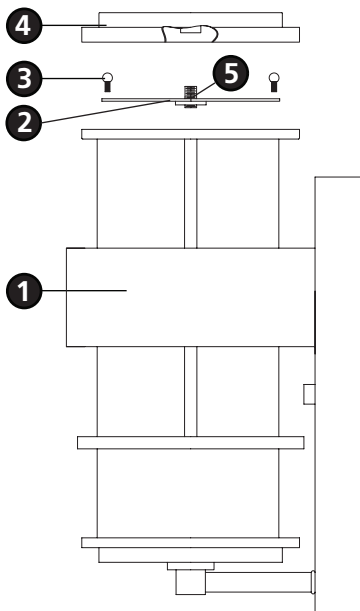

▼ start here

1

1. Find a clear area in which you can work.
2. Unpack fixture and glass from carton.
3. Carefully review instructions prior to assembly.

***** The construction of this fixture will be accomplished by first lamping the fixture, installing the mounting hardware, making all necessary electrical connections, and then mounting the fixture to the wall.**

2

1. To lamp fixture, remove top strap (2), located at the top of the main body assembly (1) by removing the two ball knob screws (3) from each end of the strap (2) - see **Drawing 2**.
2. Fixture can now be lamped accordingly.
3. Replace strap (2) and secure with ball knob screws (3) removed earlier.
4. Thread roof of fixture (4) onto nipple (5).

3

1. Prepare mounting strap (A) by threading 1-5/8" nipple into the center hole of the mounting strap (A), approximately 1/4".- see **Drawing 1**.
2. Attach mounting strap (A) to junction box (J) using two 1" screws (C).

SAFETY WARNING: READ WIRING AND GROUNDING INSTRUCTIONS (I.S. 18) AND ANY ADDITIONAL DIRECTIONS. TURN POWER SUPPLY OFF DURING INSTALLATION. IF NEW WIRING IS REQUIRED, CONSULT A QUALIFIED ELECTRICIAN OR LOCAL AUTHORITIES FOR CODE REQUIREMENTS.

4

Make electrical connections from supply wire to fixture lead wires. Refer to instruction sheet (I.S. 18) and follow all instructions to make all necessary wiring connections. Then refer back to this sheet to continue installation of this fixture.

5

1. To mount fixture, slip center hole of backplate (E) over nipple (C) and hold fixture in position - see **Drawing 1**.
2. Thread decorative knob (D) onto end of nipple (C) and tighten to secure fixture.

Note: Maximum wattage for 1904 fixture is 75 watts per bulb.

2.7.08