



GOLDEN
Elegant lighting for everyday living

PARTS & ASSEMBLY SHEET









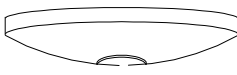

Fixture Name: Empyreal 1220-M3 RT

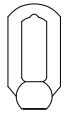
This fixture assembled PO: _____ Date: _____

Notice: Please review the parts listing and check for all parts before assembling the fixture. If any parts are missing or damaged, please note on this sheet and contact the place of purchase to arrange for replacement parts.

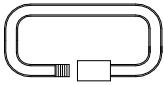
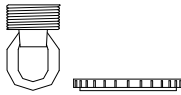
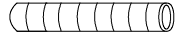
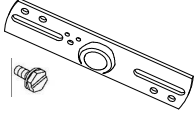
PARTS LIST

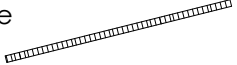
Company Name: _____ Co. Account #: _____
to be filled out by retailer

Canopy 1ea @5"Dia x 1"E 	Wire connectors 3ea P3 Orange 	Top loop 1ea 3/8"IP*H80mm 
Chain 1ea 6ft x 5.0mm 	Junction Box Screw 2ea #8-32N*H25mm 	Spring Washer 1ea Φ15*H3mm 
Chain connector 2ea Φ4*H55mm 	Canopy Loop with Collar 1ea @3/8 x 42.4mm x 5mm loop 	Nipple 1ea @3/8 x 45mm 
Mounting Strap w/ ground screw 1ea 3/4"x4" 	Hex Nut 1ea @3/8 x 3mm 	Threaded Pipe 1ea 3/8"*H390mm 
Center Tube 1ea Φ13*H362mm 	Center Column 1ea Ø106*H388mm 	
Part Needed _____	Quantity _____	
Part Needed _____	Quantity _____	
Reason why _____	(missing, scratched, broken glass, bent, bad finish)	
Comments _____		

FIXTURE ASSEMBLY INSTRUCTIONS

Read and review installation instruction sheet before assembling the fixture.

ASSEMBLING THE FIXTURE (Fig. 1)

1. This fixture is packed with the arms closed. Gently spread the arms (L) until evenly spaced.
2. Feed the fixture wires through inside of Threaded Pipe (M) and pull the fixture wires until taut.
3. Screw the Threaded Pipe (M) to fixture Coupler (R).
4. Slide Center Column (N) onto Threaded Pipe (M) and screw the Top Loop (J) to the top of the Threaded Pipe (M) until tight.

NOTE: INSTALL THE SHADE ASSEMBLY AFTER THE FIXTURE IS HUNG.

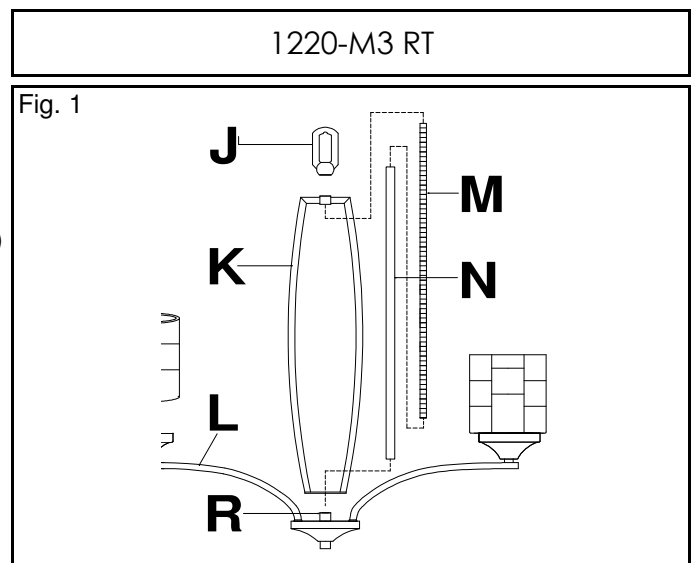

For Customer Service, contact the place of purchase to arrange for replacement parts.

PARTS & ASSEMBLY SHEET

Fixture Name: Empyreal 1220-M3 RT

5. By measuring determine correct number of links needed for proper hanging height. Use a pair of pliers to open one link of the Chain (K) then remove the excess Chain (K) and discard it.
 6. Use one chain connector (L) to attach one end of the chain to the Top loop (J) and close the chain connector.
 7. Feed the fixture wires through the Chain (every three links) and pull the wires until taut.
 8. Slip Canopy loop collar (H) over the chain, then do the same with the canopy (G).
 9. When ready to complete the installation Use the other chain connector and attach the other end of the chain to the canopy loop (F) and close the chain connector.
 10. Make sure the weight of the chandelier will be supported by the chain-not the electrical wire.
- * You may now install the fixture.
- Note: Complete these remaining steps after the fixture is hung.
10. Place the Shades (P) over the Threaded Sockets (Q), secure the Shades (P) by threading by the Socket Rings (O) until tight.
 11. Install the light bulbs in accordance with the fixture's specifications.

(DO NOT EXCEED MAXIMUM WATTAGE RATING)

Fig 2

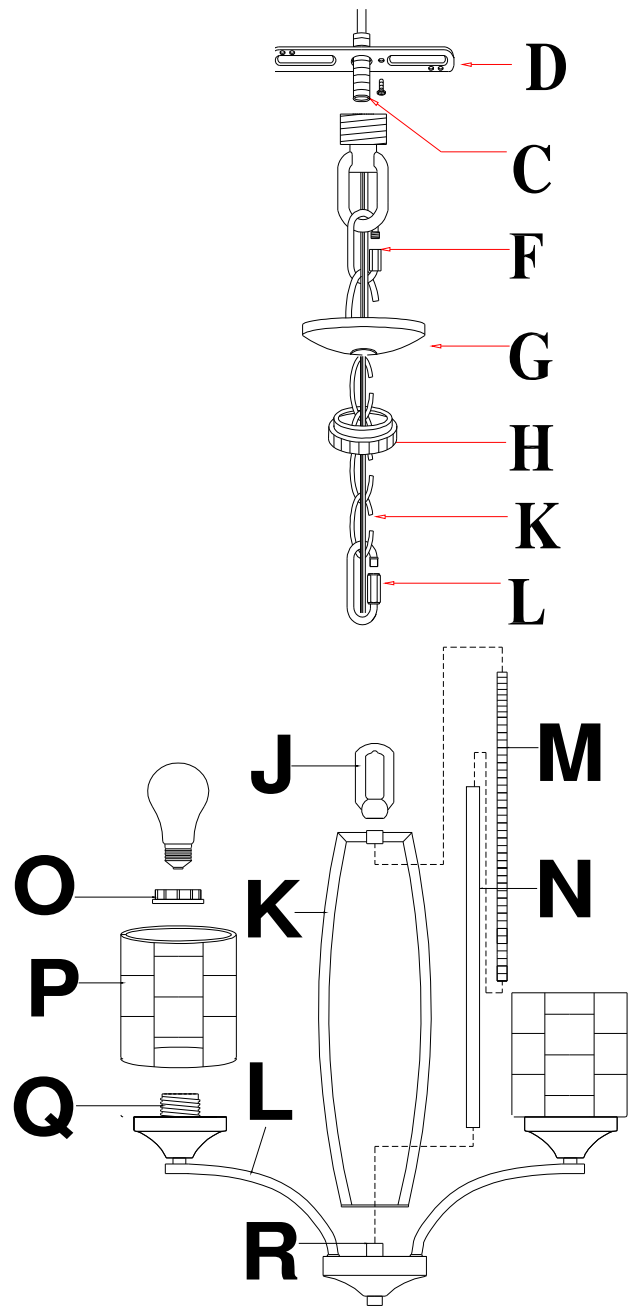

DO NOT put the stone shades in dishwasher.
To clean - wipe with damp cloth

For Customer Service, contact the place of purchase to arrange for replacement parts.

WARNING ! SHUT OFF POWER AT FUSE OR CIRCUIT BREAKER.

HANGING THE FIXTURE (Fig.1)

1. Carefully remove the new fixture from the carton and the yellow bag that holds all parts. Check that all parts are included as shown in the illustration and parts list.
2. Shut off the power at the circuit breaker and remove old fixture from ceiling, including the old mounting strap.
3. Thread Nipple (C) into Canopy Loop (F) until snug.
4. Thread other end of the Nipple (C) with Canopy Loop attached into Mounting Strap (D).
5. Place Lock Washer (B) over end of Nipple (C) protruding through Mounting Strap (D) and thread Hex Nuts (A) onto Nipple until tight.
6. Take this mounting strap assembly and mount to ceiling junction box with junction box Screws (E). Tighten screw securely with screw driver.
7. Unscrew the Canopy loop collar (H) from the Canopy loop. Take the canopy and pass over the Canopy loop. approximately one half of the canopy loop exterior threads should be exposed. Adjust until desired height is reached. *the Canopy loop collar should fit snugly on the Canopy loop after the canopy is installed. Remove Canopy and Canopy lock collar.
8. Assemble the fixture and have an assistant or secure support hold the weight of the fixture while you complete the wiring connections.
9. Thread the fixture wires and ground wire of the assembled fixture through the canopy loop and nipple and into the outlet box.

CONNECTING THE WIRES (Fig 2)

10. Attach the power supply wires to the fixture lead wires by connecting BLACK to BLACK (or SMOOTH) and WHITE to WHITE (or RIBBED).
11. Attach the GROUND wire (GREEN or COPPER) from the Junction Box and the fixture Ground wire to the green Ground Screw on the Mounting Bracket (D) or connect both wires together using the correct size of wire connectors.

NOTE: Twist the wires together in the same direction you twist the wire connector onto the wires.

12. Tuck these wire connections neatly into the Junction Box.
13. Raise Canopy (G) to the ceiling and secure in place by tightening the Canopy loop collar (H) into the Canopy Loop (F)
14. Install the light bulbs and glass shade as per the fixture assembly sheet.

Fig. 1

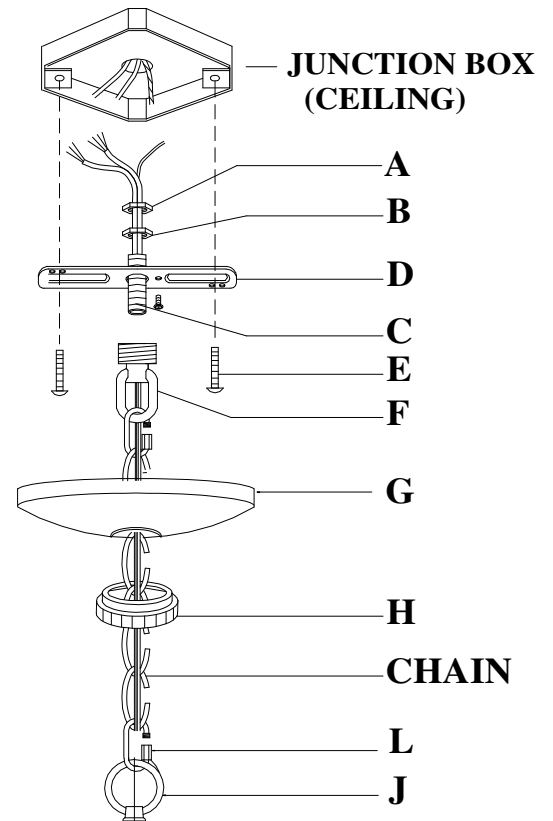
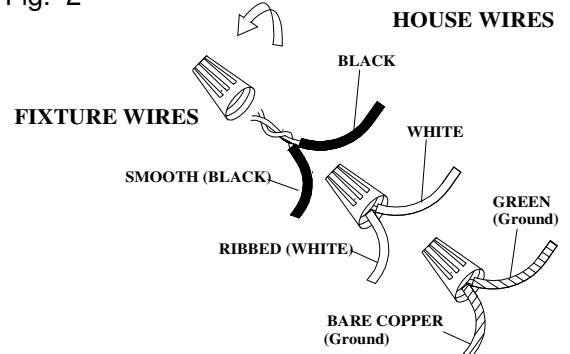

Fig. 2



**YOUR INSTALLATION IS NOW COMPLETE.
RETURN POWER TO THE JUNCTION BOX
AND TEST THE FIXTURE.**