

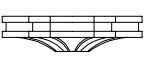

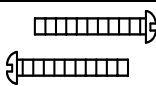









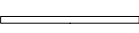
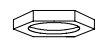

Notice: Please review the parts listing and check for all parts before assembling the fixture. If any parts are missing or damaged, please note on this sheet and contact the place of purchase to arrange for replacement parts.

PARTS LIST

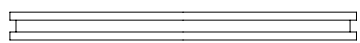
Company Name: _____ Co. Account #: _____
to be filled out by retailer

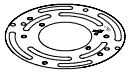
Canopy	1ea 	Mounting Screws	2ea 	Top loop	1ea 
Chain	6ft 	Wire Connectors	3ea 	Nipple-A NIPPLE-B	1ea 
Chain connector	2ea 	Canopy Loop with Collar	1ea 	Mounting Strap	1ea 
Rubber washer	1ea 	Hex Nut	3ea 	Deco Screw (U) Finial (V)	3ea  1ea 
Fixture ring	1ea 			Bottom cap	1ea 
Mounting Strap	1ea 	Deco Nut	2ea 		
Part Needed	_____			Quantity	_____
Part Needed	_____			Quantity	_____
Reason why	(missing, scratched, broken glass, bent, bad finish)				
Comments	_____				

FIXTURE ASSEMBLY INSTRUCTIONS

Read and review installation instruction sheet before assembling the fixture.

ASSEMBLING THE FIXTURE as Semi flush (Fig. 1)

1. Thread the Fixture ring(E3) onto the Arm(E2) with the Finial (E1).
2. Thread the Nipple (D3) into the Coupling (D1), and then thread the Hex Nut (D2) onto Nipple (D3) until tight.
3. Install the light bulbs in accordance with the fixture's specification .
4. Place the Glass Shade (D4) over the Ceiling Pan . The Nipple (D3) shall protrude the bottom hole of the Glass Shade (D4).
5. While holding the Glass Shade (D4) slide the Rubber Washer (D6) and Iron Washer (D5) over Nipple (D3) and thread Hex Nut (D7) until tight.
6. Slide Bottom Cap (D8) over Nipple (D3) and thread the Finial (D9) until tight.
(DO NOT EXCEED MAXIMUM WATTAGE RATING!)

NOTE: INSTALL THE GLASS ASSEMBLY AFTER THE FIXTURE IS HUNG.

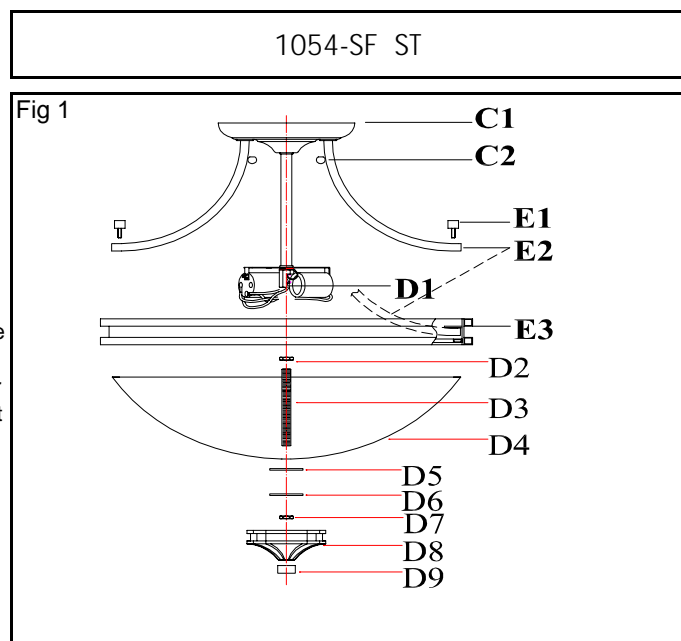

PARTS & ASSEMBLY SHEET

Fixture Name: Sterne 1054-SF ST

ASSEMBLING THE FIXTURE as Chain hung (Fig.2)

1. Remove the Circular strap from top of Fixture and replace the long mounting screws with two short screws to hold the Deco nuts (E) in place on the fixture Top cap (D).
2. Feed the fixture wires through the Top loop (D0) and pull the wires until taut. Then screw the Top Loop (D0) to the coupling on the top of fixture (D) until tight.
3. By measuring determine correct number of links needed for proper hanging height. Use a pair of pliers to open one link of the Chain (C2) then remove the excess Chain (C2) and discard it.
4. Use one chain connector(E2) to attach one end of the chain to the Top loop (D0) and close the chain connector.
5. Feed the fixture wires through the Chain (every three links) and pull the wires until taut.
6. Slip Canopy loop collar (B2) over the chain, then do the same with the canopy (F2).
7. When ready to complete the installation Use the other chain connector and attach the other end of the chain to the canopy loop (A2) and close the chain connector.
8. Make sure the weight of the chandelier is supported by the chain-not the electrical wire.

Fig 2

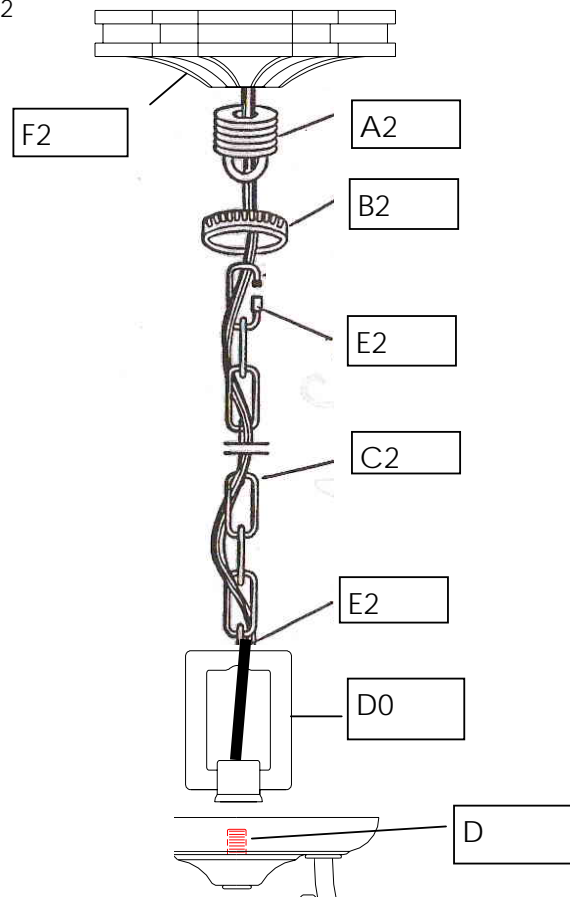

9. Thread the Fixture ring (E3) onto the Arm (E2) with the Finia (E1).
10. Thread the Nipple (D3) into the Coupling (D1), and then thread the Hex Nut (D2) onto Nipple (D3) until tight.

* You may now install the fixture.

11. Install the lighting bulbs in accordance with the fixture's specification .
12. Place the Glass Shade (D4) over the Ceiling Pan . The Nipple (D3) shall protrude the bottom hole of the Glass Shade (D4).
13. While holding the Glass Shade (D4) slide the Rubber Washer (D6) and Iron Washer (D5) over Nipple (D3) and thread Hex Nut (D7) until tight.
14. Slide Bottom Cap (D8) over Nipple (D3) and thread the Finial (D9) until tight.

(DO NOT EXCEED MAXIMUM WATTAGE RATING!)

Fig 3

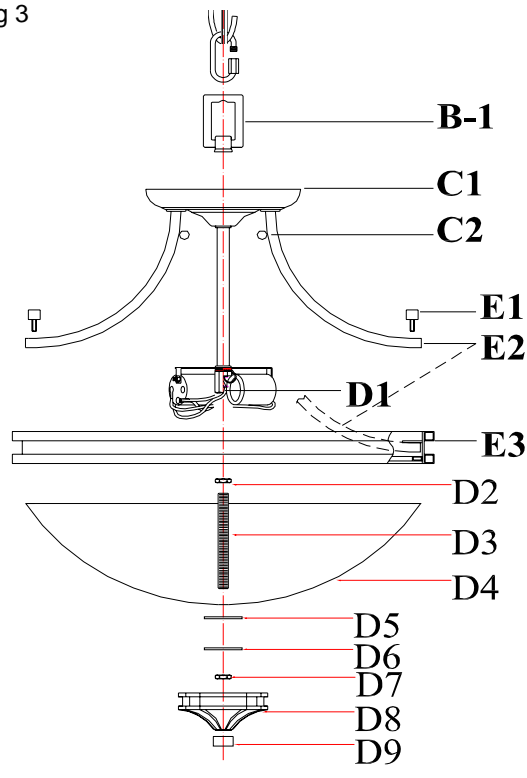

For Customer Service, contact the place of purchase to arrange for replacement parts.

Fixture Name: Sterne 1054-SF ST

For Semi Flush / Convertible Light Fixture

WARNING ! SHUT OFF POWER AT FUSE OR CIRCUIT BREAKER.

HANGING THE FIXTURE as Semi flush (Fig. 1)

- Carefully remove the new fixture from the carton and the yellow bag that holds all your parts. Check that all parts are included as shown in the illustration and parts list.
- Shut off power at the circuit breaker and remove the old fixture from ceiling, including the old mounting strap.
- The Circular Strap (A) contains several pairs of threaded holes, find the pair of holes that match the hole spacing in your fixture Back Plate (D) and thread the two Mounting Screws (C) half way into the Mounting Strap (A) facing down, Secure in place with hex nuts. These will have their threaded ends protrude through the two holes in the fixture canopy(D).
- Place the Mounting Strap (A) over the junction
- Attach the Mounting Strap (A) to the Junction Box using the two mounting screws (B). Tighten the screws (B) securely with screw driver.

CONNECTING THE WIRES (Fig 2)

- Attach the power supply wires to the fixture lead wires by connecting BLACK to BLACK (or SMOOTH) and WHITE to WHITE (or RIBBED).
- Attach the GROUND wire(GREEN or COPPER) from the Junction Box and the fixture Ground wire to the green Ground Screw on the Mounting Bracket (B) or connect both wires together using the correct size of wire connectors.

NOTE: Twist the wires together in the same direction you twist the wire connector onto the wires.

- Tuck these wire connections neatly into the Junction Box.

FINISHING THE INSALLATION (Fig.3)

- Place the fixture's canopy over the Mounting Strap (A) and over the Mounting Screws (C), adjust the fixture canopy (D) until the Mounting Screws (C) protrude out from the canopy (D) and secure the fixture against the ceiling by threading the decorative nuts(E) until tight.
- Install the light bulbs and glass shade as per the fixture assembly sheet.

YOUR INSTALLATION IS NOW COMPLETE. RETURN POWER TO THE JUNCTION BOX AND TEST THE FIXTURE.

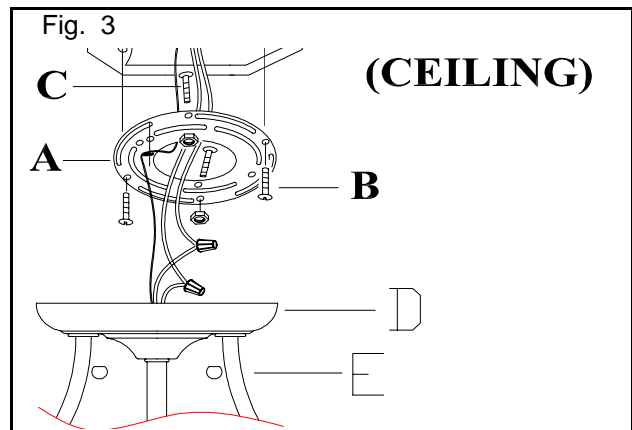
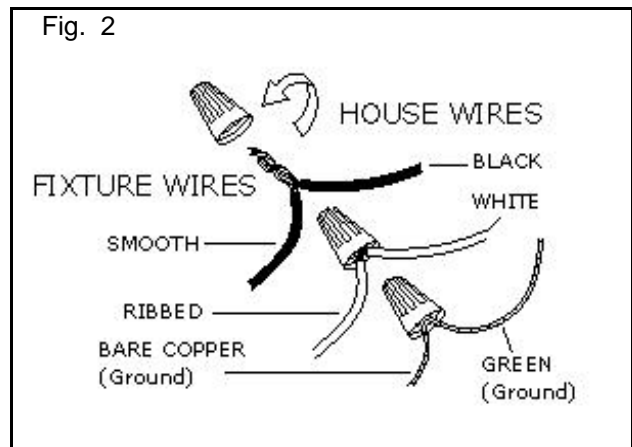
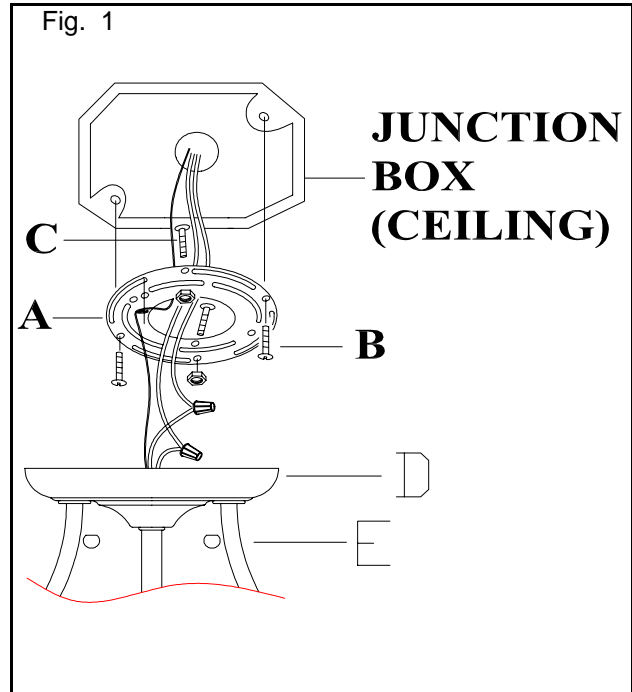

Fixture Name: Sterne 1054-SF ST

For Chandelier Light Fixture

WARNING ! SHUT OFF POWER AT FUSE OR CIRCUIT BREAKER.

HANGING THE FIXTURE (Fig.1)

- Carefully remove the new fixture from the carton and the yellow bag that holds all parts. Check that all parts are included as shown in the illustration and parts list.
- Shut off the power at the circuit breaker and remove old fixture from ceiling, including the old mounting strap.
- Thread Nipple(C) into Canopy Loop (F) until snug.
- Thread other end of the Nipple (C) with Canopy Loop attached into Mounting Strap (D).
- Place Lock Washer (B) over end of Nipple (C) protruding through Mounting Strap (D) and thread Hex Nuts (A) onto Nipple until tight.
- Take this mounting strap assembly and mount to ceiling junction box with junction box Screws (E). Tighten screw securely with screw driver.
- Unscrew the Canopy loop collar(H) from the Canopy loop. Take the canopy and pass over the Canopy loop. approximately one half of the canopy loop exterior threads should be exposed. Adjust until desired height is reached. *the Canopy loop collar should fit snugly on the Canopy loop after the canopy is installed. Remove Canopy and Canopy lock collar.
- Assemble the fixture and have an assistant or secure support hold the weight of the fixture while you complete the wiring connections.
- Thread the fixture wires and ground wire of the assembled fixture through the canopy loop and nipple and into the outlet box.

CONNECTING THE WIRES (Fig 2)

- Attach the power supply wires to the fixture lead wires by connecting BLACK to BLACK (or SMOOTH) and WHITE to WHITE (or RIBBED).
- Attach the GROUND wire(GREEN or COPPER) from the Junction Box and the fixture Ground wire to the green Ground Screw on the Mounting Bracket (D) or connect both wires together using the correct size of wire connectors.

NOTE: Twist the wires together in the same direction you twist the wire connector onto the wires.

- Tuck these wire connections neatly into the Junction Box.

FINISHING THE INSTALLATION

- Raise Canopy (G) to the ceiling and secure in place by tightening the Canopy loop collar(H) onto the Canopy Loop(F). Install the light bulbs and glass shade as per the fixture assembly sheet.

Fig. 1

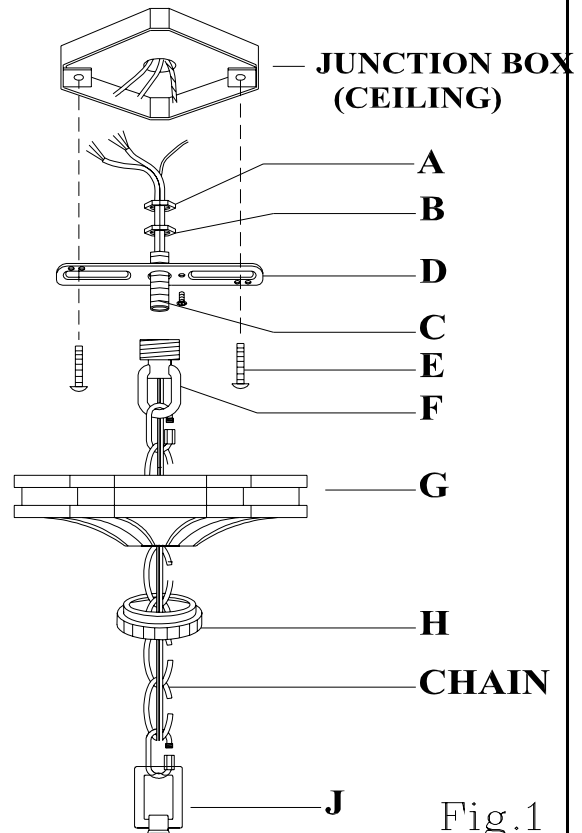
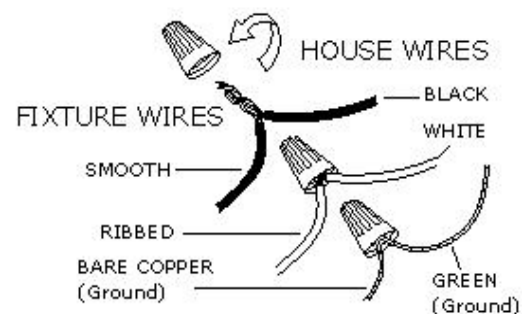

Fig.1

Fig. 2



**YOUR INSTALLATION IS NOW COMPLETE.
RETURN POWER TO THE JUNCTION BOX AND
TEST THE FIXTURE.**