







Fixture Name: TWIST 8013-BA3 PC

This fixture assembled PO: _____ Date: _____

Notice: Please review the parts listing and check for all parts before assembling the fixture. If any parts are missing or damaged, please note on this sheet and contact the place of purchase to arrange for replacement parts.

PARTS LIST

Company Name: _____ Co. Account #: _____
below to be filled out by retailer

<p>Circular Mounting Strap</p>  <p>1ea $\Phi 4'' \times H1.2\text{mm}$</p>	<p>Mounting screw</p>  <p>2ea 8/32-IP*1"</p>	<p>Mounting screw</p>  <p>2ea 5/32-IP*1-1/4"</p>
<p>Hex nut</p>  <p>2ea 5/32-IP*H3mm</p>	<p>Wire connector</p>  <p>2ea A3 Orange</p>	<p>Deco nuts</p>  <p>2ea 5/32-IP*H9mm</p>

Part Needed	_____	Quantity	_____
Part Needed	_____	Quantity	_____
Reason why	(missing, scratched, broken glass, bent, bad finish)		
Comments	_____		

FIXTURE ASSEMBLY INSTRUCTIONS

Read and review installation instruction sheet before assembling the fixture.

8013-BA3 PC

- Place the Glass Shade (H) over the Socket (G).
- Holding the Glass Shade (H) and secure it by threading the Socket Ring (I) onto the Threaded Socket (G) until tight.
- Install the lighting bulbs in accordance with the fixture's specification.
(DO NOT EXCEED THE MAXIMUM WATTAGE RATING!)

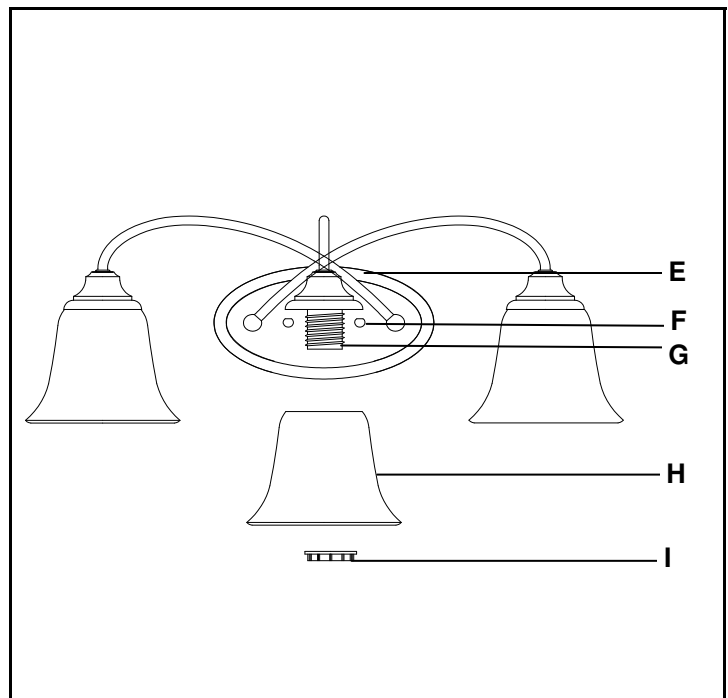

NOTE: INSTALL THE GLASS ASSEMBLY AFTER THE FIXTURE IS HUNG.

For Customer Service, contact the place of purchase to arrange for replacement parts.

WARNING ! SHUT OFF POWER AT FUSE OR CIRCUIT BREAKER.

HANGING THE FIXTURE (Fig 1)

1. Carefully remove the new fixture from the carton and the yellow bag that holds all your parts. Check that all parts are included as shown in the illustration and parts list.
2. Shut off power at the circuit breaker and remove the old fixture from wall, including the old mounting strap.
3. The Mounting Strap (B) contains several pairs of threaded holes, find the pair of holes that match the holes spacing in your fixture Back Plate (E) and thread the two Fixture Mounting Screws (C) half way into the Fixture Mounting Strap (B).
4. Place the Mounting Strap (B) over the Junction Box so the Fixture Mounting Screws (C) are vertical or horizontal, as required by the fixture type.
5. Attach the Fixture Mounting Strap (B) to the Junction Box using the two mounting screws (A). Tighten the screws (A) securely with screwdriver.

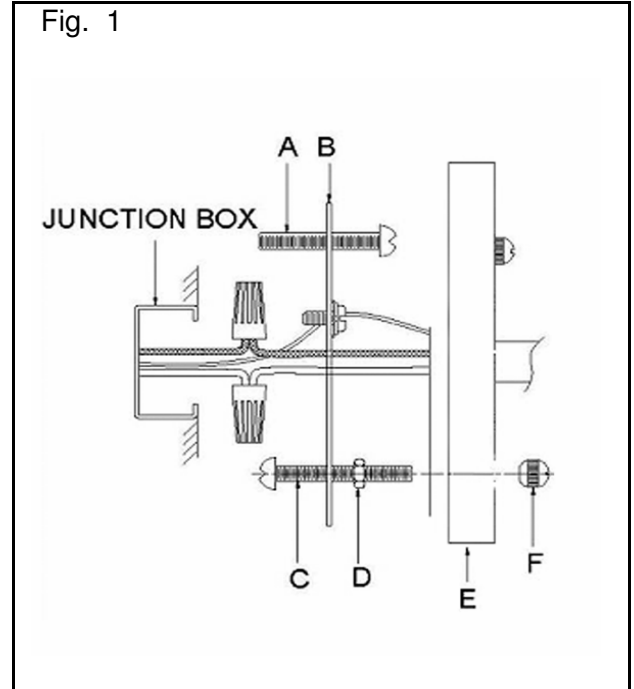

CONNECTING THE WIRES (Fig 2)

6. Attach the power supply wires to the fixture lead wires by connecting BLACK to BLACK (or SMOOTH) and WHITE to WHITE (or RIBBED).
 7. Attach the GROUND wire (GREEN or COPPER) from the Junction Box and the fixture Ground wire to the green Ground Screw on the Mounting Bracket (B) or connect both wires together using the correct size of wire connectors.
- NOTE: Twist the wires together in the same direction you twist the wire connector onto the wires.
8. Tuck these wire connections neatly into the Junction Box.

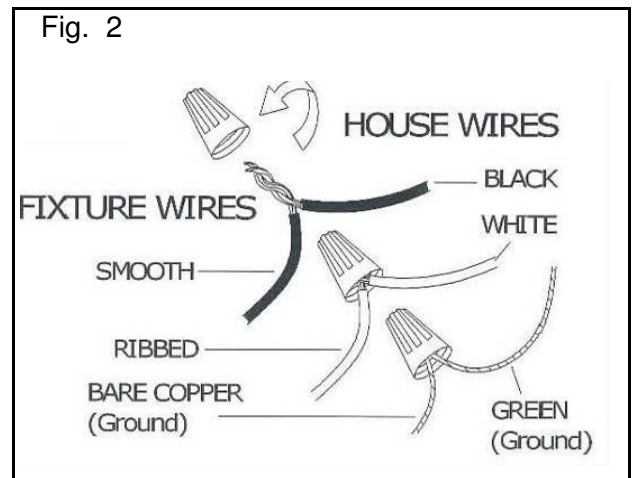

FINISHING THE INSTALLATION (Fig 3)

9. Place the fixture Back Plate (E) over the two Mounting Screws (C) and secure the Back Plate (E) against the wall by threading two Deco nuts (F) over the two Mounting Screws (C) until tight as shown on Fig.1

YOUR INSTALLATION IS NOW COMPLETE. RETURN POWER TO THE JUNCTION BOX AND TEST THE FIXTURE.

