

Single Basin Faucet

TECK®

DELTA
COMMERCIAL

Specification: (example)

- **CAST BRASS** single basin faucet
- Polished chrome plated
- TUF-TECK institutional structure
- Color indexed metal handle with vandal resistant screw
- Metal hold-down package and ...
- with ... (add outlet required)
- with ... (add handle required)



Engineer/Architect Approval









Model Specified:

Approval:

Date:

DESCRIPTION	PRODUCT NO.		
Single Basin Faucet	23TI	0	



NOT APPLICABLE	OUTLET	HANDLE
0 <input checked="" type="checkbox"/>	0 <input checked="" type="checkbox"/>	0 <input type="checkbox"/>
1 <input type="checkbox"/>	1 <input type="checkbox"/>	1 Five Flute Handle  <input type="checkbox"/>
2 <input type="checkbox"/>	2 Vandal Resistant 1.5 USGPM (5.7 L/min.) Laminar w/Antimicrobial By AgION™  <input type="checkbox"/>	2 <input type="checkbox"/>
3 <input type="checkbox"/>	3 Vandal Resistant 1.5 USGPM (5.7 L/min.) Flow Control Aerator  <input type="checkbox"/>	3 70mm (2-3/4") Lever Blade Handle  <input type="checkbox"/>
4 <input type="checkbox"/>	4 Standard 1.5 USGPM (5.7 L/min.) Flow Control Aerator  <input type="checkbox"/>	4 <input type="checkbox"/>
5 <input type="checkbox"/>	5 Vandal Resistant 0.5 USGPM (1.9 L/min) Flow Control Non-Aerating Spray Outlet  <input type="checkbox"/>	5 <input type="checkbox"/>
6 <input type="checkbox"/>	6 <input type="checkbox"/>	6 <input type="checkbox"/>
7 <input type="checkbox"/>	7 <input type="checkbox"/>	7 <input type="checkbox"/>
8 <input type="checkbox"/>	8 <input type="checkbox"/>	8 70mm (2-3/4") Self-closing Lever Blade Handle  <input type="checkbox"/>
9 <input type="checkbox"/>	9 <input type="checkbox"/>	9 Five Flute Self-closing Handle  <input type="checkbox"/>

See Back Page for Faucet Pairs
Refer to www.specselectonline.com for individual models.

Flowrates are at 60 PSI.
Note: Use this page front and back as a product submittal sheet.

Delta reserves the right (1) to make changes in specifications and materials, and (2) to change or discontinue models, both without notice or obligation. Dimensions are for reference only. See current full-line price book or www.specselectonline.com for finish options and product availability.

Approvals:

- CSA certified
- Complies to ASME A112.18.1
- Lever Blade Handle No. 3, ADA Compliant and meets Handicapped Accessibility Standard ASME A117.1 of less than 5 lbs. operating force.
- IAPMO listed

(Contact Delta Representative for State and/or Local Approvals.)

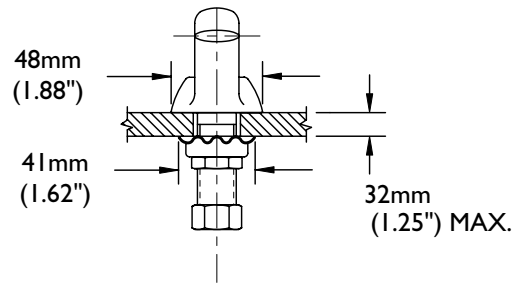
FRONT VIEW

INLET FOR 3/8" OR 1/2" FLEXIBLE RISER
OR 1/2-14 NPSM COUPLING NUT (SUPPLIED)

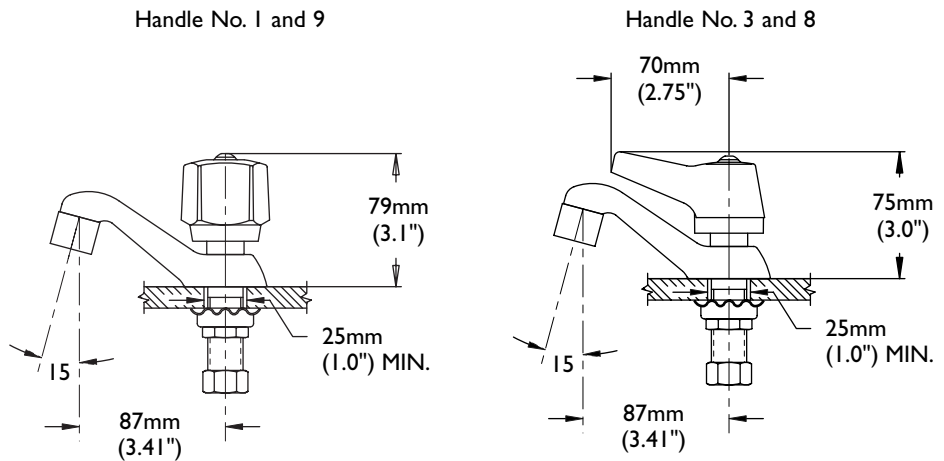
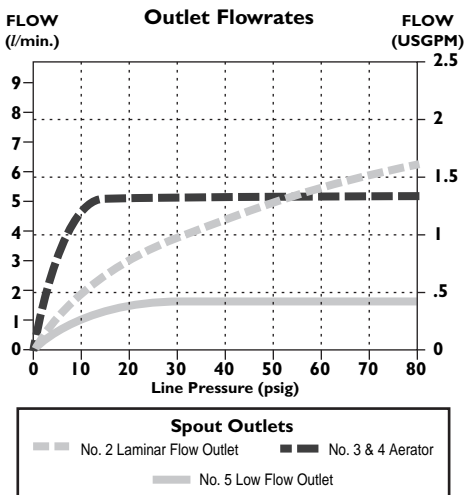
SIDE VIEW

FLOWRATE vs PRESSURE

Specification: (Example)

- **23T101**
Pair of single hole mount, cast brass, polished chrome plated finish, basin faucets, TUF-TECK institutional structure, color indexed five flute metal handle with vandal resistant screw and 1.5 USGPM (5.7 L/min) at 60 PSI aerator outlet.
(2 x 23T1041)
- **23T24A**
As above but with self-close handle.
(2 x 23T1049)

INLETS - 1/2" MIP/Coupling Nuts

Note: Measurements may vary \pm 6mm (0.25")

Refer to www.specselectonline.com for individual models.

Note: Use this page front and back as a product submittal sheet.