

COMMERCIAL STEAM GENERATOR WITH COOLFLUSH™ AUTO DRAIN OPTION

BOILERS FOR LARGE STEAM ROOMS

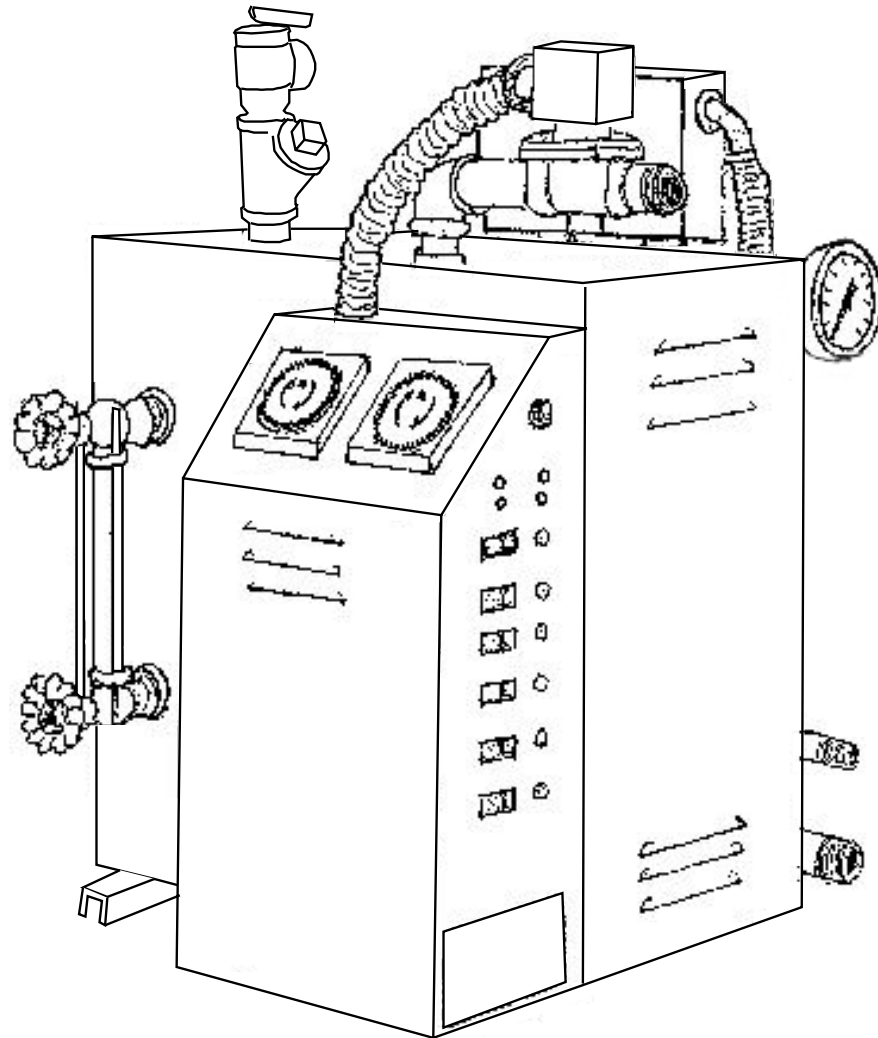

INSTALLATION INSTRUCTIONS
MODELS AI 12, AI 18 & AI 24 and
MODELS AI 30, AI 36, AI 42 & AI 48
WITH COOLFLUSH™ AUTO DRAIN OPTION

INDEX

<u>SECTION</u>	<u>PAGE</u>
WARNINGS	3
GENERAL INFORMATION	4
WATER QUALITY REQUIREMENTS	4
BOILER RATINGS	5
DIMENSIONS	6
INSTALLATION	7
GENERATOR	7
PLUMBING	7
WATER LINE	7
STEAM LINE	8
SAFETY VALVE	8
DRAIN	8
ELECTRICAL SERVICE	9
ROOM CONTROLS	9
TEMPERATURE SENSOR	10
THERMOSTAT	10
I60 ROOM SWITCH	11
REFRESH SWITCH	11
WIRING DIAGRAM AI12-AI24	12
WIRING DIAGRAM AI30-AI48	13
STARTING THE GENERATOR	14
OPERATING INSTRUCTIONS	15
BOILER START	15
STEAM ROOM OPERATION	15
THE I60 SWITCH	16
THE REFRESH™ SWITCH	16
LIGHTS AND SWITCHES	16
ROUTINE MAINTENANCE	17
WATER LEVEL CONTROL	17
BLOWDOWN/ CoolFlush™ Auto Drain option	17
BLOWDOWN/MANUAL DRAIN	19
APPENDIX 1: RUN CLOCK AND AUTOBLOWDOWN CLOCK	20
APPENDIX 2: PRESSURE CONTROL ASSEMBLY	21
APPENDIX 3: LOW WATER CUTOFF INSTRUCTIONS	22

SAVE THIS MANUAL

A **MANUFACTURER'S REPORT: CONTROLS AND SAFETY DEVICES** is supplied with each generator. You may be required to present this form to a state, provincial or other inspection agency. **Secure this document in a safe location.**

Thank you for purchasing your new SAUNATEC steam generator.
If we can be of any assistance do not hesitate to call our Service Department at **1-800-363-0251**.

FOR THE SAFETY OF YOU AND YOUR FAMILY OR CUSTOMERS, PLEASE READ FOLLOWING WARNINGS AND ALL INSTRUCTIONS BEFORE USING YOUR STEAMBATH. POST "WARNING LABEL OUTSIDE STEAMBATH FOR SAFETY WARNINGS. REQUIRED POSTING ON DOOR OF STEAM ROOM OR ADJACENT TO DOOR FOR ALL COMMERCIAL INSTALLATIONS.



IMPORTANT SAFETY INSTRUCTIONS

1. READ AND FOLLOW ALL INSTRUCTIONS.
2. WARNING - To reduce the risk of injury, do not permit children to use this product unless they are closely supervised at all times.
3. WARNING - To reduce the risk of injury:
 - a. The wet surfaces of steam enclosures may be slippery. Use care when entering or leaving.
 - b. The steam head is hot. Do not touch the steam head and avoid the steam near the steam head.
 - c. Prolonged use of the steam system can raise excessively the internal human body temperature and impair the body's ability to regulate its internal temperature (hyperthermia). Limit your use of steam to 10 - 15 minutes until you are certain of your body's reaction.

d. Excessive temperatures have a high potential for causing fetal damage during the early months of pregnancy. Pregnant or possibly pregnant women should consult a physician regarding correct exposure.

e. Obese persons and persons with a history of heart disease, low or high blood pressure, circulatory system problems, or diabetes should consult a physician before using a steambath.

f. Persons using medication should consult a physician before using a steambath since some medication may induce drowsiness while other medications may affect heart rate, blood pressure and circulation.

4. **WARNING** - Hyperthermia occurs when the internal temperature of the body reaches a level several degrees above the normal body temperature of 98.6 degrees F. The symptoms of hyperthermia include an increase in the internal temperature of the body, dizziness, lethargy, drowsiness and fainting. The effect of hyperthermia include:

- a. Failure to perceive heat:
- b. Failure to recognize the need to exit the steambath:
- c. Unawareness of impending risk:
- d. Fetal damage in pregnant women:
- e. Physical inability to exit the steambath: and
- f. Unconsciousness.

WARNING - The use of alcohol, drugs or medication can greatly increase the risk of hyperthermia

SAVE THESE INSTRUCTIONS



WARNING



Electric Shock Hazard - High voltage exists within this equipment. Disconnect all electrical power before servicing the generator. All installation and service to this equipment should be performed by qualified licensed personnel in accordance with local and national codes. There are no user serviceable parts in this equipment.

Electrical grounding is required on all SAUNATEC steambath generators. The generator is designed for hookup with copper wire only, 75°C or better.

Wire the controls exactly as described. Do not connect any additional wiring or power supplies to the controls or their terminals in the generator.

All plumbing must be installed by a licensed plumber in accordance with all applicable local and national codes.

Install indoors only. Protect from freezing. Generator must be level side to side and end to end.

The pressure relief valve and generator drain must be installed in such a fashion that the risk of scalding is reduced to a minimum. Draining these outlets into the steam room may present a scald hazard and may damage materials used to construct the room.

Avoid traps and valleys in the steam line where water could collect and cause a steam blockage. The hot steam line must be insulated against user contact.

Be certain that steambath enclosures are properly sealed to avoid water damage from escaping steam. It is recommended that 100% silicone caulk be used to seal all pipes and fittings. Steam must be prevented from escaping into the wall cavity. Centering the steam pipe is critical in rooms made of plastic, acrylic, resin, fiberglass or similar materials. Allowing the steam pipe to touch materials not rated 240°F or higher will result in damage to these materials.

Do not install the steam head near bench(es) or where steam may spray or where condensation will drip on the user as this will present a scald hazard.

Be careful when entering a steambath. Escaping steam from an overheated steam room may cause injury.

Scald Hazard: Do Not Touch the steam head or trim during operation as they are HOT. Stay at least 12 inches away from the hot steam escaping from the steam head.

Children should only use the steambath under close adult supervision.

Do not exceed 30 minutes in a steambath. Excessive exposure can be harmful to your health. Excessive exposure can produce a rapid pulse, light-headedness, weakness or fainting. If you become uncomfortable or experience any of the above conditions exit the steambath immediately.

Steambaths can put undue stress on the body. Therefore a steambath should be used only under a doctor's direction if you:

**Are in generally poor health
Are under the care of a physician
Have circulatory problems
Have diabetes**

**Are pregnant
Have a heart condition
Have high blood pressure
Are using medication**

DO NOT use the steam bath if you are under the influence of drug or alcohol!

GENERAL INFORMATION: The AI Commercial Steam Generator is a low pressure heating boiler, UL/CUL Listed, built to NEC requirements and with an ASME "H" stamped certified and National Board registered pressure vessel.

The generator has all steel construction with powder coated finish on visible surfaces and stainless steel mounting feet to minimize the risk of corrosion. The mounting feet hold the generator one inch above the floor to allow cleaning the floor below it and to further prevent corrosion. This also allows the generator to sit directly on a combustible surface without additional protection. The feet extend beyond the sides of the generator chassis and have clearance holes to allow securing the generator in place using ¼" bolts.

AI Commercial Steam Generators are factory assembled and tested and ready to install. All generators are plumbed for a ½" potable water feed inlet, a ¾" drain discharge and a ¾" pressure relief valve discharge. Generators are available for connection to 208VAC or 240VAC single or three phase, or 480VAC in three phase only. All models require the appropriate full power electrical service plus ground. Models in 208V and 240V also require a 14 gauge minimum Neutral for the control circuit; 480V models require a separate 120VAC+N service for the control circuit. **Use 75° minimum copper wire for all service connections.** A ¾"-1"-1½"-2" combination knockout is provided in the generator's electrical box for the main service conduit and an additional ½"-¾" knockout is provided for the 480V models' 120V control service.

The generator's control circuit is protected by a 250VAC 3A non-time-delay fuse installed in the front panel of the generator's electrical box. A 100mA time-delay fuse mounted on the generator's circuit board protects the board's low voltage circuitry. No other fusing is installed in the steam generator.

Room controls (ON/OFF, thermostat, temperature sensing and steam Refresh™) are connected during generator installation using factory supplied wire or cables. Room controls operate on a low voltage Class 2 circuit. An access hole and knockouts, ½" trade size, are provided for room control wiring. The thermostat must be mounted outside the steam room, the temperature sensor must be mounted inside the steam room, the optional Refresh™ switch mounts inside the steam room, the optional I60 Bath On/Off switch is available for mounting outside the steam room. Temperature sensors require factory supplied cables for connection to the generator, all other controls require 3 conductors, 18 to 24 AWG copper, 75° 300V minimum (25 foot long cables are provided).

Standard equipment:

Manual operation (generator mounted RUN switch and manual ball valve drain) and single steam room (one steam valve, one temperature sensor, one thermostat with integral steam bath ON/OFF switch and bath-on indicator light, two steam heads). Switches allowing manual heat and water control during routine service, lights indicating heat and valve operating status and self-check fault codes.

Optional equipment:

Second steam room (second steam valve, thermostat and temperature sensor) **factory installed only!**
RUN CLOCK (7-day or 24 hour clock or 7-day programmable digital clock for generator ON/OFF scheduling).
CoolFlush™ Auto Drain (24 hour clock plus electronic drain valve).
Steam bath ON/OFF switch: commercial (mounts to single gang switch box in a dry location only, automatic timeout 60 minute bath time, integral bath-on indicator light).
Steam bath ON/OFF switch: residential (membrane switch, may be mounted in steam room, automatic timeout 60 minute bath time, integral bath-on indicator light).
Steam Refresh™ (membrane switch for mounting inside steam room, status indicator light).
Manual reset low water cut-off (check your local codes for requirements)

Water Quality Requirements:

The nature of a steambath generator requires testing of the feedwater to avoid potential high concentrations of impurities which can cause a deposit or scale to form on the internal surfaces. This deposit or scale can interfere with the equipments proper operation and even cause premature generator failure. Concentration of impurities is generally controlled by treating the feedwater and/or "blowing down" the generator when it is not heating. The "blow down" process involves removing a portion of the tank water with high solid concentration and replacing it with makeup water.

To reduce corrosion and element damage risks, always flush feedwater lines thoroughly to eliminate flux residue and avoid sodium based water softeners. The ASX-200 filter system available from Saunatec provides very good protection in most installations and should be connected to a cold water supply. *Feedwater temperature must be no hotter than 100°F if the ASX-200 is installed!*

To insure proper operation, the water supply should be tested prior to operating the equipment. There are several treatment processes which can be used if you have a problem with hard water. A local reliable water treatment company can recommend the appropriate treatment if required. The recommended feedwater quality is listed below.

Feedwater Quality

Hardness, ppm	10 – 30 (.5 – 1.75 gpg)
T-Alkalinity, ppm	150 – 700 (8.75 – 40.8 gpg)
Silica, ppm	15 – 25 (.875 – 1.45 gpg)
PH (strength of alkalinity)	10.5 – 11.5

IMPORTANT! Regular maintenance will help your steamer work properly for a long time. Check for leaks, loose or damaged wires, signs of corrosion and calcium build up in the tank and on the level probe.

This is particularly important in areas with high calcium levels and other water quality problems. Calcium buildup can cause poor steamer performance and damage the heating elements!

Some water filtration equipment is available through Saunatec. Contact us for further information.

For service or assistance contact
Saunatec Steam Service between 7:00am and 5:00pm Pacific time at
1-800-363-0251

SAUNTEC AI BOILER RATINGS

CATALOG#	UL MODEL#	WATTS	VOLTS	PHASE	AMPS	MAX ROOM SIZE (CU FT)	STEAM LB-HR	DIMENSIONS		
								L	W	H
AI 12	12-208	12,000	208	1	59	500	36	20	22	24 ½
	12-208		208	3	34					
	12-240		240	1	51					
	12-480		480	3	15					
AI 18	18-208	18,000	208	1	88	750	54	20	22	24 ½
	18-208		208	3	51					
	18-240		240	1	76					
	18-480		480	3	22					
AI 24	24-208	24,000	208	1	116	1000	73	20	22	24 ½
	24-208		208	3	68					
	24-240		240	1	101					
	24-480		480	3	29					
AI 30	30-208	30,000	208	3	85	1250	91	20	28	24 ½
	30-240		240	3	73					
	30-480		480	3	36					
AI 36	36-208	36,000	208	3	101	1500	109	20	28	24 ½
	36-240		240	3	88					
	36-480		480	3	43					
AI 42	42-208	42,000	208	3	118	1750	127	20	28	24 ½
	42-240		240	3	102					
	42-480		480	3	51					
AI 48	48-240	48,000	240	3	117	2000	145	20	28	24 ½
	48-480		480	3	58					

Notes:

All models: no internal heating circuit fuses are needed, panel mounted 3A fuse provided for 120V control circuit
All models use 120VAC control circuits.

208V and 240V models supply 120V to control circuit internally, 480V models require a separate 120V service.

- For 208V and 240V models, run power wires + Ground and a 14AWG Neutral for controls.
- For 480VAC units, run 3 power wires + Ground and run a 120V service for the 3A control circuit.

Use only copper wire, rated 75°C or better.

Install all wiring per local codes.

AI 12, 18, 24

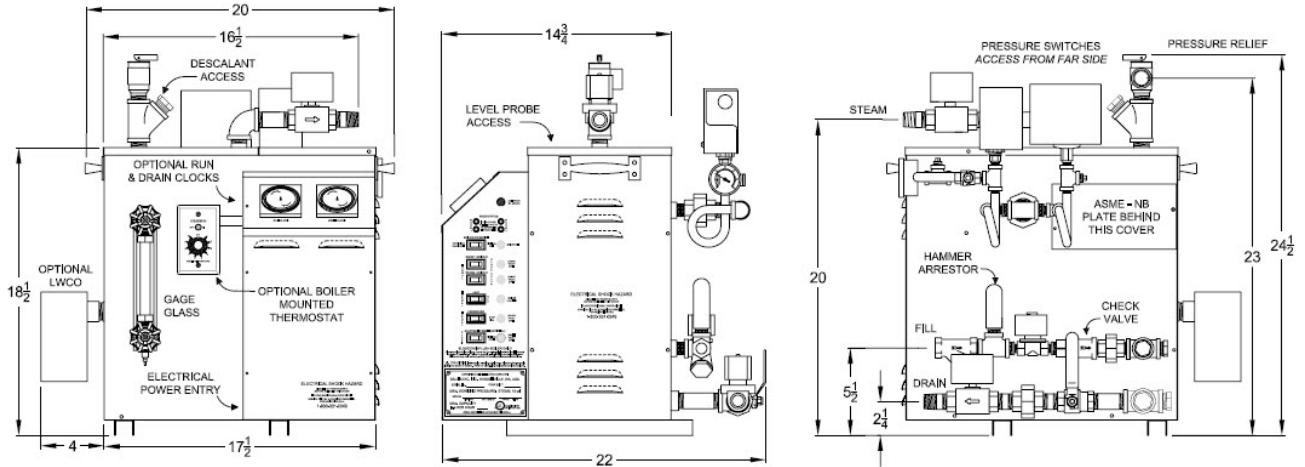

AI 30, 36, 42, 48

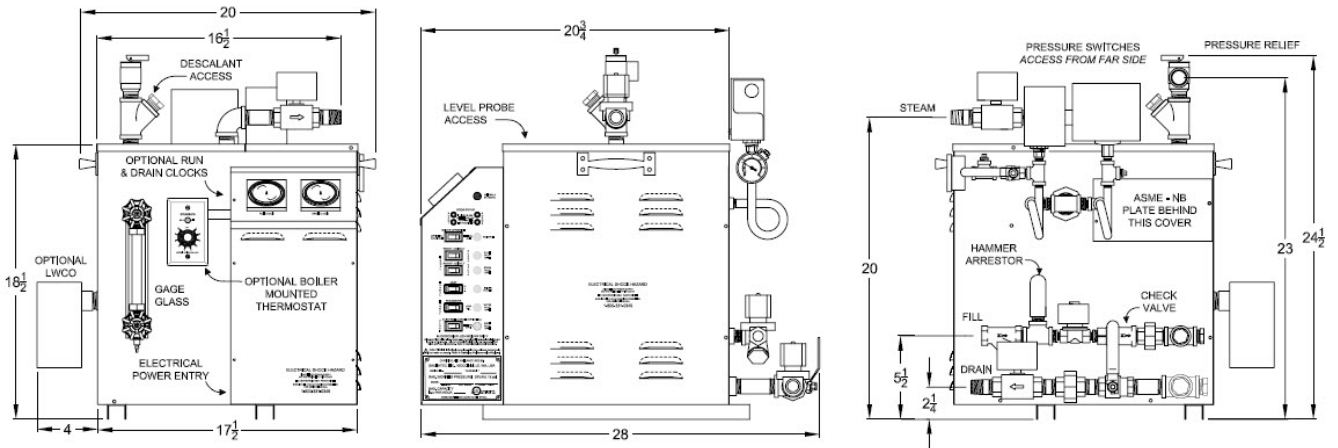

INSTALLATION

GENERATOR

AI Steam Generators must be installed by a licensed plumber and electrician to local and national codes.



**AI Steam Generators are intended for indoor use only.
Install upright and level side to side and front to back.
Not for space heating purposes.
Protect from freezing.**

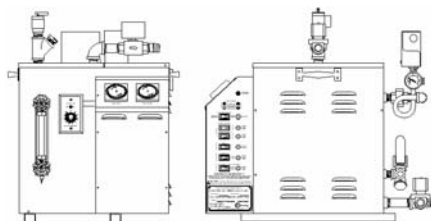

The steam generator is designed to sit directly on a hard level surface. The mounting location must be suitable to safely support over 125lb.s for models AI12-AI24 and over 150lb.s for AI30-AI48. The generator must be mounted upright and level and prevented from moving. *Ensure that the generator is mounted high enough above the drain receptacle to allow proper drain flow.* The weight of the generator is generally sufficient to prevent movement. Use 1/4" bolts through the holes provided in the generator's feet to secure it in place on the floor if necessary.

The generator's back end (nearest the water gauge) may be installed 1" or further from a wall or combustible surface. Use the lift handle to set the minimum clearance by placing the generator so the handle just touches the adjacent surface. Keep combustibles at least 1" away from left side, 8" from right side plumbing and 6" from top of switches and steam valve. Do not store solvents, paints or other flammables near the generator.

All electrical access is from the left side and front end (as viewed at right). Up to 480VAC may be exposed during servicing. Leave space for service access: at least 18" to front and left side, 6" above the pressure switches and valves.

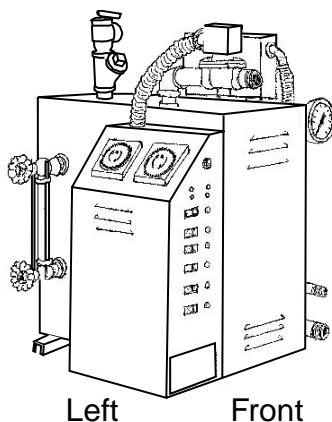

Install per code: *your local codes may require even greater clearances.*

Leave sufficient space between the right (plumbing) side and adjacent surfaces to allow servicing the plumbing when needed. Provide at least 8" clearance from the piping for access.

CAUTION: *Exposed plumbing may be over 200°F during normal operation and can present a severe burn hazard. Be sure to protect people from accidental contact!*

PLUMBING *All valves are factory equipped with a short pipe nipple in their outlet. When attaching plumbing, hold these nipples while tightening. Do not tighten plumbing by using a wrench on the brass valve bodies as this can damage the valve! Brass or copper lines are recommended for all plumbing.*

1. INSTALL WATER LINE

Run a 1/2" potable water feed line between the nearest cold water line and the WATER INLET fitting on the generator. Cold feedwater is required for proper operation of the CoolFlush™ Auto Drain system. *Special water treatment may be required in your area – see Water Quality section on pages 6 and 7 for further details.* Install a shut-off valve near the generator. When tightening the water fittings, always use two wrenches so there will be no strain on the water inlet valve. The water shut off valve must remain open during generator operation! We recommend feedwater pressure between 20 and 50 psi. A water hammer prevention device is installed on your boiler. *Excessive water hammer can damage a water valve, preventing it from shutting off the water supply to the generator!*

Flush water supply line thoroughly before final hookup. *Debris such as flux residue can prevent the inlet valve from fully closing and may cause corrosion damage to the water valve or heating elements.* A grit filter is factory installed on the generator to trap large debris such as sand. Shut the water supply off and remove and clean the filter periodically as dictated by local water conditions.

A check valve is installed in the boiler's feedwater line. An additional customer supplied back-flow prevention device may be required in your area. **Check local codes.** *To prevent water level sensing errors, backflow*

prevention is necessary in installations where the steam generator's water supply is shared with another generator or other nearby high usage connection.

2. INSTALL STEAM LINE

AI generators come equipped with $\frac{3}{4}$ " NPT steam outlets. *Do not place a shutoff device in the steam line! Locate steam heads so bathers do not come into contact with a steam head and so steam may not exhaust directly on any part of a bather's body. Steam and steam heads are very hot and can cause severe burns!*

Run a $\frac{3}{4}$ " copper steam line from the generator to the steam room. The steam line should enter the steam room 18" above the floor.

IMPORTANT: the steam line should be pitched away from the generator so any condensate will drain from the steam line. For best results, the generator should be installed as close to the steam room as possible, with its steam outlet valve higher than the steam heads in the steam room and the steam line run straight to the steam heads with a pitch of at least $\frac{1}{4}$ " per foot to drain into the room. Do not allow sags, dips or other low sections in the steam line: these may block the steam flow or cause spitting of very hot water into the steam room.

As with any steam bath steam generator, spitting, reduced steam and other problems can occur if too many elbows or tees are placed in the steam line, if the line is too long, if the line has large rises or if there are low area or traps in the line. The effects depend on the number and size of these practices in a particular installation.

To reduce noise or improve the distribution of steam in larger rooms, additional steam heads may be installed. Two steam heads are supplied with each generator. Space steam heads at 6" intervals, minimum. If steam heads must be mounted one above another, use 12" spacing, minimum. *The steam heads should be located to ensure they do not discharge steam or drip condensate where the user may come in contact with the hot moisture – contact may cause injuries from scalding to severe burns!*

At the steam room: drill/prepare a $1\frac{3}{8}$ " hole at each steam head location for steam line entry 18" above the floor. Terminate the steam line from the generator with a tee at the steam room then plumb each side of the tee to a steam head location and through the wall. Center the $\frac{3}{4}$ " copper steam pipe in the $1\frac{3}{8}$ " hole. Terminate the steam line with a $\frac{3}{4}$ " NPT male adapter. Stub the line out into the room $\frac{7}{8}$ " from the finished surface. Secure the steam lines to structural members.

Install steam heads so vent opening is pointed towards the floor. Use Teflon thread tape to help aim the steam head correctly if necessary. Protect the steam head finish from damage while handling and tightening. Seal the wall around the steam pipes and all fixtures in the steam room with 100% silicone caulk to avoid moisture damage within the walls.

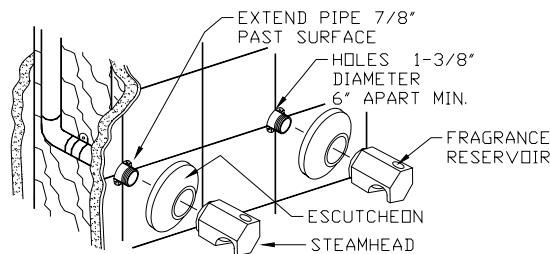

IMPORTANT If the steam line is in an area where the temperature will be below 40°F or if the line is more than 20 feet long, best results can be obtained by insulating the steam pipe. Any insulation must be suitable for temperatures of at least 250°F.

3. INSTALL SAFETY VALVE LINE All AI generators are equipped with a factory installed 15 psi pressure relief safety valve. This must be plumbed to a $\frac{3}{4}$ " indirect waste line. *Do not install a shut off device in this line. Do not reduce this line. Do not form a trap in this line! Discharge from the safety valve may be at over 240°F. Do not plumb this line into the steam room! Plumb this waste line per local plumbing codes.*

4. INSTALL DRAIN All AI generators are equipped with a factory installed manual ball valve to allow draining the tank. An optional electronic drain may be installed after the manual valve. Plumb the drain to a $\frac{3}{4}$ " indirect waste line. *If the drain is opened while the generator is under pressure, discharge from the drain may be at over 240°F. Always plumb the drain with piping suitable for 240°F minimum. Do not plumb this line into the steam room! Plumb this waste line per local plumbing codes.* When equipped with a drain system and with the pressure control properly set to 4 to 5psi, drain water will be at or below 140°F during the CoolFlush™ Auto Drain cycle. *Local codes may require a (customer supplied) expansion tank or blowdown cooling tank if draining water in excess of 140°F or 5 psi.*

ELECTRICAL

Refer to the ID plate on the generator's switch panel to determine voltage and current requirements. Electrical service for all models requires two (single phase) or three (3 phase) hot leads plus a suitable ground connection. Models operating on 208V or 240V also require a 14 AWG Neutral for the generator controls circuit. Models operating on 480V require a separate 120V (14AWG) service for the controls circuit. Route the copper supply wire with appropriate strain relief through the hole marked POWER ENTRIES. A multiple knockout is provided at this point for electrical service using up to 2" conduit. A second knockout, 1/2" to 3/4", is provided for the 120V controls circuit, if needed.

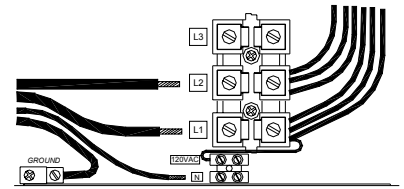

1-Phase Power

Connect the control circuit's Neutral (208/240V models) or 120V+N (480V models) to the left side of the small terminal block provided in the generator's electrical enclosure. Connect the power service to the generator's large terminal block and the ground to the generator's ground lug, located near the front edge of the electrical enclosure (a copper wire clamping lug with green screw). Ensure all wires are tightly clamped at their respective terminals.

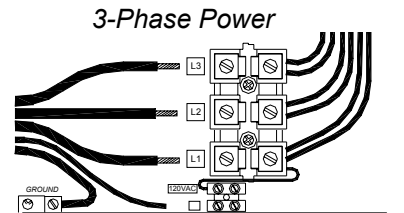

3-Phase Power

CAUTION: Loose wire connections can cause heat damage to wires, terminal blocks and other components and may void the warranty.

NOTE: A GFCI device is not required by UL. A GFCI may be installed if required by local codes or the owner. A GFI device will tend to nuisance trip due to heater element aging.

ROOM CONTROLS

Each steam valve outlet is to be used for a single steam room. Each room requires one temperature sensor mounted in the room and one thermostat control mounted outside the room. The thermostat mounts to a standard single switch/outlet electrical box. The thermostat may be mounted directly on the generator's electrical enclosure using a common 1/2" conduit z-bracket between the box and a knockout provided in the generator's electrical enclosure. To reduce the risk of electrical interference between circuits, do not run the low voltage control cables inside the same conduit as high voltage circuits. Avoid running control cables closely alongside high voltage wiring in cable troughs and raceways.

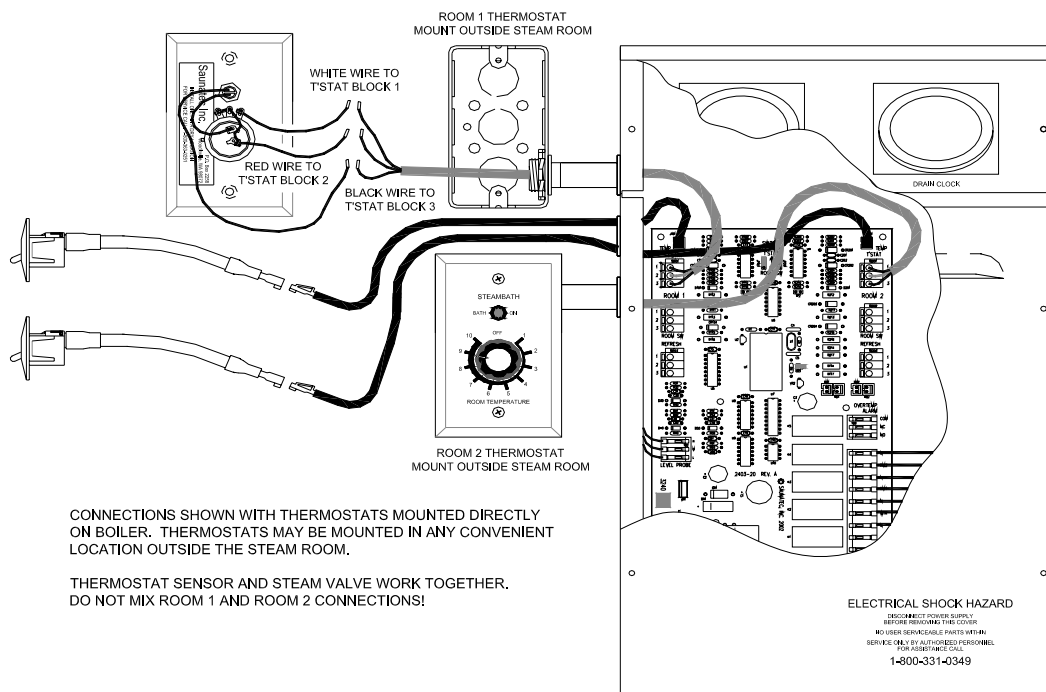

Two independent control circuits are available for two steam outlets to supply two separate steam rooms. If only one valve is installed on the steam generator, it will be controlled by the ROOM 1 circuit with controls connected to the terminal blocks alongside the left edge of the printed circuit board (PCA) located in the generator's electrical enclosure. When the (optional) second outlet is provided, the second room's controls connect in the same manner as the ROOM 1 circuit's described here. *Follow all wiring and PCA jumper setting instructions closely for proper operation.*

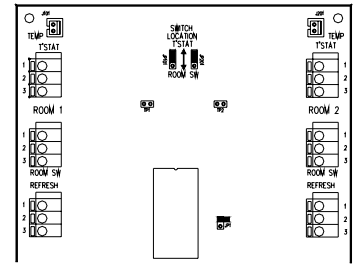

1. TEMPERATURE SENSOR INSTALLATION The temperature sensor must be mounted in the steam room. Cut a 7/8" diameter hole in the steam room wall to mount the sensor. It is recommended that the sensor be mounted 6" down from the ceiling, but not directly over the steam dispersion head and not more than 7 feet above the floor. *Do not cover or enclose the sensor: if the airflow across the sensor is blocked or reduced, the room may overheat or suffer large temperature variations.*

String the sensor cable from the sensor location through 1/2" holes in the wall studs or ceiling joists to the generator location. Leave 12" of slack at the sensor location. Route the generator end of the sensor cable through the generator hole marked CONTROL WIRING ENTRY using the strain relief provided.

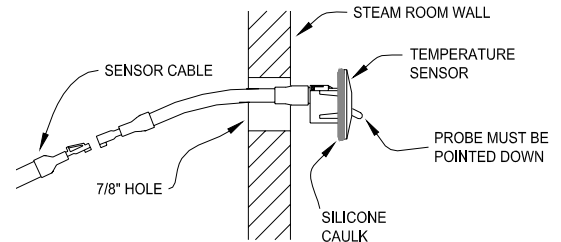

Note: Do not staple through or otherwise damage the cable. Use a factory supplied sensor cable only.

In the steam room: Plug the temperature sensor into the sensor cable. The cable and the sensor connectors are designed to lock together when properly aligned. Run a bead of 100% silicone caulk around the underside of the sensor head then carefully feed the cable and sensor through the hole and attach the sensor in place.

At the generator: Connect the sensor cable's end plug into its socket on the generator's control circuit board. The socket is directly above the room's T'STAT terminal block. Orient the cable end to match its socket and insert it until the end locks in place. Make sure the thermostat and temperature sensor cables are connected at the same side of the circuit board: either along the left edge (ROOM 1) or the right (ROOM2). *When only one steam outlet valve is available, always connect to ROOM 1.*

2. THERMOSTAT INSTALLATION The low voltage thermostat control can be mounted up to 50 feet from the generator and must be located outside the steam room. A 25 foot cable is provided. String the 25' cable from the control location through 1/2" holes in the wall studs or ceiling joists to the generator and the switch box installed at the desired control mounting location.

At the control: Connect the control cable to the thermostat control using wire nuts (provided). Match the provided cable's red and black wires to the thermostat's red and black wires, respectively. Match the cable's third wire (white or green) to the thermostat's white wire.

At the generator: Route the generator end of the control cable through the generator hole marked CONTROL WIRING ENTRIES using the strain relief provided. Strip the control cable wire ends 1/2" and place the bare copper into the ROOM 1 (or ROOM 2) T'STAT terminal block, putting the black wire in the bottom hole ("3"), red in the center ("2") and white (or green) in the top ("1"). Use a small screwdriver to carefully press the terminal block's orange tabs down to insert or remove the wire ends. *When only one steam outlet valve is available, always connect to ROOM 1.*

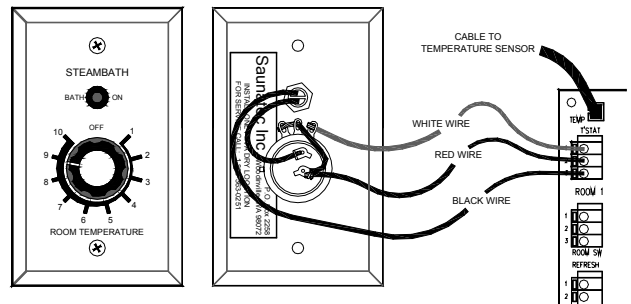

The thermostat has an integral switch to start and stop the heating of the steam room: *see operating instructions.* If an (optional) I60 switch or other switch is to be used, it will connect to the ROOM SW terminal block as described in the following section. When using the thermostat as the Bath on/off switch, place a jumper on only one pin of JP1 (near the center of the PCA).



The SWITCH LOCATION jumpers at the top center of the PCA must be correctly set to correspond to the switch used. If only the thermostat will be connected place the jumper on the center and top pins. If another switch will be connected to the ROOM SW terminal block, set the place on the center and bottom pins:

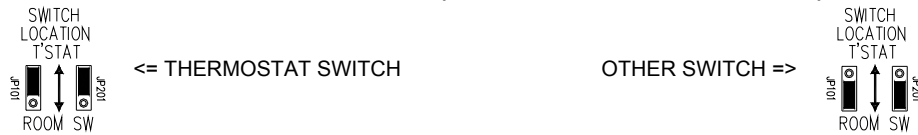

3. I60 ROOM SWITCH INSTALLATION The I60 switch is a momentary type switch (closed only while pressed) intended for installations with occasional use. When an I60 switch or equivalent is connected, the JP1 jumper must be correctly set as shown below. The steam bath will start when the switch is pressed and stop automatically 60 minutes later or when the switch is pressed again. **If the optional second steam room is installed, both rooms must use the same type of switch, either the thermostat or the I60!**

When using an I60 switch, place a jumper on both pins of JP1 (near the center of the PCA) and place JP1 the jumpers on the SWITCH LOCATION center and bottom pins as described above.

The (optional) I60 switch provides a low voltage control which may be mounted up to 50 feet from the generator and must be located outside the steam room. A 25 foot cable is provided. String the 25' cable from the control location through 1/2" holes in the wall studs or ceiling joists to the generator and the switch box installed at the desired control mounting location. *The switch location jumpers must be correctly set for proper operation.*

At the control: Connect the control cable to the switch using wire nuts (provided). Match the provided cable's red and black wires to the switch's red and black wires, respectively. Match the cable's third wire (white or green) to the switch's white wire.

At the generator: Route the generator end of the switch cable through the generator hole marked CONTROL WIRING ENTRY using the strain relief provided. Strip the control cable wire ends 1/2" and place the bare copper into the ROOM 1 (or ROOM 2) ROOM SW terminal block, putting the black wire in the bottom hole ("3"), red in the center ("2") and white (or green) in the top ("1"). Use a small screwdriver to carefully press the terminal block's orange tabs down to insert or remove the wire ends. *When only one steam outlet valve is available, always connect to ROOM 1.*

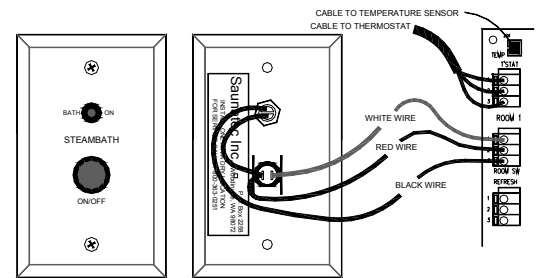

4. REFRESH SWITCH INSTALLATION The (optional) Refresh™ switch uses a low voltage control to provide a short burst of steam in the steam room when the switch is pressed. The switch may be mounted up to 50 feet from the generator and must be located inside the steam room. A 25 foot cable is provided. String the 25' cable from the control location through 1/2" holes in the wall studs or ceiling joists to the generator and the desired control mounting location in the steam room.

At the control: Connect the control cable to the switch terminal block on the Refresh™ switch. Connect the switch cable to the switch and note which wire is connected to which terminal block position. An instruction plate is provided and should be attached to the wall alongside the Refresh™ switch in the steam room to help bathers understand the Refresh™ operation. The instruction plate is adhesive backed for easy mounting to a clean dry surface.

USE THIS SWITCH TO REFRESH THE STEAM AFTER SUDDEN COOLING
WHEN THE SWITCH'S GREEN LIGHT IS ON, PRESS AND RELEASE THE SWITCH BUTTON. THE LIGHT WILL TURN OFF AND STEAM WILL BE ADDED TO THE ROOM FOR 10 TO 15 SEC. TWO MINUTES AFTER PRESSING THE SWITCH THE LIGHT WILL TURN ON AGAIN AND THE SWITCH WILL BE READY FOR ANOTHER BURST OF STEAM WHEN NEEDED.

At the generator: route the generator end of the switch cable through the generator hole marked CONTROL WIRING ENTRIES using the strain relief provided. Strip the switch cable wire ends 1/2" and place the bare copper into the ROOM 1 (or ROOM 2) REFRESH terminal block, matching the colors to the terminal block positions identically to the switch's connections. When finished, the switch's block position 1 should be connected to the PCA's position 1, 2 to 2 and 3 to 3. Use a small screwdriver to carefully press the terminal block's orange tabs down to insert or remove the wire ends. *When only one steam outlet valve is available, always connect to ROOM 1.*

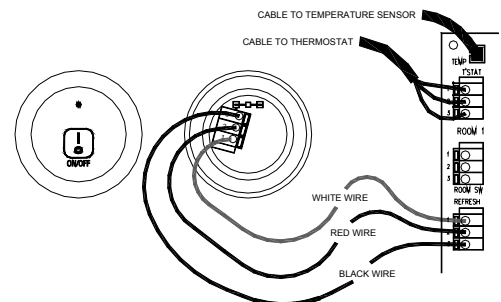

WIRING: AI 12, AI 18 and AI 24

ALL WIRING MUST BE INSTALLED BY A LICENSED ELECTRICAL CONTRACTOR IN ACCORDANCE WITH ALL APPLICABLE LOCAL AND NATIONAL CODES.

ELECTRICAL GROUND REQUIRED ON ALL STEAMERS.

ELECTRIC SHOCK HAZARD – HIGH VOLTAGE EXISTS WITHIN THIS EQUIPMENT. THERE ARE NO USER SERVICEABLE PARTS IN THIS EQUIPMENT.



DISCONNECT ALL ELECTRICAL SUPPLIES WHEN SERVICING THIS EQUIPMENT; 480V GENERATORS HAVE TWO SEPARATE SUPPLIES.

Notes:

Jumper factory installed between field wiring terminal blocks to pick off 120VAC for control circuit. Jumper is not installed for 480V models. Separate 120V+N service required for 480V models.

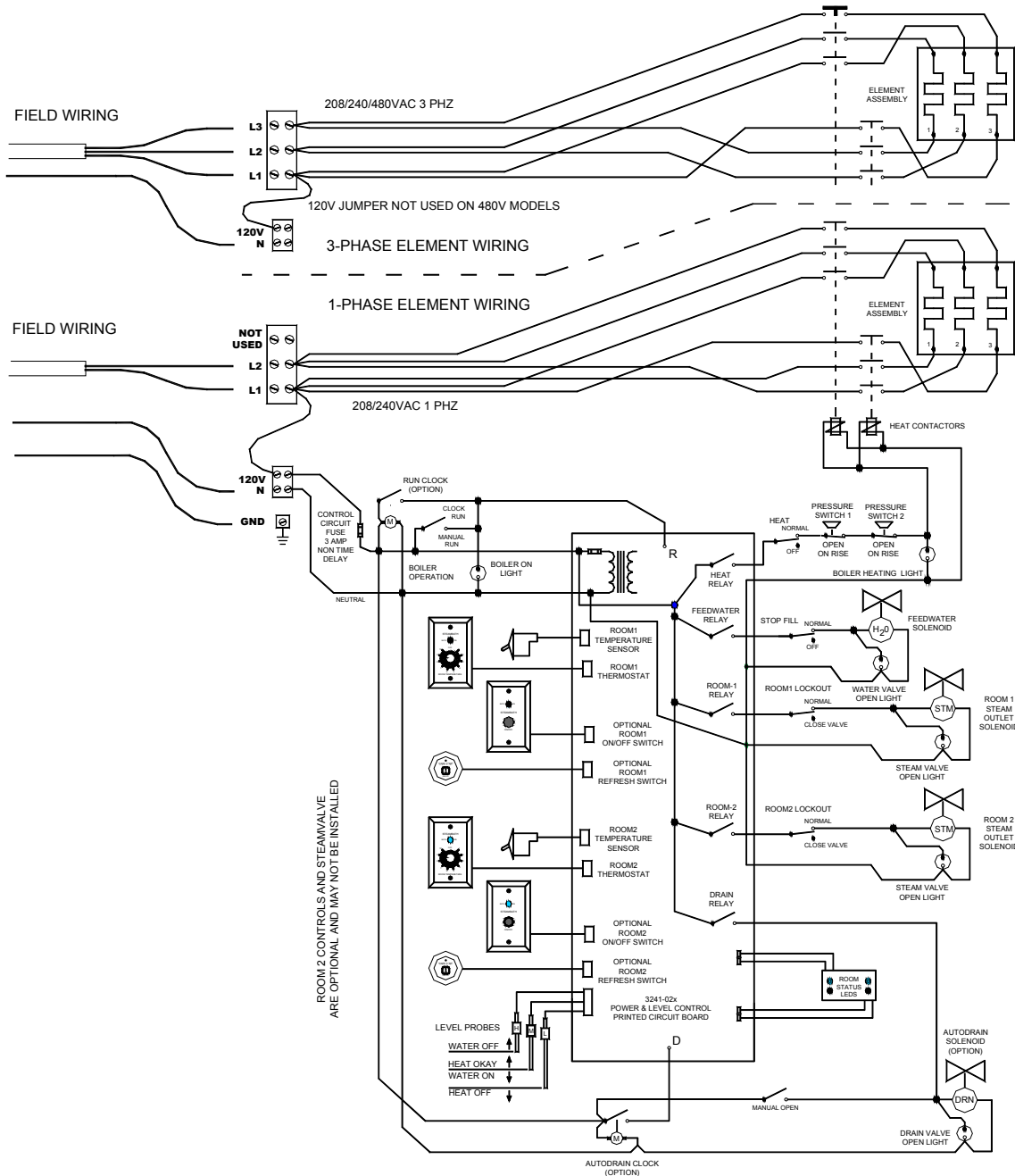

WIRING: AI 30, AI 36, AI 42 and AI 48

ALL WIRING MUST BE INSTALLED BY A LICENSED ELECTRICAL CONTRACTOR IN ACCORDANCE WITH ALL APPLICABLE LOCAL AND NATIONAL CODES.

ELECTRICAL GROUND REQUIRED ON ALL STEAMERS.

ELECTRIC SHOCK HAZARD – HIGH VOLTAGE EXISTS WITHIN THIS EQUIPMENT. THERE ARE NO USER SERVICEABLE PARTS IN THIS EQUIPMENT.

DISCONNECT ALL ELECTRICAL SUPPLIES WHEN SERVICING THIS EQUIPMENT; 480V GENERATORS HAVE TWO SEPARATE SUPPLIES.

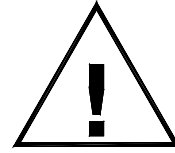

Notes:

Jumper factory installed between field wiring terminal blocks to pick off 120VAC for control circuit. Jumper is not installed for 480V models. Separate 120V+N service required for 480V models.

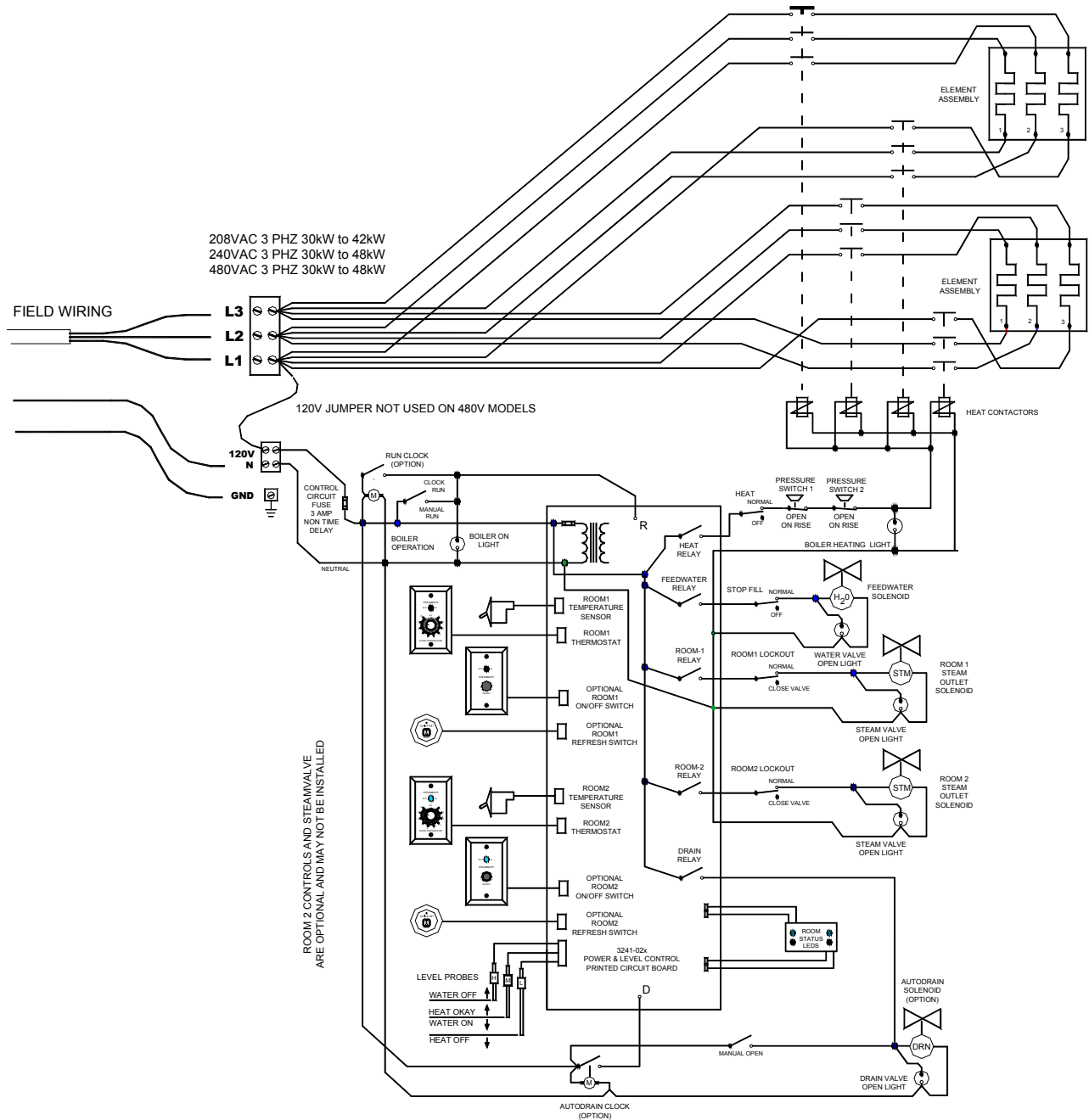

STARTING THE GENERATOR FOR THE FIRST TIME

Before applying power to the generator for the first time: On the electrical box's front panel set all rocker switches to the left, their normal operating position. If installed, set the optional Run Clock so the generator is off (no orange showing in area above pointer) and make sure the water supply is connected to the generator and turned on.

Open the valves on the glass water gauge all the way (counterclockwise).

Open the pressure gauge valve (handle horizontal).

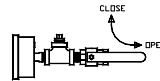

or

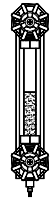
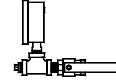

If the CoolFlush™ Auto Drain option is not installed, close the manual drain ball (handle up).

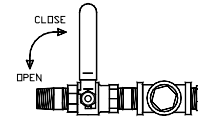

If the optional electronic CoolFlush™ Auto Drain is installed, open the manual drain ball valve as shown (handle pointing towards electronic valve). Set the Drain Clock to an off position (no orange showing in area above pointer).

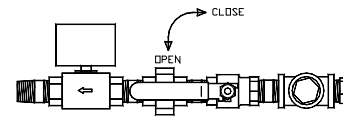

Set the room thermostat(s) to the **OFF** position.

Turn on the electrical service to the boiler. *All lights and valves should be off at this point.*

Set the **BOILER OPERATION** switch to the right (red showing) or set the optional run clock to a "RUN" position (orange area above the pointer). The **BOILER ON** light, both room **STEAM VALVE OPEN** lights and the **WATER VALVE OPEN** light should turn on and the boiler will start filling with water. The water will become visible in the water gauge a short time later. When the maximum water level is reached, the feedwater valve and its light will turn off, the steam valve lights will turn off, the **BOILER HEATING** light will turn on and the heating element contactors will close. The boiler will continue heating until it reaches its operating pressure of approx. 4 to 5 psi, then the **BOILER HEATING** light and the contactors will turn off. *The first time the generator fills after power is supplied, it will fill to the maximum level then drain to just below maximum as part of its level testing. During normal operation, the water level should always be visible in the lower half of the gauge glass.*

Check for steam and water leaks. Repair any leaks before continuing.

NOTE: *When the boiler is started with an empty tank, the room steam valves will open to release the air pressure created during water fill. Once the tank has filled, the valves will operate normally, opening only when steam needs to be released to a room to increase its temperature. Also, whenever a steam valve opens to release steam to a room, the boiler heating is disabled for a few seconds. This is designed to increase the elements' working life.*

Turn the thermostat(s) on to begin heating the steam room(s). If an (optional) I60 room switch is installed, set the thermostat to the desired temperature and press the I60 switch to start the steam bath and begin heating the room. The status LEDs on the thermostat(s), switches and boiler will light and remain on continuously when the steam bath is on and operating normally.

OPERATING INSTRUCTIONS The AI model steam generators are based on two operating systems. The first is the generator itself, maintaining water levels and boiling the water to create steam for use in a steam bath. The second is the steam room control circuit, maintaining a comfortable steam bath by releasing steam from the generator only when needed to raise the temperature in the steam room. The generator's control circuit board is used for both systems so the generator must be running before starting a steam bath. And the generator may run continuously without affecting the steam room temperature. In this way the generator can be left running so it is ready to produce steam immediately when the thermostat (or optional I60 room switch) is used to start a steam bath.

BOILER START The generator operation may be started in one of two ways.

1. To start the generator manually, place the **BOILER OPERATION** switch (located on the generator's switch panel) to its **MANUAL RUN** position. The switch will show a red color at its left side to indicate that it has been turned on and the **BOILER ON** light will turn on to show the generator is running. If an optional Run Clock is installed, this manual switch will start the generator regardless of the clock setting and the generator will continue to run until the switch is returned to the **CLOCK RUN** position.
2. To start the generator using the optional Run Clock, leave the **BOILER OPERATION** switch in its **CLOCK RUN** position. Program the Run Clock to the desired on (RUN) and off periods. To determine if the clock is switching properly, rotate the dial to the right: when an on period is reached the **BOILER ON** light will turn on and the generator will fill and heat as necessary. Continue rotating the clock dial until the clock is reset to the current time. Check the Run Clock dial later in the day to ensure it is maintaining time correctly.

Normal generator operation controls water fill and heating using three water levels. The lowest level serves as a low water cut-off safety level: if the water level drops too far the heating elements are turned off to prevent damage. When the water level is near the bottom of the water gauge glass, there is enough water in the tank to allow heating it safely. When the water level reaches near mid-glass, the water level has reached its maximum depth and the water valve will close until the level drops to near the bottom of the glass again.

Water heating is controlled by the operating pressure switch. While there is enough water in the tank to allow heating, the elements will be energized if the pressure in the tank is below the switch setting (about 3 psi) and the water will be heated until enough steam pressure is generated to build up pressure in the tank to about 5 psi. At this point the elements are turned off until the pressure drops again.

If the steam bath is not turned on, no steam will be released to the room and the generator will need to boil the water only to make up for temperature loss from the generator itself. During a steam bath, particularly during initial heating, the generator may need to heat continuously to compensate for the steam being released to the steam room. The generator may not build up any pressure during this period.

When the generator is started with an empty tank, the steam outlet valve(s) will open to release air pressure created by adding water. If not released, this air pressure could be sensed by the pressure switch, preventing heating. The heat will turn on, the water valve will close and, if the steam bath is not turned on, the steam valve(s) will close when the water reaches its maximum depth.

STEAM ROOM OPERATION The steam room begins heating when the thermostat or room switch is used to "turn on" the steam bath. While the steam bath is on, steam is released to the room as needed to bring the temperature up to the thermostat setting. *When the generator supplies two rooms, the room operations are identical but independent. Only one room will be described here.*

The thermostat sets the room temperature using a 1 to 10 scale, with 1 being the coolest at about 90°F and 10 the hottest at about 124°F. These are the steam room temperatures sensed by the temperature sensor near the ceiling. **For bather safety and to prevent damage to the steam room, never attempt to force these temperatures higher!**

The thermostat has an OFF position to turn the steam bath off (prevent heating) if an I60 switch option is not installed. When the bath is turned off, the generator's steam valve will remain closed and the thermostat LED, the Refresh™ switch's LED and the corresponding **ROOM**

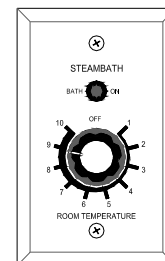

STATUS LEDs on the generator will remain turned off. When the thermostat is turned to the temperature setting part of the dial, the steam bath is turned on and all of the corresponding LEDs will light.

For the steam bath to be on whenever the generator is running, leave the thermostat set to the desired temperature setting. A few seconds after the generator is started, the room's LEDs will light and it will begin heating as soon as steam is available. *Do not install an I60 option when using continuous operation. Verify the JP1 jumper is on only one pin – refer to the Room Switch Installation section for details.*

THE I60 SWITCH option is intended for steam rooms with only intermittent use. When the I60 is installed, the thermostat's off position is the same as the lowest temperature setting and has no effect on the generator operation. The generator runs, holding steam under pressure until the user is ready to start a steam bath. The thermostat should be left preset to the desired room temperature. Press the I60 to start the steam bath. The room's LEDs will light once the bath is started. To stop the steam bath, press the I60 switch again or wait and it will turn off automatically 60 minutes after it was started. *If the generator supplies two rooms, both must use the same type of switch: if one uses an I60 switch the other must as well. Verify the JP1 jumper is on both pins – refer to the Room Switch Installation section for details.*

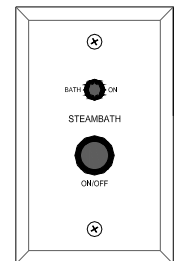

THE REFRESH™ SWITCH option gives the bather a more immediate control over the steam bath conditions. By pressing the Refresh™ switch during a steam bath, an extra burst of steam is added to the room regardless of the steam room temperature. This may be used to compensate for sudden cooling caused by someone opening the steam room door, for instance. An LED on the Refresh™ switch lights to indicate that the steam bath is turned on and an extra burst of steam is available. Once the switch is pressed, the switch's LED turns off and steam is released to the room for about 10 seconds. The extra steam released to the room adds a little heat and steam to “refresh” the steam cloud and stir the room's air, helping to reduce cold spots. There is a 2 minute delay after the Refresh™ switch is pressed before its LED turns on again and another steam burst is available. This wait period is designed to prevent a bather from accidentally overheating the room. Generally, if the room has cooled enough to need a second Refresh™ burst it will have cooled enough to require normal heating, too.

LIGHTS AND SWITCHES are provided to show generator operating status, to indicate fault conditions and to allow manual control of generator functions for routine maintenance and troubleshooting. During normal steam bath operation, the **ROOM STATUS** LEDs on the generator will light steadily. When the optional Refresh™ switch is installed, the bottom room status LED will turn off for two minutes while Refresh™ is in use. These LEDs will blink in specific patterns to indicate problems with the steam bath temperature control or generator water level control.

When the generator is operating normally, the **BOILER ON** light will be lit. All switches will be set to the left except the **BOILER OPERATION** switch will be set to MANUAL RUN (unless an optional Run Clock is installed).

The generator's **STEAM VALVE OPEN** lights will turn on when steam is released to heat the corresponding steam room. *Set a room's ROOM LOCKOUT switch to the CLOSE VALVE position to prevent steam being released to that room during servicing, room cleaning, etc.*

Whenever the generator is operating, the contactors will close as needed to turn on the heating elements, heating the generator's water and creating steam. The **BOILER HEATING** light turns on when the elements are turned on. *Place the HEAT switch in the OFF position to prevent heating, such as during manual drain/blowdown. NOTE: whenever a steam valve opens to release steam to a room, the boiler heating is disabled for a few seconds. This is designed to increase the elements' working life.*

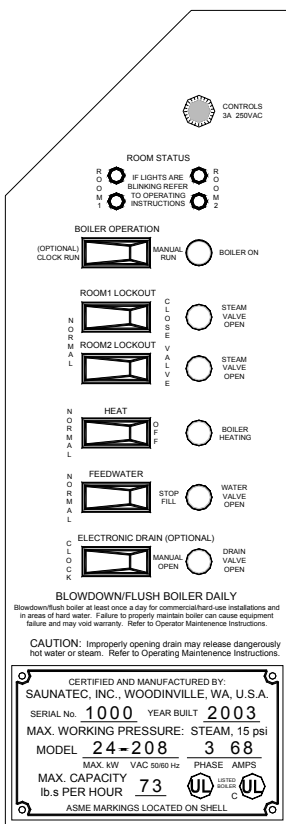

When the feedwater valve opens to refill the generator, the **WATER VALVE OPEN** light will turn on. *Set the **FEEDWATER** switch to STOP FILL to prevent water fill, such as during manual drain/blowdown.*

The optional electronic Auto Drain valve is normally closed, opening only when power is supplied by a Drain Clock or by the **ELECTRONIC DRAIN** switch to start drain/blowdown. When the Auto Drain valve is opened, the **DRAIN VALVE OPEN** light will turn on. Normal operation is controlled by a clock: Use the **ELECTRONIC DRAIN** switch to open the drain without resetting the clock. *This switch has no effect when the electronic drain valve is not installed. The manual drain ball valve must be left in the open position for the electronic Auto Drain to function.* There is a delay between seeing the DRAIN light turn on and the drain valve opening. This delay could be a minute or more.

ROUTINE MAINTENANCE The generator and controls should require very little maintenance. We recommend checking water level control periodically and frequent draining of the tank to ensure continued safe operation. Check for smooth, rapid flow when filling or draining the generator. Also look at the generator frequently to check for leaks and periodically check for loose or overheated wires and for indications of corrosion.

WATER LEVEL CONTROL Your local code may require a low water cut-off test at certain intervals. This is a good idea whether or not it is required. We recommend checking water level controls at least monthly. **CAUTION** *A hot generator can result in very hot water and steam being released to the drain and the operator may be exposed to dangerously high temperatures on fittings, valves and pipes. This test may be done while the generator is cold.*

To check the water level control circuit, first start the generator using the **BOILER OPERATION** switch.

Set the **HEAT** switch OFF. Turn on the steam bath and verify the room's steam valve is open (this will help the generator drain more quickly in the following steps). Adjust the thermostat as needed to open the steam valve.

Check the water level showing in the gauge glass: when the level rises above the middle of the glass, the water valve should close and stop filling the generator.

Open the generator's drain and reset the **HEAT** switch to its NORMAL position: the **BOILER HEATING** light will turn on and the heating contactors will close.

Watch the water level in the gauge glass: as the level reaches a depth of about 1/3 of the glass, the water valve will turn on again.

Set the **FEEDWATER** switch to STOP FILL and the water valve will close. Allow the water to continue to drain and watch the level in the glass. When the water level drops to about 1/2" depth in the glass, the **BOILER HEATING** light will turn off and the heat contactor will open. *This is the low water cut-off level.*

Set the **BOILER OPERATION** switch to off, close the drain and reset all switches to their NORMAL position. Reset the thermostat to its original position. The generator is now ready for normal operation again.

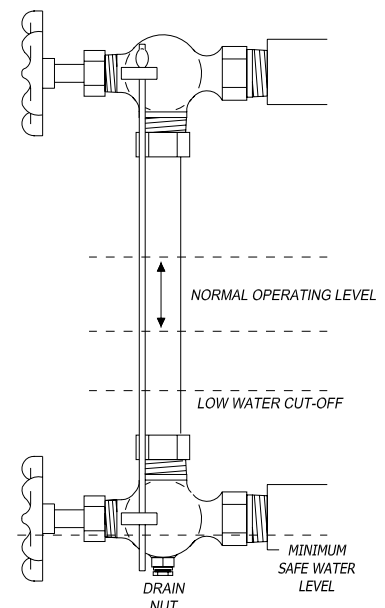

BLOWDOWN/ CoolFlush™ Auto Drain The generator is supplied with a manual drain valve and may be equipped with an (optional) electronic Auto Drain valve. An Auto Drain valve is always a good idea to easily schedule frequent draining. Rinsing or other cleaning of the tank is a manual operation. Draining the tank, particularly while under pressure, is often referred to as "blowdown." To avoid confusion, we will refer to emptying the generator's tank as "draining" here.

When water is changed to steam, solids may be left behind, eventually interfering with the water level sensing and possibly causing premature element failure. Frequent draining and periodic cleaning of the tank is necessary to help reduce the build-up of these solids (scale and sludge). *Every installation is unique in its water quality and maintenance requirements.* Symptoms of excessive build up include faulty water level sensing, gauge glass stained or water level not changing, plugged/slow running drains and early element failure. Draining the boiler tank at least once a day is recommended even with good water, much more often could be necessary as water quality drops. For reliable operation, your site may require water treatment.

CAUTION: draining a hot boiler may release dangerously hot water or steam, risking personal injury and damage to plumbing! Your local code may require that boiler pressure be limited to under 5 psi and require a special drain system to drain a hot boiler while under pressure!

Local water conditions and the amount of time per day that the generator operates will determine the necessary draining and cleaning intervals. We recommend draining daily or after every use and inspecting for properly flowing drain at least monthly. If you drain it shortly before starting the generator, you will start your bath with clean, fresh water, too. A slow running drain or mineral build up in the gauge glass may indicate excessive build up in the tank and a more thorough cleaning should be done immediately.

We recommend inspecting for a clear water gauge glass at least monthly. Also, the gauge glass should be drained at least monthly, more often with poor water quality: while the generator is pressured, use a wrench to open the drain cock on the bottom gauge valve for a couple seconds. A safety device is included in each gauge valve to prevent loss of steam and water should the gauge glass be broken. The gauge glass drain procedure will reduce the risk of plugging up the valve or its pressure stop. Use **CAUTION** when performing this routine to protect yourself from the hot water and steam released from the gauge drain!

Failure to properly maintain the generator can cause equipment failure and may void the warranty.

Using the CoolFlush™ Auto Drain requires setting its clock or using the manual **ELECTRONIC DRAIN** switch on the generator's switch panel. Set the Drain Clock's tabs inward (so orange is showing) for the time you wish the generator to drain. If the generator also uses a Run Clock, a good time to drain the generator is shortly before the Run Clock is scheduled to start the generator for the day. **CAUTION** If draining a hot generator, care must be taken to ensure it may drain safely while unattended.

Note: The manual drain valve must be left open for the electronic drain to work properly and the tank select jumper on the generator's circuit board must be positioned correctly to provide proper drain cycle timing for the CoolFlush™ system. *If the jumper is mis-set due to part replacement, a 12-24kW generator may overflow and have water run out the steam head during the drain cycle and a 30-48kW generator may drain hot water.*

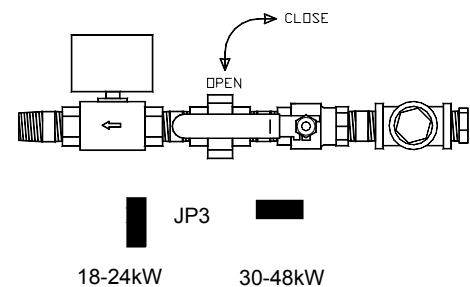

The **CoolFlush™ Auto Drain** system uses a computer controlled drain cycle to add and drain water in steps, rinsing the tank and draining water at or below 140°F. This will also eliminate the need for special drain systems or blowdown tanks in most jurisdictions. **For safety and reliability always plumb the drain with piping suitable for 240°F minimum.**

The drain cycle begins when started by the Drain Clock, first releasing any stored steam to the steam room then adding, mixing and draining water a few times. Once the cycle is complete, the generator returns to its normal operation. If the steam bath is operating when the CoolFlush™ cycle is started, the computer will wait until the room is up to temperature before beginning the drain cycle in order to reduce the effects felt by the bathers. If the room does not come up to temperature within 20 minutes, the drain cycle will begin anyway.

During the drain cycle, the upper Room Status LEDs will remain lit on the generator and, if the steam bath is in use, the thermostat and I60 LEDs will remain lit. The lower Room Status LEDs and the Refresh switch LEDs will be off. These LEDs will also blink to indicate slow draining and possible scale build up. This indicates that the generator requires maintenance. **The blinking will continue until power to the boiler is reset.**

Note: If the water drains too slowly, the upper Room Status LEDs and the thermostat and I60 LEDs will blink off once then light 5 seconds to indicate that the tank and drain may need cleaning. The drain cycle will continue to operate normally. If the drain is nearly plugged, the upper Room Status LEDs and the thermostat and I60 LEDs will blink off twice then light 5 seconds to indicate that the drain is not functioning and servicing is necessary. The drain cycle will not operate again until power has been reset.

To manually drain the generator (with a CoolFlush™ Auto Drain installed) set the **ELECTRONIC DRAIN** switch to the MANUAL OPEN position. *When an electronic drain is installed, make sure that the manual drain ball valve is always left in the open position. Do not touch the safety valve when the generator is hot: the valve will be dangerously hot!* Open a steam valve or the safety valve to relieve the vacuum caused by draining. A more effective drain and rinse procedure is to:

First set the **HEAT** switch to OFF then set the **BOILER OPERATION** switch to MANUAL RUN to start the generator.

Turn on the steam bath and verify the room's steam valve is open (this will help the generator drain more quickly in the following steps). Adjust the thermostat if needed to open the steam valve.

Check the water level showing in the gauge glass: when the level rises above the middle of the gauge, the water valve should close.

Set the **ELECTRONIC DRAIN** switch to the MANUAL OPEN position and set the **FEEDWATER** switch to STOP FILL to keep the water valve closed.

Watch the water level in the gauge glass: allow the generator to drain for at least 30 seconds after the level drops below the gauge glass for the generator to drain completely when clean. The water level should drop quickly and smoothly in a clean generator.

Toggle the **ELECTRONIC DRAIN** and **FEEDWATER** switches on and off as needed to add and drain water until it drains smoothly and quickly and the water in the gauge glass is clear. A drain is provided on the bottom water gauge valve to allow draining the gauge glass assembly if needed.

Reset all switches and the thermostat to their normal positions when done.

If the water drains slowly or sporadically, it may be necessary to remove the element assembly and clean the tank by hand. If this condition is seen, stop using the generator and call Saunatec Steam service for assistance.

A plugged port is provided next to the safety relief valve. This port is used to add cleaning solution to the generator without affecting other plumbing. *The safety valve must be installed in the upright position as shown.*

To manually drain the generator (without a CoolFlush™ Auto Drain installed), simply open the manual drain valve. The water draining from the generator may cause a vacuum, increasing the time needed to empty the generator. To speed up the drain time, a room steam valve should be opened or the lever on the pop-off safety valve may be raised to allow air into the generator to eliminate the vacuum. *Do not touch the safety valve when the generator is hot: the valve will be dangerously hot!* When the generator has finished draining, close the valves.

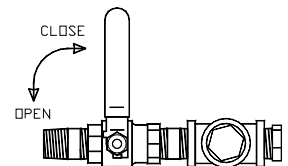

To rinse and drain the generator, follow the procedure above, opening and closing the manual valve as needed.

APPENDIX 1: RUN CLOCK AND AUTO DRAIN BLOWDOWN CLOCK

The AI series generators may be factory equipped with an optional Run Clock (Generator ON/OFF control) and/or a Drain Clock (operating an electronic Auto Drain blowdown valve). Three clocks are available: a 7-day clock typically used for Generator ON/OFF operation and a 24 hour clock typically used for daily blowdown (or optionally for Generator ON/OFF operation) and a 7-day programmable digital clock. The 7-day clock is adjustable in two hour intervals, the 24 hour clock is adjustable in 15 minute intervals and both clocks function in the same manner.

TO SET the 7-day and 24 hour clocks: Turn the clock dial to the right (clockwise) until the pointer matches the current time (and day) on the clock dial. Move set-tabs towards the clock center for the periods the generator should be ON (or the drain should be open) and away from the center for OFF (or drain closed) periods. *When the clock's pointer is in an area with orange showing, its switch will close and turn the generator ON or start the CoolFlush™ Auto Drain blowdown.*



NOTE: *the clocks operate on 120VAC supplied by the generator's control circuit. If this circuit loses power, the clocks must be reset to the correct time.*

To set the digital clock: Refer to the supplied instructions. Note: The digital clock has battery back-up and does not need to be reset after a loss of power.

CONNECTIONS: All 3 clocks connect in the same manner. *Always turn off all power to the generator before working on the electrical circuits!* Remove the top (angled) cover from the electrical box by removing the two mounting screws. Insert the clock in its mounting cut-out (RUN in the left hole, DRAIN in the right hole) and connect the clock's wires as shown below. Wires are marked with their locations.

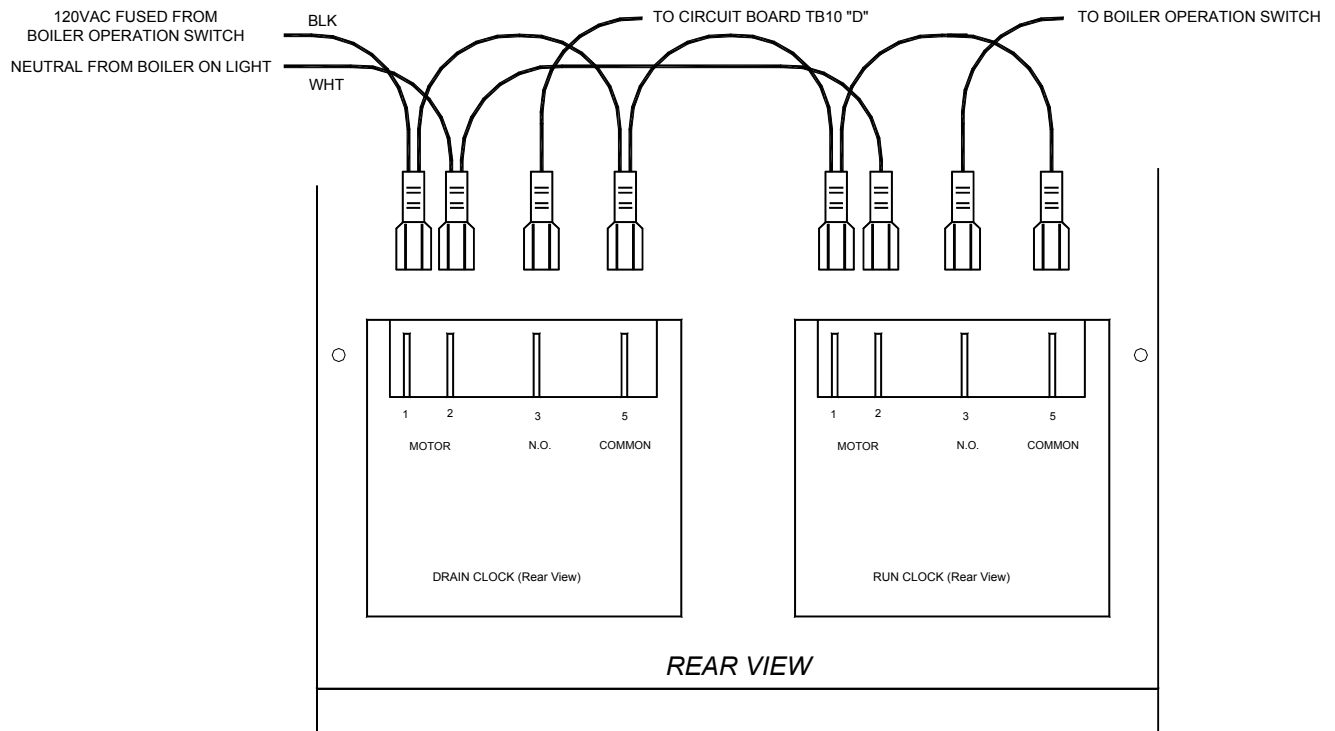

The drain valve's wires are connected to the power wire from the DRAIN CLOCK and a Neutral lead in the generator's contactor compartment.

APPENDIX 2: PRESSURE CONTROL ASSEMBLY

The AI boiler comes equipped with two pressure switches, wired in series, to control boiler heating. The primary switch automatically closes when the generator's internal pressure is low and opens when the pressure is high, turning the heating elements on and off as needed to create steam and maintain generator pressure. The second switch is a safety control: it remains closed during normal operation but, should the primary switch fail and the generator pressure increase too much, the safety switch will open, turning off the heating elements. The safety switch will remain open until the pressure has dropped and its reset button is manually pushed.

If the safety switch opens, there may be a problem with the primary switch. Check the primary switch operation by creating pressure in the generator. Also verify that the pressure gauge shows a smooth and steady pressure increase. If the primary switch does not open at the correct pressure or the gauge shows rapid pressure increases, release all pressure and remove line voltage from the generator and clean or repair the pressure control assembly as needed.

Adjust the pressure switches as shown below.

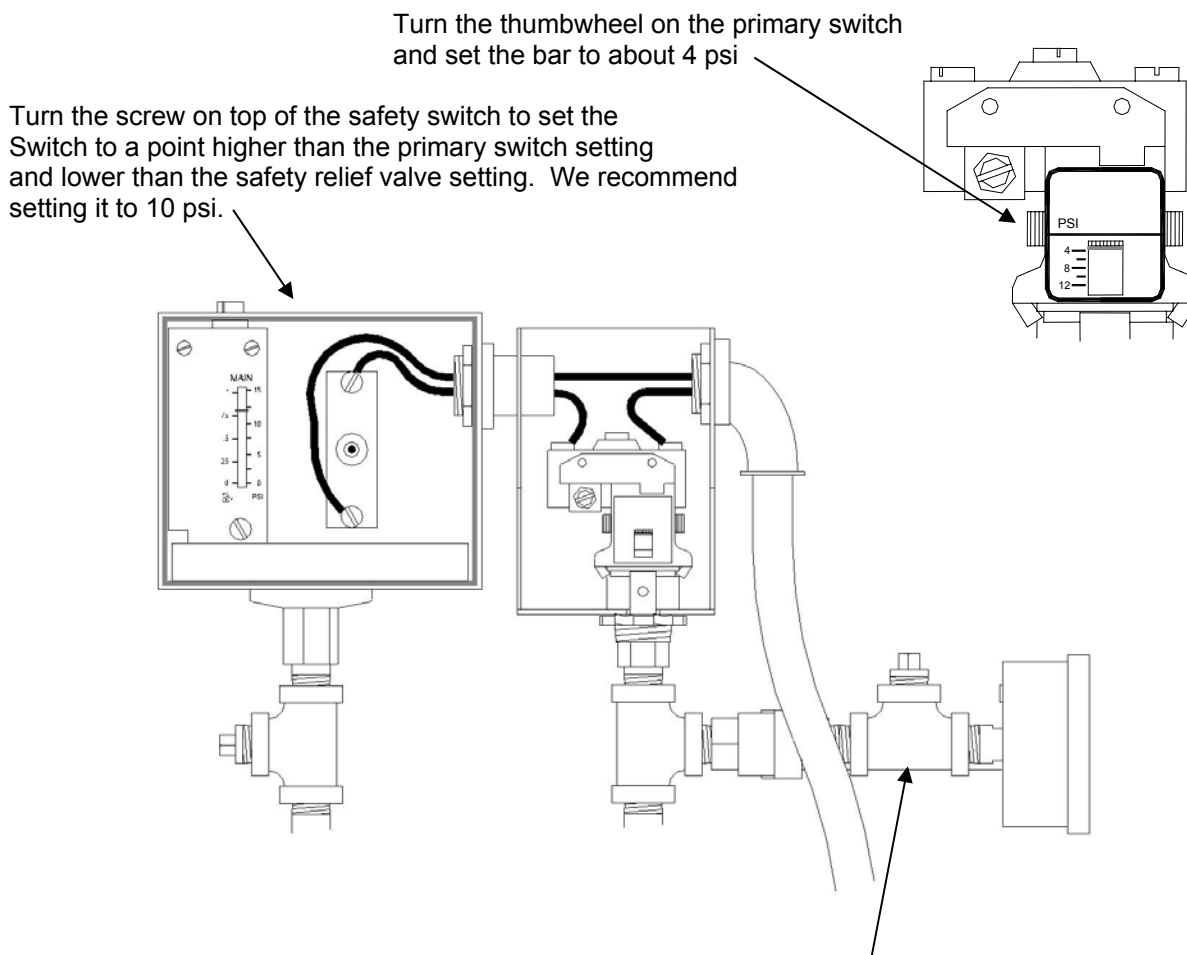

A fitting is supplied to allow connecting a second pressure gauge to easily replace the supplied gauge or to connect a second gauge for inspection. A ball valve is supplied assist with gauge changes; the valve should be left open during normal operation.

Appendix 3: LOW WATER CUTOFF INSTALLATION

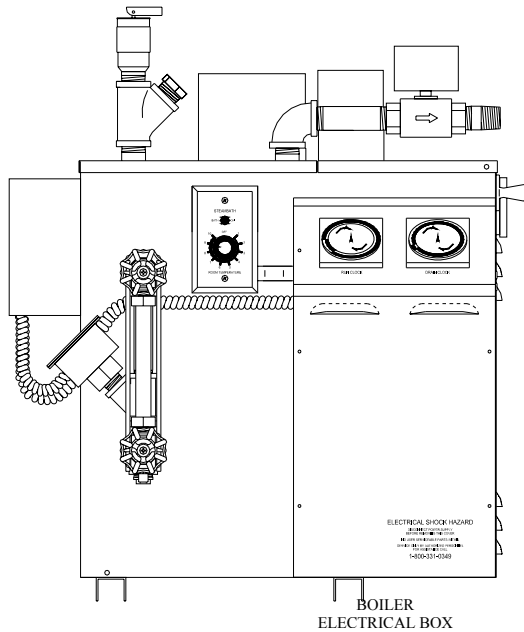

For those jurisdictions requiring one, an auxiliary Low Water Cut Off device with a manual reset switch may be added to boilers using the gage glass connections. The LWCO may be purchased factory installed or added later in the field.

The LWCO control may be mounted on the rear of the boiler using the conduit and wiring supplied in the LWCO kit or the control may be mounted on a nearby wall or other convenient location using materials supplied by the installer.

Four 18AWG wires are required between the LWCO control and the boiler's electrical box: 120VAC and Neutral to power the LWCO and two wires used to connect the LWCO's switch between the boiler's control

board and its pressure switches. Two more wires are used between the control and the LWCO level probe.

Refer to the wiring diagrams below when installing your LWCO.

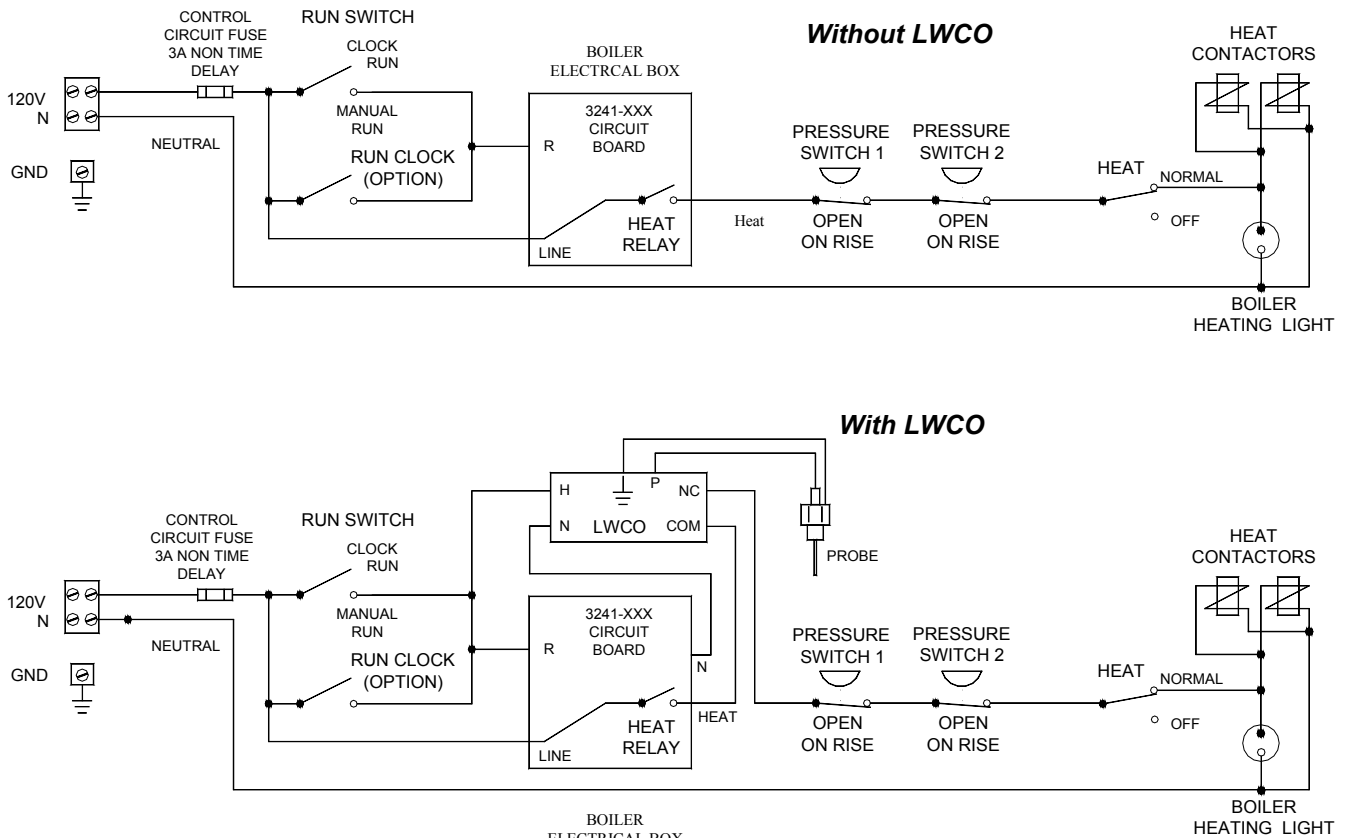

The following wiring steps refer to the Taco LFM120R1 LWCO available through Saunatec. See the manufacturer's instructions provided with the LWCO for further details.

After mounting the LWCO and its conduit:

1. Remove the jumper between the LWCO's terminal block's **COM** and **H** terminals, if installed.
2. Connect the LWCO's white wire to its **120VAC N** connection. At the other end of this wire, remove the white wire from the boiler PCA's HEAT **N** connection on its long terminal block (TB1), twist it together with the white wire from the LWCO, then place both wires back into the terminal block's **N** connection.
3. Connect the 39 inch black wire to the LWCO's terminal block at the **H** terminal. Run the wire through the conduit. In the electrical box, remove the wire from the circuit board's **R** connection in the small terminal block then twist that wire's end together with the black **H** wire from the LWCO and reinsert the twisted wire ends into the circuit board terminal block's **R** connection.
4. Connect one 47 inch black wire to the LWCO's terminal block's **COM** terminal and the other 47 inch black wire to the **NC** terminal. Run those wires through the conduit. In the electrical box, remove the circuit board's **HEAT** connection in the large terminal block then twist that wire's end together with the black wire from the LWCO's **NC** terminal and secure them together with a wire nut. Connect the other black wire from the LWCO's **COM** terminal to the circuit board terminal block's **HEAT** connection.
5. Test the installation following the manufacturer's instructions.

Test and Reset switches and status lights are located on the top of the LWCO. Refer to the manufacturer's instructions for further details.

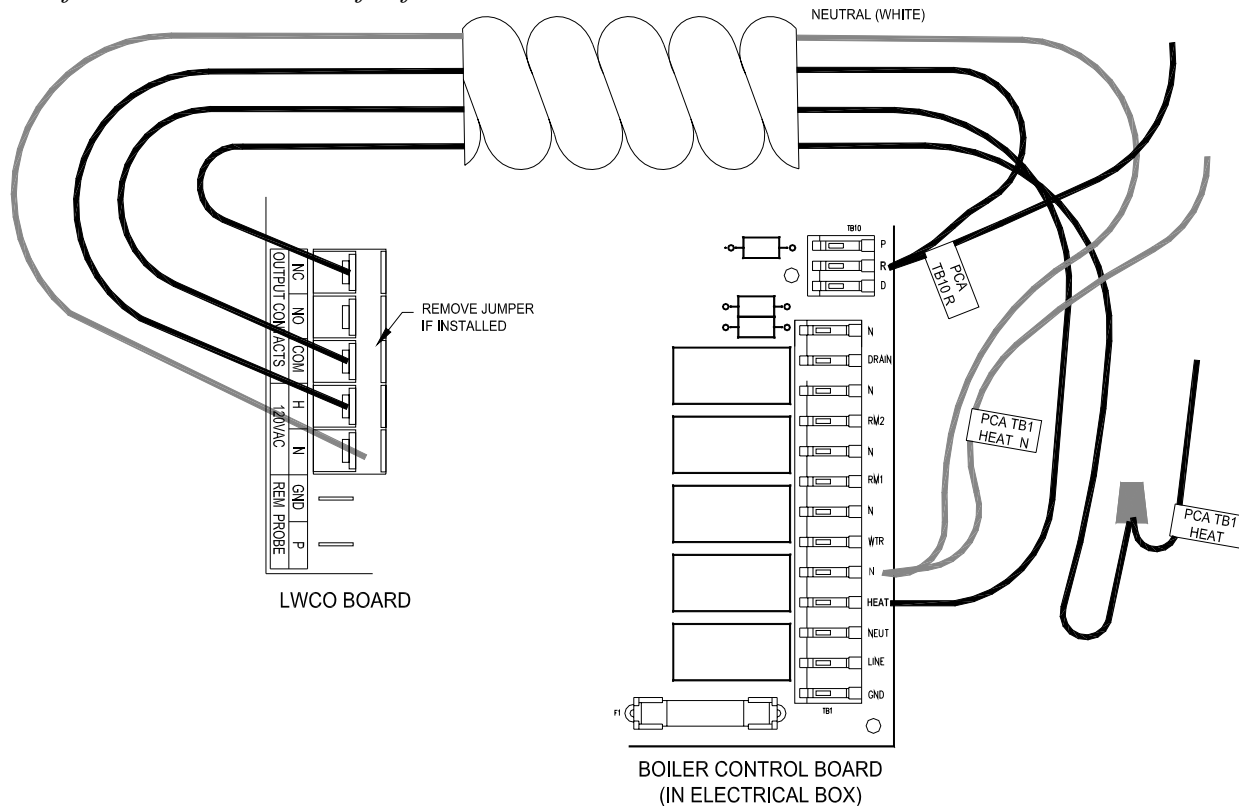

For service or assistance contact Saunatec Steam Service, 7:00 am to 5:00 pm Pacific Time at 1-800-331-0349