

QUICK START GUIDE



Modular 3000 Series • 3018 CLR • 115 V / 60 Hz

WELCOME TO U-LINE

Congratulations on your U-Line purchase. Your product comes from a company with over five decades and three generations of premium modular ice making, refrigeration, and wine preservation experience. U-Line continues to be the American leader, delivering versatility and flexibility for multiple applications including residential, light commercial, outdoor and marine use. U-Line's complete product collection includes modular Wine Captain® Models, Beverage Centers, Clear Ice Machines, Crescent Ice Makers, Glass & Solid Door Refrigerators, Drawer Models, Freezers, and Combo® Models.

U-Line has captivated those with an appreciation for the finer things with exceptional functionality, style, inspired innovations and attention to even the smallest details. We are known and respected for our unwavering dedication to product design, quality and selection. U-Line is headquartered in Milwaukee, Wisconsin and has shipped product to five continents for over two decades and is proud to have the opportunity to ship to you.

PRODUCT INFORMATION

Looking for additional information on your product? User Guides, Quick Reference Guides, CAD Drawings, Compliance Documentation, and Product Warranty information are all available for reference and download at u-line.com.

PROPERTY DAMAGE / INJURY CONCERNS

In the unlikely event property damage or personal injury is suspected related to a U-Line product, please take the following steps:

1. U-Line Customer Care must be contacted immediately at +1.800.779.2547.
2. Service or repairs performed on the unit without prior written approval from U-Line is not permitted. If the unit has been altered or repaired in the field without prior written approval from U-Line, claims will not be eligible.

SERVICE INFORMATION

Answers to Customer Frequently Asked Questions are available at u-line.com under Customer Care or you may contact our Customer Care group directly, contact information below.

GENERAL INQUIRIES

U-Line Corporation
8900 N. 55th Street
Milwaukee, Wisconsin 53223 USA
Monday - Friday 8:00 am to 4:30 pm CST
T: +1.414.354.0300
F: +1.414.354.7905
Email: sales@u-line.com
u-line.com

SERVICE & PARTS ASSISTANCE

Monday - Friday 8:00 am to 4:30 pm CST
T: +1.800.779.2547
F: +1.414.354.5696
Service Email: onlineservice@u-line.com
Parts Email: onlineparts@u-line.com

CONNECT WITH US



Designed, engineered and assembled in WI, USA

This Quick Start Guide covers the basics of installation and general use of your product. For more details, see the complete User Guide & Service Manual on u-line.com.

Contents

- 1 Safety and Warning
- 1 Environmental Requirements
- 2 Electrical
- 3 Water Hookup
- 5 Drain
- 7 Door Swing
- 8 General Installation
- 8 Integrated Panel Installation
- 10 Control Quick Guide
- 10 First Use
- 10 Ice
- 12 Sabbath Mode
- 13 Warranty



This product is eligible for an additional one-year warranty at no charge when you register your product on u-line.com. See complete warranty for details.

Safety and Warning

NOTICE

Please read all instructions before installing, operating, or servicing the appliance.

Use this appliance for its intended purpose only and follow these general precautions with those listed throughout this guide:

SAFETY ALERT DEFINITIONS

Throughout this guide are safety items labeled with a Danger, Warning or Caution based on the risk type:



Danger means that failure to follow this safety statement will result in severe personal injury or death.



Warning means that failure to follow this safety statement could result in serious personal injury or death.



Caution means that failure to follow this safety statement may result in minor or moderate personal injury, property or equipment damage.

Environmental Requirements

This model is intended for indoor/interior applications only and is not to be used in installations that are open/exposed to natural elements.

This unit is designed to operate between 50°F (10°C) and 100°F (38°C). Higher ambient temperatures may reduce the unit's ability to reach low temperatures and/or reduce ice production on applicable models.

For best performance, keep the unit out of direct sunlight and away from heat generating equipment.

In climates where high humidity and dew points are present, condensation may appear on outside surfaces. This is considered normal. The condensation will evaporate when the humidity drops.



Damages caused by ambient temperatures of 40°F (4°C) or below are not covered by the warranty.

Electrical



SHOCK HAZARD — Electrical Grounding Required. Never attempt to repair or perform maintenance on the unit until the electricity has been disconnected.

Never remove the round grounding prong from the plug and never use a two-prong grounding adapter.

Altering, cutting or removing power cord, removing power plug, or direct wiring can cause serious injury, fire, loss of property and/or life, and will void the warranty.

Never use an extension cord to connect power to the unit.

Always keep your working area dry.

NOTICE

Electrical installation must observe all state and local codes. This unit requires connection to a grounded (three-prong), polarized receptacle that has been placed by a qualified electrician.

The unit requires a grounded and polarized 115 VAC, 60 Hz, 15A power supply (normal household current). An individual, properly grounded branch circuit or circuit breaker is recommended. A GFCI (ground fault circuit interrupter) is usually not required for fixed location appliances and is not recommended for your unit because it could be prone to nuisance tripping. However, be sure to consult your local codes.

Water Hookup

PREPARE PLUMBING

The water valve uses a standard 1/4" (6.35 mm) compression fitting. A 10' (3 m) braided flexible water supply line is included with the unit.

WARNING

Prior to installation, determine if this product contains a gravity style drain or factory installed drain pump. Products without a drain pump may only use a gravity style drain. Failure to connect water supply or drain line connections properly may result in water leakage, personal injury, and/or property damage. Disconnect power and turn off water to the unit before attempting to alter these connections. These connections are the responsibility of the owner and must be connected per local plumbing code. If you are uncertain of how to safely and properly install this product, contact a licensed plumber.

Water Supply Connection

WARNING

Connect to potable water supply only.

CAUTION

Review, obey, and understand the local plumbing codes before you install your unit. Connect to the cold water supply. The water pressure should be between 20 and 120 psi (138 and 827 kPa). The water line MUST have a shut-off valve on the supply line.

CAUTION

Do not use any plastic water supply line. The line is under pressure at all times. Plastic may crack or rupture with age and cause damage to your home.

Do not use tape or joint compound when attaching a braided flexible water supply line that includes a rubber gasket. The gasket provides an adequate seal – other materials could cause blockage of the valve.

Failure to follow recommendations and instructions may result in damage and/or harm, flooding or void the product warranty.

CAUTION

Turn off water supply and disconnect electrical supply to unit prior to installation.

Use caution when handling back panel. The edges could be sharp.

1. Turn off water supply and disconnect electrical supply to product prior to attempting installation.
2. Remove the grille/access panel in the front and the back panel.

3. Locate water valve in the front of the unit and thread water supply line through.

Route the water supply line through the unit so it does not come into contact with any internal components other than the solenoid valve. Normal operation creates some vibration. A water supply line contacting an internal component or cabinet wall can cause excessive noise during operation or damage to the line.

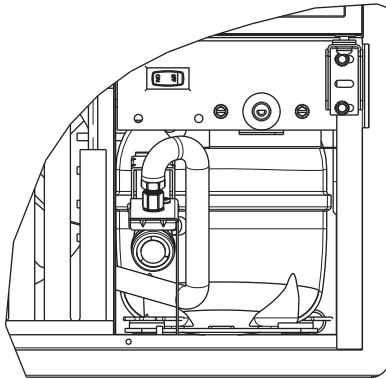

8. Install retaining clip.

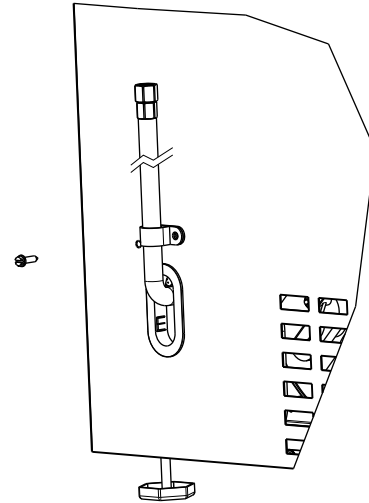

4. On the back panel, break away filler feature in bushing with flat screwdriver.

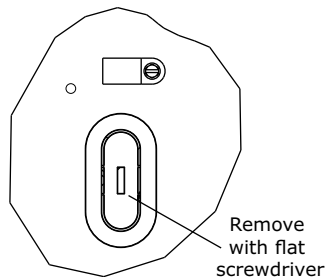

5. Thread water line through back panel hole (with bushing) and connect to cold water supply line.

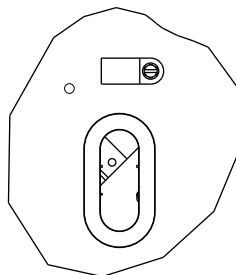

6. Turn on water supply and check for leaks.
7. Reinstall back panel and grille/front access panel.

Drain

Model numbers including “-00” or “-07” do not include a factory installed drain pump.

Model numbers including “-40” or “-47” include a factory installed drain pump.

DRAIN CONNECTION



If your U-Line unit did not come with a factory installed drain pump you must use a gravity style drain connection. For assistance in determining if your unit has a pump please contact U-Line. The floor drain must be large enough to accommodate drainage from all attached drains. Follow these guidelines when installing drain lines to prevent water from flowing back into the ice maker storage bin and/or potentially flowing onto the floor, which may result in personal injury or property damage.

NOTICE

Drain can NOT be located directly below the unit. Unit has a solid base that will not allow the unit to drain below itself.

There is a possibility that hose connections may have loosened during shipment.

Verify all connections and fittings are free from leaks.

GRAVITY DRAIN

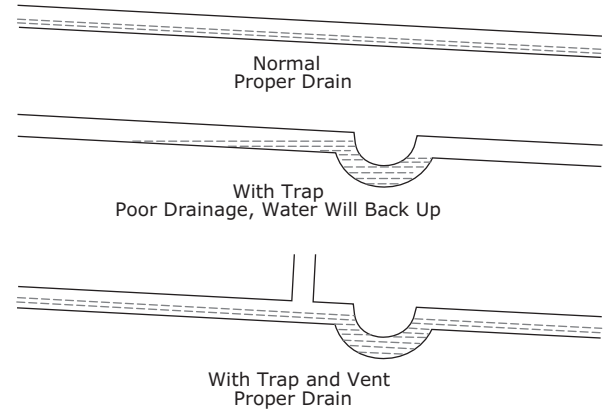

A gravity drain may be used if:

Drain line has at least a 1" drop per 48" (approximately 2 cm drop per 100 cm) of run.

Drain line does not create traps and is vented per local code.

1. Cut the pre-installed drain tube to length.
2. Connect to your local plumbing per the local code.
3. If necessary, insulate drain line to prevent condensation.



Failure to connect water supply or drain line connections properly can result in personal injury and property damage. Gravity drain connections must be routed downward from the rest of the unit at the rate of 1/4" per foot (1 cm per 50 cm).

FACTORY INSTALLED DRAIN PUMP

If your drain line will run up to a stand pipe, disposal or spigot assembly, or does not otherwise meet the requirements for a gravity drain, you may have ordered a pre-installed U-Line P60 drain pump.

If you need to install a P60 drain pump into your unit, see DRAIN PUMP section in the User Manual.

See below for typical installations requiring a drain pump.

Y-Branch Tailpiece
P60 Pump Required

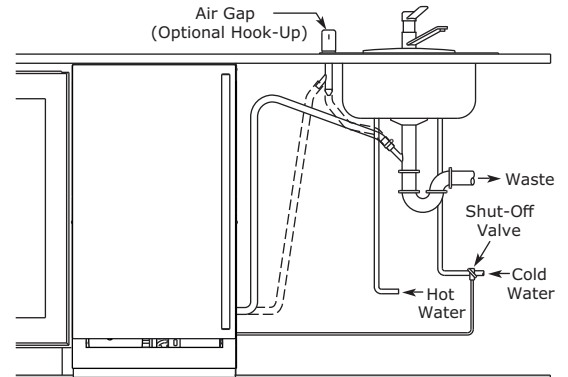

NOTICE

The maximum lift for the P60 drain pump is 10 feet. This must be done as close to the rear of the unit as possible.

Stand Pipe
P60 Pump Required

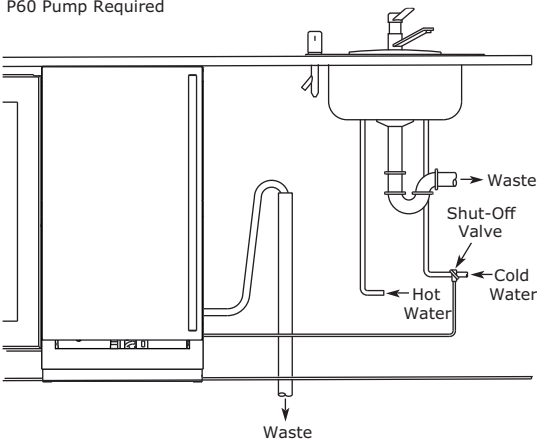

Disposal Assembly
P60 Pump Required

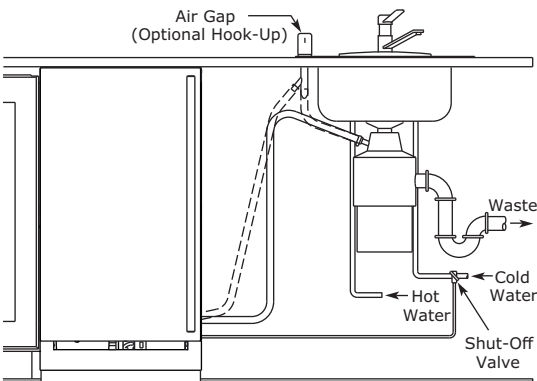

Door Swing

For Integrated models that are installed adjacent to a wall, 1/4" (6 mm) clearance is recommended from wall on hinge side to allow the door to open 90°. Allow for additional space for any knobs or pulls installed on the integrated panel/frame.

Stainless Steel models that are installed adjacent to a wall require 2-1/4" (57 mm) door clearance on hinge side to allow for door handle.

Units have a zero clearance when installed adjacent to cabinets.

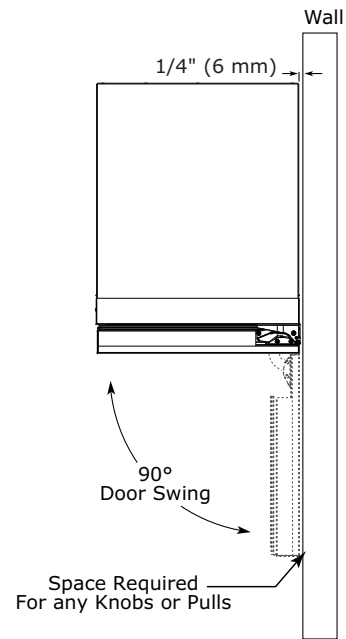

Integrated

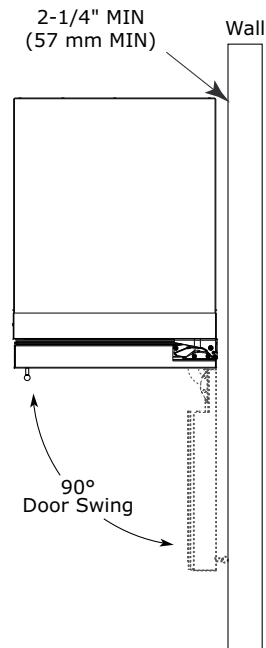

Stainless

General Installation

1. Use a level to confirm the unit is level. Level should be placed along top edge and side edge as shown.

2. If the unit is not level, remove grille and adjust legs as necessary. Use included tool to adjust the height of the rear legs.

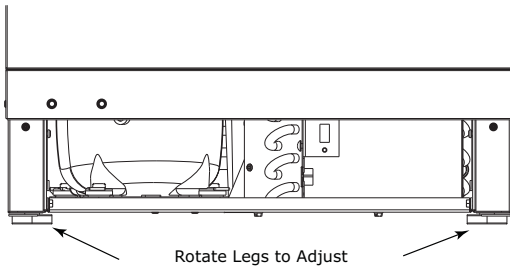
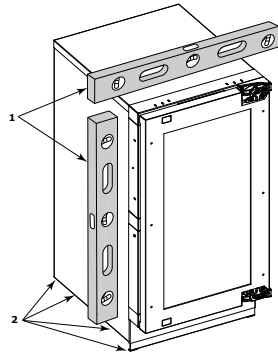

3. Confirm the unit is level after each adjustment and repeat the previous steps until the unit is level.

INSTALLATION TIP

If the room floor is higher than the floor in the cutout opening, adjust the rear legs to achieve a total unit rear height of 1/8" (3 mm) less than the opening's rear height. Shorten the unit height in the front by adjusting the front legs. This allows the unit to be gently tipped into the opening. Adjust the front legs to level the unit after it is correctly positioned in the opening.

INSTALLATION

1. Plug in the power/electrical cord.
2. Gently push the unit into position. Be careful not to entangle the cord or water and drain lines.
3. Re-check the leveling, from front to back and side to side. Make any necessary adjustments. The unit's top surface should be approximately 1/8" (3 mm) below the countertop.
4. Install the anti-tip bracket.
5. Remove the interior packing material and wipe out the inside of the unit with a clean, water-dampened cloth.

Integrated Panel Installation

1. Fully open door.
2. Starting at corner, pull gasket away from door.
3. Continue to pull gasket free from gasket channel.
4. Upon removal, lay gasket down on a flat surface.
5. The panel should be aligned with the outside edge (opposite the hinge) and high enough to align with the highest point in the door.

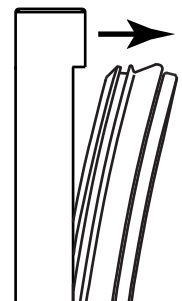

Align Top Of Panel With Highest Point Of Door

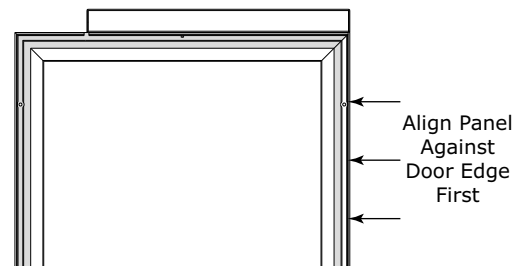

NOTICE

Due to differences in floor construction or surrounding cabinetry, the panel may not sit flush with the top of the door.

6. Secure integrated panel to door using clamps. A robust tape may also be used. U-Line recommends the use of bar clamps to secure the panel to the door. If using tape, be certain the tape will not damage panel finish upon removal.

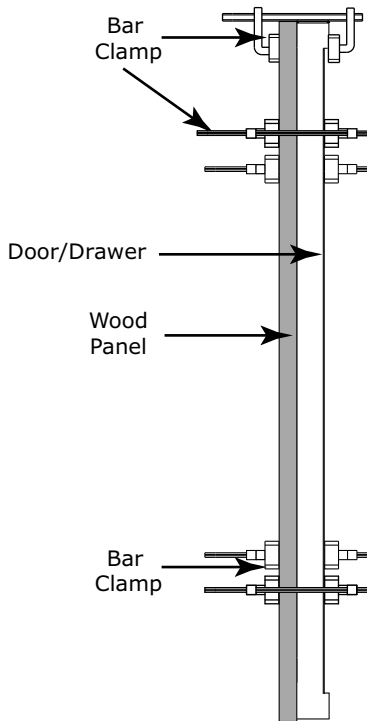

7. Using a 7/64" (3 mm) drill bit, drill 6 pilot holes into the wood panel 1/2" (12 mm) deep using the holes in the door frame as a guide.

NOTICE

It is important to ensure that all drilled holes are drilled to the correct depth in order to avoid splits in the wood when hardwood is installed.

8. Locate 6 of the #6x 1-1/2" (38 mm) screws provided with your unit.

9. Using a Phillips screwdriver, place one screw into each of the 6 pilot holes and screw down. Do not overtighten screws.

10. Ensure the screws sit flush against the bottom of the channel.

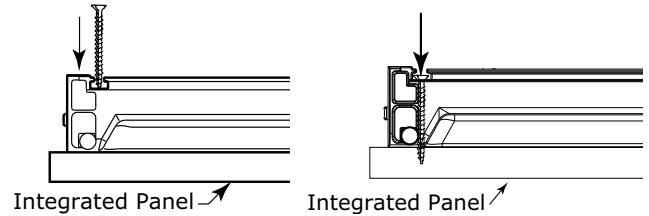

11. Remove clamps from door.

NOTICE

If panel requires additional adjustment after removing clamps, slightly loosen each screw and adjust panel as necessary. Tighten screws upon completion.







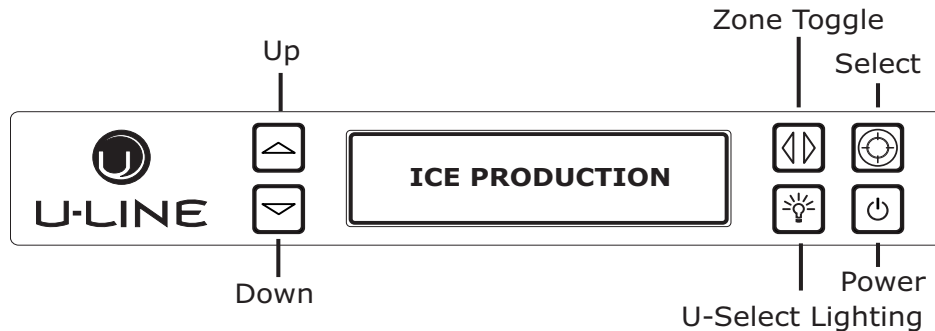





12. Starting at the corners, re-install the gasket into the gasket channel in the frame. Make sure the gasket is fully seated.

Control Quick Guide

Actual Display:



Control Function Guide:

FUNCTION	COMMAND	DISPLAY/OPTIONS
OFF	Press  and hold	Display will count down from 5 to off
ON	Press  and release	Unit will come on immediately
Adjust lighting	Press  to adjust lighting	Press  or  to set low, medium or high
Customer menu	Press  and hold for 5 seconds	Press  or  to scroll through menu
Service menu	Press  or  and hold for 5 seconds	Press  or  to scroll through menu.

First Use

All U-Line controls are preset at the factory. Initial startup requires no adjustments.

NOTICE

U-Line recommends discarding the ice produced during the first two to three hours of operation to avoid possible dirt or scale that may dislodge from the water line.

When plugged in, the unit will begin operating under the factory default setting. Follow the on screen prompt for language selection and temperature units.

To turn the unit off, press  and hold for 5 seconds and release. The display will show a countdown to switching the unit off.

To power your unit on, simply press  and the unit will immediately switch on.

Ice

ICE CUBE THICKNESS ADJUSTMENT

NOTICE

Ice thickness adjustment should only be made one increment at a time. Allow ice maker production to stabilize for 24 hours before rechecking ice thickness.

Ice is produced in layers resulting in a clear cube. Ice in bin may develop surface frost which disappears when cube is placed in liquid.

Ice cubes in any given batch will vary, so it is necessary to choose cubes from the sample area for comparison when making adjustments.

The ice cube thickness is factory set for best overall performance. The factory setting "0" is designed to maintain an ice bridge of approximately 1/16" to 1/8" (1.6 mm to 3.2 mm) under normal conditions, resulting in a dimple of approximately 1/4" to 1/2" (6.4 mm to 12.7 mm) in depth. A fuller cube with less of a dimple results in a thicker ice bridge. As the ice bridge thickens, the tendency for the cubes to stay together as a slab increases. A bridge thicker than 1/8" (3.2 mm) may cause cubes to overfill the ice bucket.

32 ice cubes are formed on a 4 x 8 slab during each cycle. Each cycle takes approximately 15-20 minutes at the default cube thickness (0).

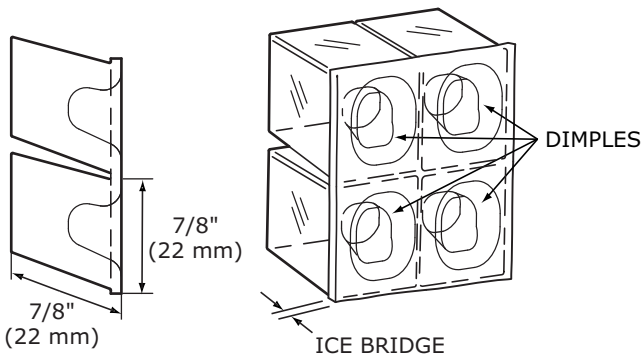

Your clear ice machine is pre-set to produce ice between the optimal dimensions illustrated below:



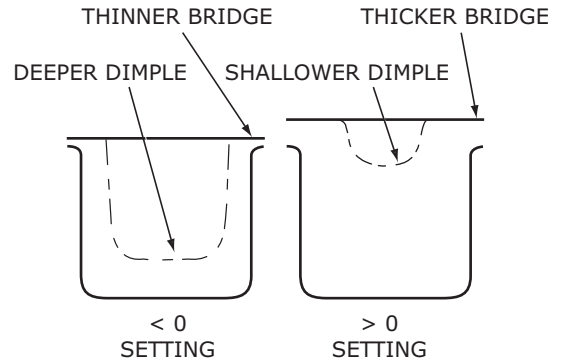
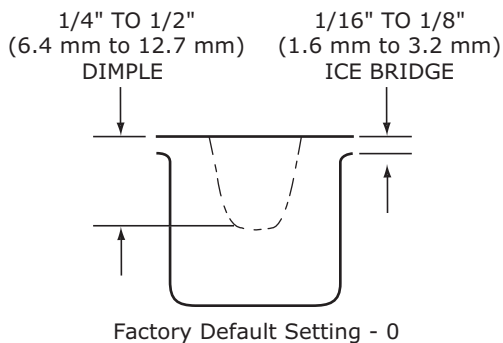

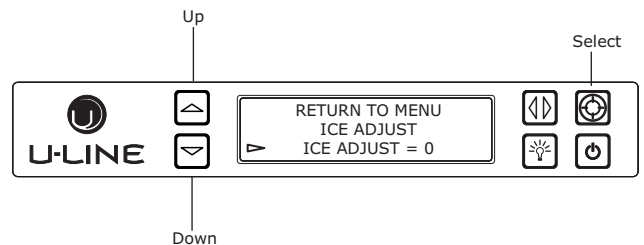

Cube Details



ICE ADJUST



Adjust ice thickness as follows:

1. Press  and  and hold for 5 seconds to enter the Customer Menu.
2. Press  to select "Ice Adjust".
3. Press . The selection will begin to flash.
4. Press  to make the ice thicker or  to make the ice thinner. Press  to confirm your choice.

Sabbath Mode

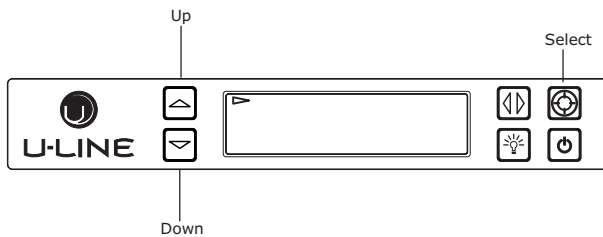
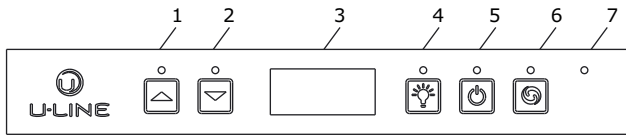

U-Line Clear Ice Machine models are Star-K certified and can be used during the Sabbath. View a full list of Star-K certified U-Line units at www.star-k.org.

To prepare the unit for the Sabbath:

1. Press  and hold the until the unit turns off.
2. No new ice will form when the unit is off, but previously made ice will still be accessible/present for over 24 hours. Pump equipped models will continue to remove water as needed even if the unit is off.

Sabbath Mode remains active until  is pressed again and the unit turns on.

U-Line Corporation (U-Line) Limited Warranty

One Year Limited Warranty

For one year from the date of original purchase, this U-Line product warranty covers all parts and labor to repair or replace any part of the product that proves to be defective in materials or workmanship. For products installed and used for normal residential use, material cosmetic defects are included in this warranty, with coverage limited to 60 days from the date of original purchase. All service provided by U-Line under the above warranty must be performed by U-Line factory authorized service, unless otherwise specified by U-Line. Service provided during normal business hours.

Available Second Year Limited Warranty

Beyond the standard one year warranty outlined above, U-Line offers an extension of the one year warranty coverage for an additional second year from the date of purchase, free of charge. To take advantage of this second year warranty, you must register your product with U-Line within two months from the date of purchase at u-line.com providing proof of purchase.

Five Year Sealed System Limited Warranty

For five years from the date of original purchase, U-Line will repair or replace the following parts, labor not included, that prove to be defective in materials or workmanship: compressor, condenser, evaporator, drier, and all connecting tubing. All service provided by U-Line under the above warranty must be performed by U-Line factory authorized service, unless otherwise specified by U-Line. Service provided during normal business hours.

Terms

These warranties apply only to products installed in any one of the fifty states of the United States, the District of Columbia, or the ten provinces of Canada. The warranties do not cover any parts or labor to correct any defect caused by negligence, accident or improper use, maintenance, installation, service, repair, acts of God, fire, flood or other natural disasters. The product must be installed, operated, and maintained in accordance with the U-Line User Guide.

The remedies described above for each warranty are the only ones that U-Line will provide, either under these warranties or under any warranty arising by operation of law. U-Line will not be responsible for any consequential or incidental damages arising from the breach of these warranties or any other warranty, whether express, implied, or statutory. Some states do not allow the exclusion or limitation of incidental or consequential damages, so the above limitation or exclusion may not apply to you. These warranties give you specific legal rights, and you may also have other rights which vary from state to state.

Any warranty that may be implied in connection with your purchase or use of the product, including any warranty of *merchantability* or any warranty *fit for a particular purpose* is limited to the duration of these warranties, and only extends to five years in duration for the parts described in the section related to the five year limited warranty above. Some states do not allow limitations on how long an implied warranty lasts, so the above limitations may not apply to you.

- The warranties only apply to the original purchaser and are non-transferable.
- The second year and five year warranties cover products installed and used for normal residential or designated marine use only.
- The warranties apply to units operated outside only if designed for outdoor use by model and serial number.
- Replacement water filters, light bulbs, and other consumable parts are not covered by these warranties.
- The start of U-Line's obligation is limited to four years after the shipment date from U-Line.
- In-home instruction on how to use your product is not covered by these warranties.
- Food, beverage, and medicine loss are not covered by these warranties.
- If the product is located in an area where U-Line factory authorized service is not available, you may be responsible for a trip charge or you may be required to bring the product to a U-Line factory authorized service location at your own cost and expense.
- Units purchased after use as floor displays are covered by the limited one year warranty only and no coverage is provided for cosmetic defects.
- Signal issues related to Wi-Fi connectivity are not covered by these warranties.

For parts and service assistance, or to find U-Line factory authorized service near you, contact U-Line:
8900 N. 55th Street, Milwaukee, WI 53223 • u-line.com • onlineservice@u-line.com • +1.800.779.2547

