

# USE AND CARE GUIDE

## WALL MOUNTED HOOD

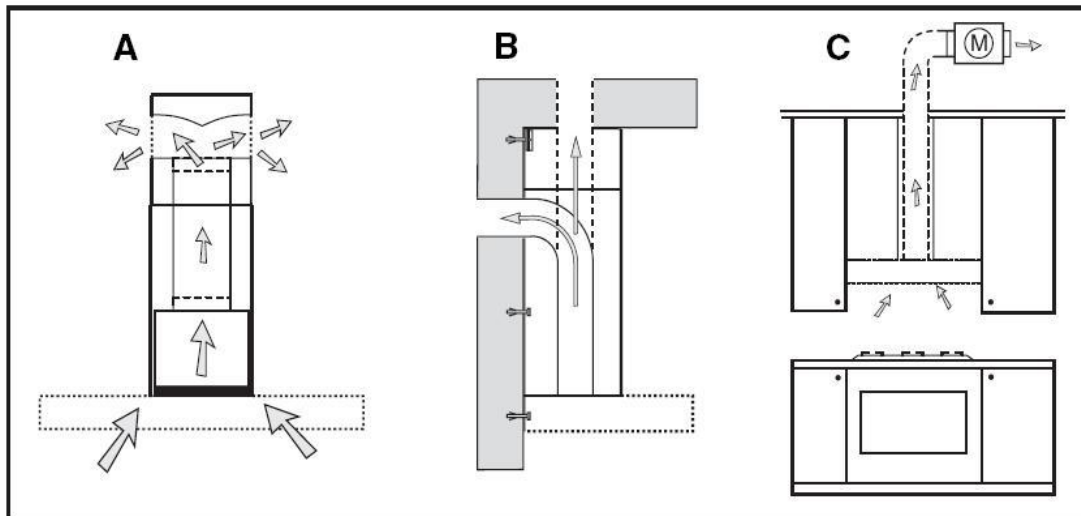

Fig.1

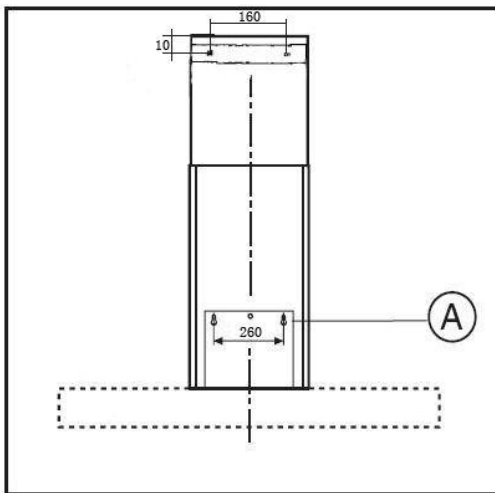

Fig.2

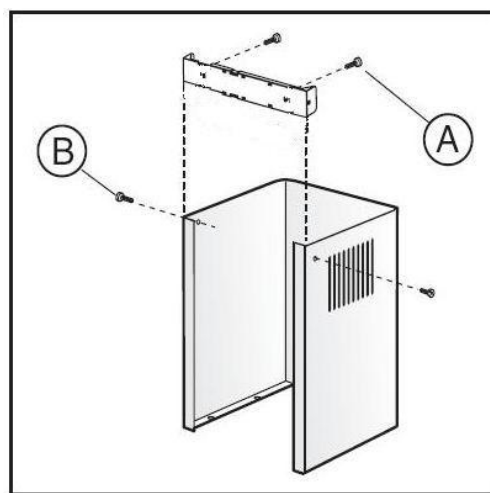

Fig.3

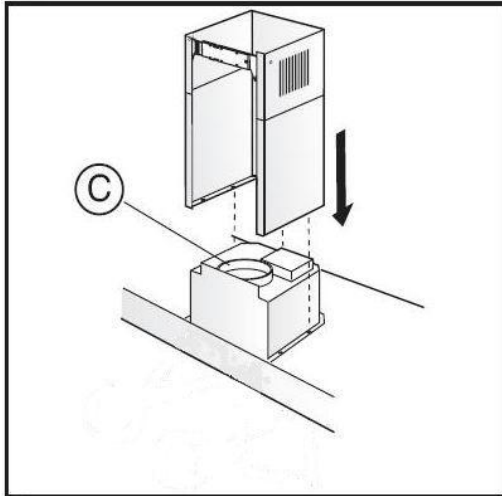

Fig.4

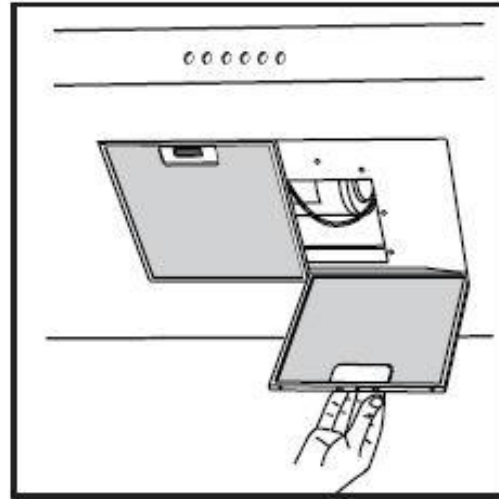

Fig.5

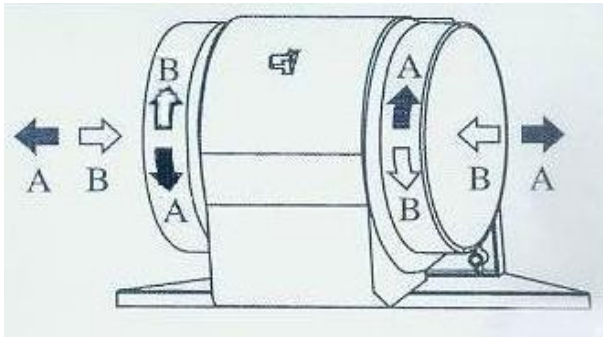

Fig.6

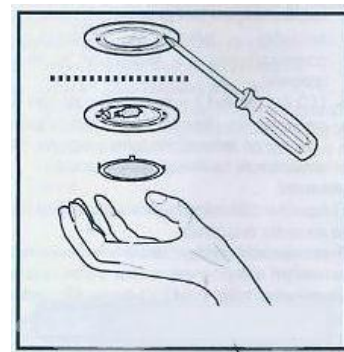

Fig.7



Fig.8

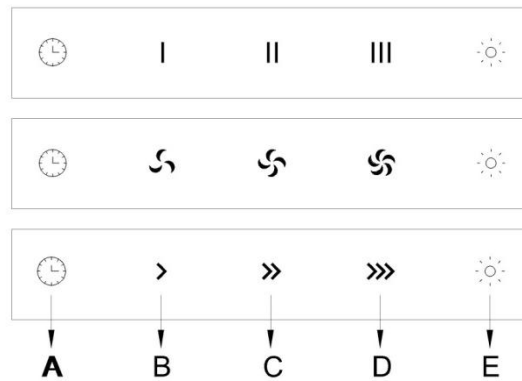

Fig.9

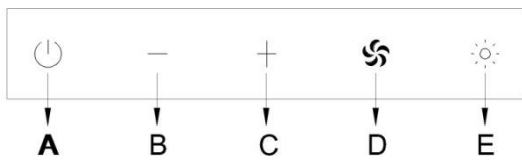

Fig.10

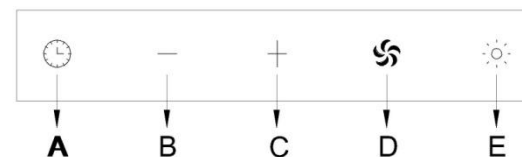

Fig.11

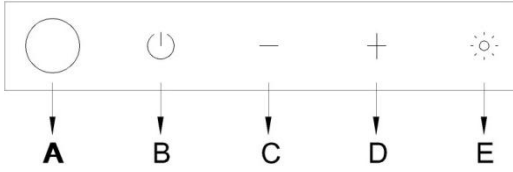

Fig.12

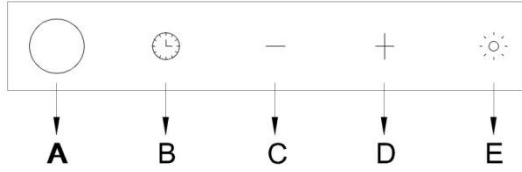

Fig.13

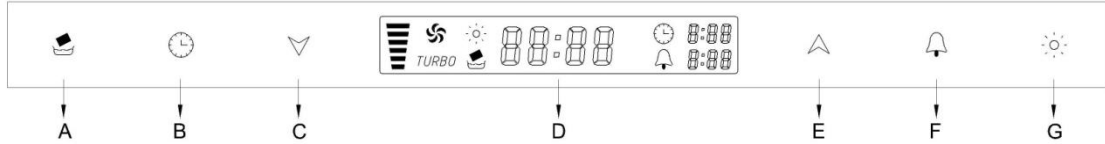

Fig.14

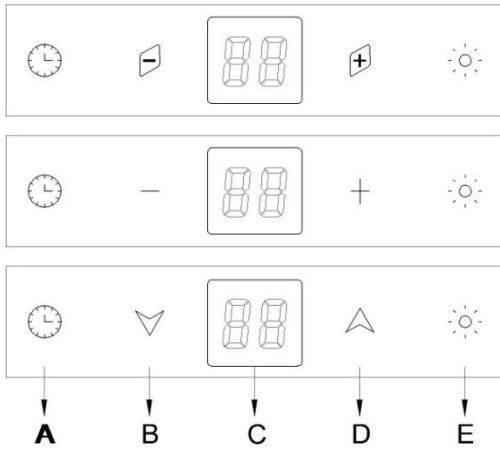

Fig.15

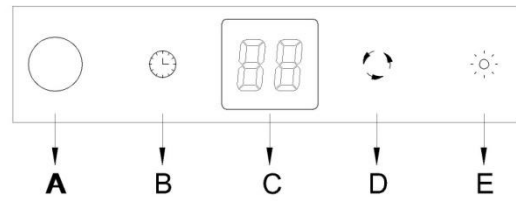

Fig.16

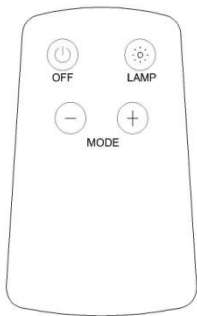

Fig. 17

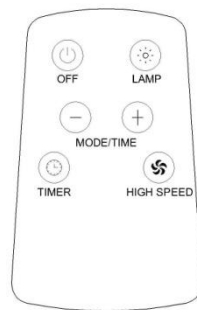

Fig. 18

## GENERAL

Carefully read the following important information regarding installation safety and maintenance. Keep this information booklet accessible for further consultations. The appliance has been designed for use in the ducting version (air exhaust to the outside – Fig.1B), filtering version (air circulation on the inside – Fig.1A) or with external motor (Fig.1C).

## SAFETY PRECAUTION

1. Please take note that when the cooker hood is operating simultaneously with an open fireplace or burner that depend on the air in the environment, the cooker hood may remove the air from the environment which a burner or fireplace need for combustion. The negative pressure in the environment must not exceed 4Pa ( $4 \times 10^{-5}$  bar). Provide adequate ventilation in the environment for a safe operation of the cooker hood. Follow the local laws applicable for external air evacuation.

**Before connecting the model to the electricity network:**

- control the data plate (positioned inside the appliance) to ascertain that the voltage and power correspond to the network and the socket is suitable. If in doubt please ask qualified electrician for help.

**2. WARNING!**

In certain circumstances electrical appliances may be a danger hazard.

- A) Do not check the status of the filters while the cooker hood is operating
- B) Do not touch bulbs or adjacent areas, after prolonged use of the lighting installation.
- C) Flambe cooking is prohibited underneath the cooker hood
- D) Avoid free flame, as it is damaging the filters and can cause fire hazard
- E) Constantly check food frying, the overheated oil may become a fire hazard
- F) Disconnect the electrical plug prior to any maintenance.
- G) There shall be adequate ventilation in the room when the range hood is operating
- H) There is a risk of fire if cleaning is not carried out in accordance with the instructions
- I) If the supply cord is damaged, it must be replaced by the manufacturer or its service agent or a similarly qualified person
- J) This appliance is not intended for use by persons (including children) with reduced physical, sensory or mental capabilities, or lack of experience and knowledge, unless they have been given supervision or instruction concerning use of the appliance by a person responsible for their safety.
- K) Children should be supervised to ensure that they do not play with the appliance.
- L) The air must not be discharged into a flue that is used for exhausting fumes from appliances burning gas or other fuels
- M) The minimum distance between the supporting surface for the cooking vessels on the hob and the lowest part of the range hood shall be at least

65cm. The instructions for installation of the gas hob specify a greater distance has to be taken into account if requirement stated  
O) Regulation concerning the discharge of air has to be fulfilled.

## INSTALLATION INSTRUCTIONS

Assembly and electrical connections must be carried out by specialized personnel.

### • Electric Connection

The appliance has been manufactured as class **I**, therefore earth cable is necessary.

The connection to the mains is carried out as follows:

	IEC227	North America
L=live	Brown	Black
N=neutral	Blue	White
E=earth	Green/Yellow	Green

If the plug is not provided, connect the electrical load as indicated on the description label. When a plug is provided, the cooker hood must be installed in order that the plug is easy to access.

An omnipolar switch with a minimum aperture of 3mm between contacts; in line with the electrical load and local standards, must be placed between the appliance and the network in the case of direct connection to the electrical network.

- The minimum distance between the support surfaces of the cooking pots on the cooker top and the lowest part of the cooker hood must be at least 65 cm. If a connection tube composed of two parts is used, the upper part must be placed outside the lower part.

Do not connect the cooker hood exhaust to the same conductor used to circulate hot air or for evacuating fumes from other appliances generated by other than an electrical source.

Before proceeding with the assembly operations, remove the anti-grease filter(s) (Fig.5) so that the unit is easier to handle.

In the case of assembly the appliance, in the suction version prepare the hole

for evacuation of the air.

- **FIXING TO THE WALL**

Drill the holes **A** respecting to the distances indicated (Fig.2).

Fix the appliance to the wall and align it in horizontal position to the wall units. When the appliance has been adjusted, fix the hood using the screws **A**.

For the various installations use screws and screw anchors suited to the type of wall (e.g. reinforced concrete, plasterboard, etc.). If the screws and screw anchors are provided with the product, kindly check the screws are suitable for the type of wall in which the hood is to be fixed.

- **FIXING THE DECORATIVE TELESCOPIC FLUE**

Arrange the electrical power supply within the dimensions of the decorative flue. If your appliance is to be installed in the ducting version or in the version with external motor, prepare the air exhaust opening. Adjust the width of the support bracket of the upper flue (Fig.3). Then fix it to the ceiling using the screws **A** (Fig.2) make sure that it is in line with your hood and respecting the distance from the ceiling indicated in Fig.2. Connect the flange **C** to the air exhaust hole using a connection pipe (Fig.4).

To transform the hood from a ducting version into a filtering version, ask your dealer for the charcoal filters and please follow the installation instructions.

- **FILTERING VERSION**

Install the hood and the two flues as described in the paragraph for installation of the hood in ducting version. To assemble the filtering flue refers to the instructions contained in the kit. If the kit is not provided, please order it from your dealer. The charcoal filters must be fitted in the ducting unit located inside the hood.

## **USE AND MAINTENANCE**

- It is recommended to operate the appliance prior to cooking.

It is recommended to leave the appliance in operation for 15 minutes after cooking is terminated in order to completely eliminate cooking vapors and odours.

The proper function of the cooker hood is conditioned by the regularity of the

maintenance operations, in particular, the active carbon filter.

- The anti-grease filters capture the grease particles suspended in the air, and are therefore subject to clogging according to the frequency of the use of the appliance.

In order to prevent fire hazard, it is recommendable to clean the filter at a maximum of 2 months by carrying out the following instructions:

- Remove the filters from the cooker hood and wash them in a solution of water and neutral liquid detergent, leaving to soak.
- Rinse thoroughly with warm water and leave to dry.
- The filters may also be washed in the dishwasher.

Please take note that the aluminum panels may alter in color after several washes.

- The active carbon filters purify the air that is replaced in the environment. The filters are not washable or reuseable and must be replaced at maximum every four months. The saturation of the active carbon filter depends on the frequency of use of the appliance, also by the type of cooking and the regularity of cleaning on the anti-grease filters. (Fig 6) To remove the charcoal filters place our hand on one filter at a time and turn it toward the front part. The charcoal filter can now be removed. Always ensure to replace both filters at the same time.

- Clean the fan and other surfaces of the cooker hood regularly using a cloth moistened with denatured alcohol or non abrasive liquid detergent.

- The illumination installation is designed for use during cooking and not for prolonged general illumination of the environment. Prolonged use of the illumination installation notably reduces the duration of the bulb.

Use a one-edged screwdriver or any other appropriate tool to lift and remove the overhead light fixture. Replace the damaged lamp. Use only halogen lamps as the original specification, avoiding contact with hands. Return the light fixture to its position (snap fastening). (Fig. 7)

- How to replace the charcoal filters:

- (1) Push the right middle corner on the glass of the decoration door (Fig.12), the decoration door will open (Fig.13).
- (2) Take out the aluminum filter (Fig.14);
- (3) Push the clips on the charcoal filters and then pull back, then the charcoal filters can be taken down (Fig.15).

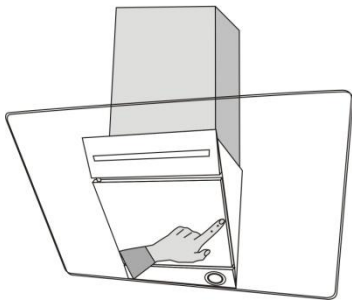

Fig.1

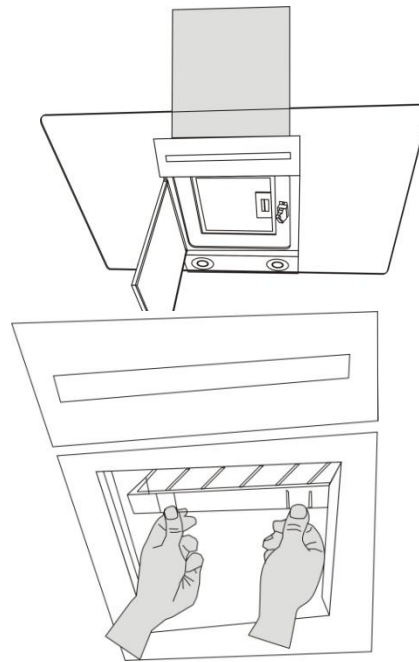

Fig.2

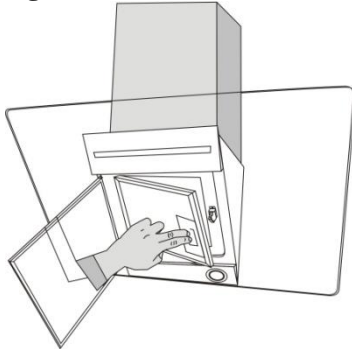

Fig.3

Fig.4

• **FUNCTION KEYS:** (Fig.8)

- A = OFF
- B = SPEED I / OFF
- C = SPEED II / OFF
- D = SPEED III / OFF
- E = LIGHT

• **FUNCTION KEYS:** (Fig.9)

- A= TIMER – 15 MINUTES
- B= SPEED I
- C= SPEED II
- D= SPEED III
- E =LIGHT

• If your appliance does not have the **INTENSIVE** speed function, press key A for two seconds and it will be activated for 15 minutes after which it will return to the previously set speed. If the function program of the unit is active the LED will flash.

By pressing any key except the key for the light, the hood will return immediately to its normal functioning.

**The “automatic stop timer” mode delays stopping operation of the hood, the mode will continue functioning for 15 minutes at the operating speed set at the time this function is activated.**

■ **FUNCTION KEYS:** (Fig. 10)

- A == OFF
- B == SPEED 1/ “-” Control
- C == SPEED 2/ “+” Control



D == SPEED 4  
E == LIGHT

By pressing key B, C or D individually, the speed for each key will be the same as above table. At the same time indicated light will flash on the each function key button. To stop the speed function press key A.

If Speed 3 is required, press key C adjust “+” . At Speed 3 program both key B and key C indication light will flash on each function key button.

To on the light press key E. To off the light press key E again.

■ **FUNCTION KEYS: (Fig. 11)**

A == Automatic Stop Timer —15 minutes  
B == Speed 1/ “-” Control  
C == Speed 2/ “+” Control  
D == Speed 4  
E == Light

By pressing key B, C or D individually, the speed for each key will be the same as above table. At the same time indicated light will flash on the each function key buttons. To stop the speed function press key A.

If Speed 3 is required, press key C adjust “+” . At Speed 3 program both key B and key C indication light will flash on each function key button.

To on the light press key E. To off the light press key E again.

When the appliance and light are ON together or separately, press key A the Automatic Stop Timer will start the 15 minutes count down. Indication light on the key A button will flash for the duration. To stop the Automatic Stop Timer Function before 15 minutes time frame, press key A again.

■ **FUNCTION KEYS: (Fig. 12, Fig. 17)**

A == Infrared Remote Control  
B == Off  
C == Speed 1/ “-” Control  
D == Speed 2/ “+” Control  
E == Light

By pressing key C or D individually, the speed for each key will be the same as above table. At the same time indication light will flash on the each function key button. To stop the speed function press key B.

If Speed 3 is required, press key D and adjust “+” . At Speed 3 program both key C and key D indication light will flash on each function key button.

To on the light press key E. To off the light press key E again.

■ **FUNCTION KEYS: (Fig. 13, Fig. 18)**

A == Infrared Remote Control  
B == Automatic Stop Timer —15minutes  
C == Speed 1/ “-” Control

D == Speed 2/ “+” Control  
E == Light

By pressing key C or D individually, the speed for each key will be the same as above table. At the same time indicated light will flash on the each function key buttons. To stop the speed function press key B. If using Remote Control just press the “OFF” button. If Speed 3 is required, press key D and adjust “+”. At Speed 3 program both key C and key D indication light will flash on each function key button. If Speed 4 function is available, when Speed 4 function is ON key C and D indication light will flash. If using Remote Control press the “” key.

To on the light press key E. To off the light press key E again.  
When the appliance and light are ON together or separately, press key A the Automatic Stop Timer will start the 15 minutes count down. Indication light on the key A button will flash for the duration. To stop the Automatic Stop Timer Function before 15 minutes time frame, press key A again.

#### • FUNCTION KEYS :( Fig.14)

A= Filtering system / Set clock  
B= Delay Timer  
C= Speed S1/ “-” adjust / off  
D= Digital display  
E= Speed S1/ “+” adjust / off  
F= Alarm  
G= Light



When the Key A is flashing, at the same time “” is flashing on the digital display, it reminds the user to clean the filters. After the filter has been cleaned assemble back. Press key A till the light is off and the unit is back to setting function again.

When pressing key A for 3 seconds, the clock “:00” on the digital display will flash, press key A to switch the mode function to set hours and minutes, and then press key C or E to set the correct time. The Clock’s system is 24 hours.

When the motor is on, press key B the light will on. At the same time “ 0:15” will flash on the digital display, and to press key B to switch the function mode to set hours and minutes. To set the time to automatically shut off, key C or E has to be pressed. Press key B for 3 seconds to stop the delay timer.

Press key C or E, to start the first speed, and it shows “” on the digital

display, and to press key C once again to turn off. To run the 2<sup>nd</sup>, 3<sup>rd</sup> and “Turbo” speed, press Key E. If the “Turbo” speed is on, press key E once again to turn off; and by pressing key C the speed can be adjusted down from 3<sup>rd</sup>, 2<sup>nd</sup> and 1<sup>st</sup>. On the special function setting mode, after the speed “TURBO” runs for 2 minutes it will automatically switch to 3<sup>rd</sup> speed.

Press key F light will flash, and it shows “   : 15 ” flashing on the digital display, to press key F again to switch to set hours and minutes mode. To set the alarm press key C or E. To stop the alarm, press the key F. And to cancel the alarm set, press the key F for 3 seconds.

Press key G light will on, and symbol “  ” display on the digital screen, and press key G again to turn off the light.

•**FUNCTION KEYS:** (Fig.15)

A= Timer (automatic shut off)

B= Speed 1 / adjust / switch off

C= digital display screen (showing timer and speed)

D= Speed 3 / adjust / switch off

E= Light

When key A is being pressed, digital display screen will show "15 minutes" for timer whereas the minutes can be adjusted by pressing "+" or "-" on key B and D. When the first speed is on, pressing key A once to switch off, the digital display will shows "00" on the screen.

When key B is being pressed, it shows "F1" on the digital display screen at the same time first speed is on. By pressing key B again to switch off, the digital display will show "00" on the screen.

When key D is being pressed, it shows "F3" on the digital display screen at the same time the third speed is on. By pressing key D again to switch off, the digital display will show "00" on the screen.

The second speed F2 and Turbo speed F4 can be adjusted by pressing key B or D. When key E is being pressed, the light will on, by pressing key E again is to switch off the light.

If the motor and light are operating together or only the motor is working, pressing key A, automatic switch off timer mode will get on. In other word the

unit will delay 15 minutes to turn off the motor and the light. To press key B or key D is to adjust the time, whereas to press key A again is to stop the timer.

■ **FUNCTION KEYS:** (Fig. 16, Fig. 18)

A == Infrared Remote Control

B == Timer (Automatic Shut Off)

C == Digital Display (Timer/Speed)

D == Speed F1/Cycle Control Adjustment/Off

E == Light

When key B is pressed, digital display screen will display 15 minutes. For cycle control adjustment and Speed F1 press key D. To stop the operation press key B again the digital display screen will show 00. If using remote control press “OFF” button.

When key D is being pressed, the digital display screen will show F1 and speed 1 will ON. To stop F1 function press key D until the digital display screen shown 00.

The F2, F3 Or F4 (Turbo) function can be adjusted thru key D.

For ON/OFF light press key E.

When the appliance and light are ON together or separately, press key B the Automatic Stop Timer will start the 15 minutes count down. Key D can also be used to extend the time of Automatic Stop Timer. To stop the Automatic Stop Timer Function before 15 minutes time frame, press key B again.

### Troubleshooting

<b>Problem</b>	<b>Possible reason</b>	<b>Solution</b>
Hood doesn't work	Electric supply	Check whether the plug is connected
		Check whether the main switch is turned on
Poor airflow	Aluminum grease filters clogged	Clean the filters, assembly back when dry
	Charcoal filters clogged	Replace the charcoal filters
Motor running without air flow	Butterfly valve jammed	Contact technician
After running for a while, motor stop working	High temperature safety device activated	The kitchen is not sufficiently ventilated
	The hood is being installed too near to the cooking stove	The hood must be least 65cm of distance from the stove

Strong cooking smell	Charcoal filters do not install	In re-circulating mode, charcoal filters must be installed
Oil dripping onto stove	Oil cup missing or not installed	Replace aluminum filter and replace oil cup
	Aluminum grease filter saturated	Wash the aluminum grease filters
Whirring sound	Fan blade problem	Contact with technician

**THE MANUFACTURORY DECLINES ALL RESPONSIBILITY FOR EVENTUAL DAMAGES CAUSED BY BREACHING THE ABOVE WARNINGS.**



#### **Correct Disposal of this product**

**This marking indicates that this product should not be disposed with other household wastes throughout the EU. To prevent possible harm to the environment or human health from uncontrolled waste disposal, recycle it responsibly to promote the sustainable reuse of material resources. To return your used device, please use the return and collection systems or contact the retailer where the product was purchased. They can take this product for environmental safe recycling.**

#### **Warranty Information**

**The manufacturer provides warranty in accordance with the legislation of the customer's own country of residence, with a minimum of 1 year (Germany: 2 years), starting from the date on which the appliance is sold to the end user.**

**The warranty only covers defects in material or workmanship.**

**The repairs under warranty may only be carried out by an authorized service centre. When making a claim under the warranty, the original bill of purchase (with purchase date) must be submitted.**

**The warranty will not apply in cases of:**

- Normal wear and tear**
- Incorrect use, e.g. overloading of the appliance, use of non-approved accessories**
- Use of force, damage caused by external influences**
- Damage caused by non-observance of the user manual, e.g. connection to an unsuitable mains supply or non-compliance with the installation instructions**
- Partially or completely dismantled appliances**