

# WYNDHAM COLLECTION

- Prior to installation please check received items against the "Packing List". Please report any missing items to your retailer immediately.
- Protect all surfaces from sharp objects, high heat sources, direct prolonged sunlight and chemical hazards.
- Professional installation recommended.

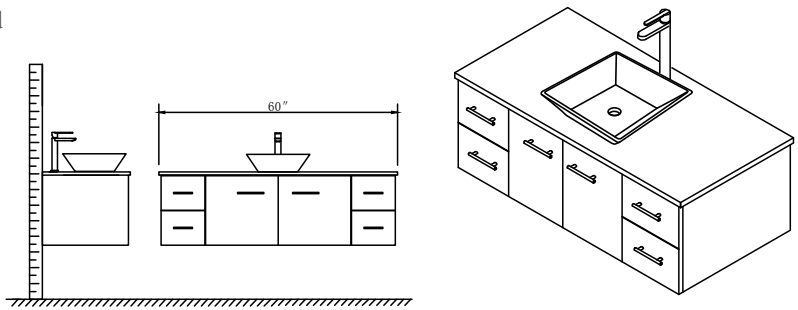

## PACKING LIST

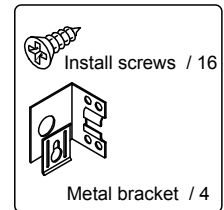
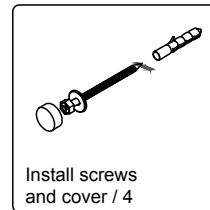
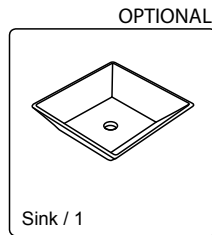
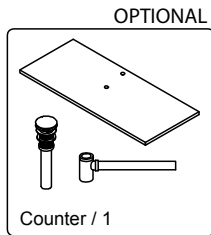
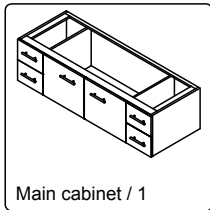

## INSTALLATION AND ADJUSTMENT OF HINGES

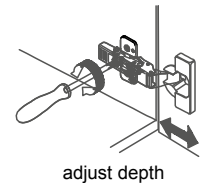
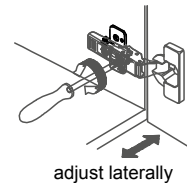
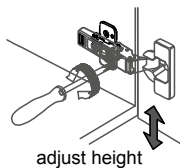
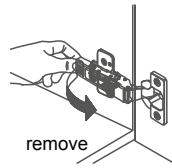
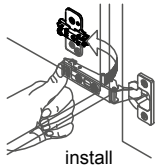

## REQUIRED TOOLS NOT IN BOX

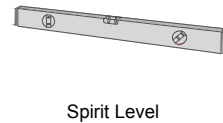
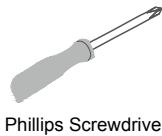
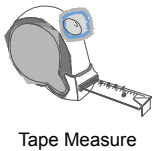

## INSTALLATION INSTRUCTIONS

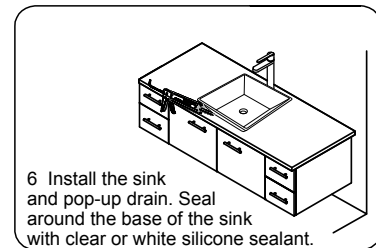
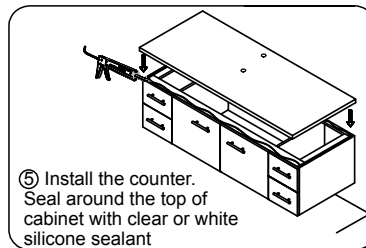
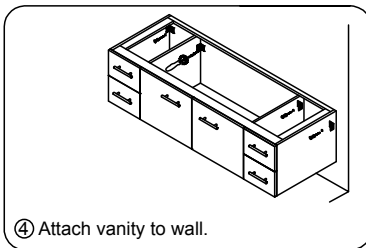
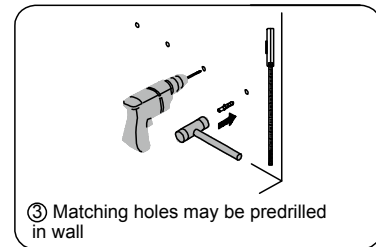
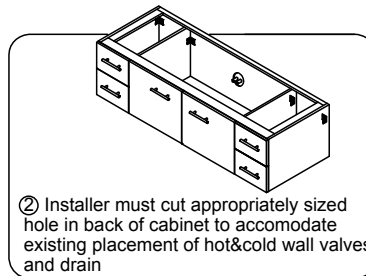
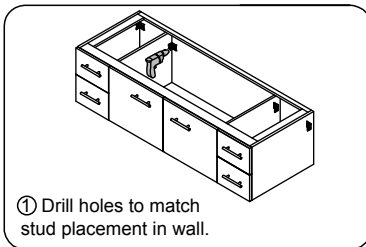

# WC-WHE009-60-SGL Overmount Installation Guide