

# WYNDHAM COLLECTION

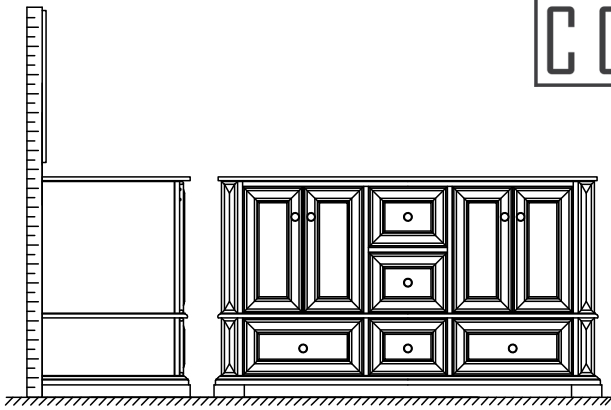

- Prior to installation, please check received items against the "Packing List". Please report any missing items to your retailer immediately.
- Protect all surfaces from sharp objects, high heat sources, direct prolonged sunlight and chemical hazards.
- Professional installation recommended.

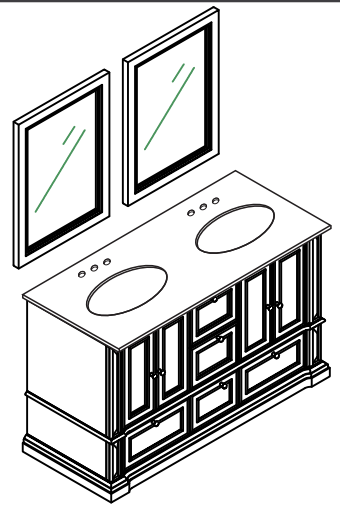

## PACKING LIST

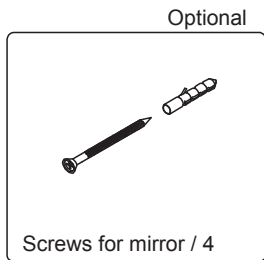
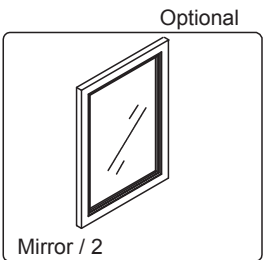
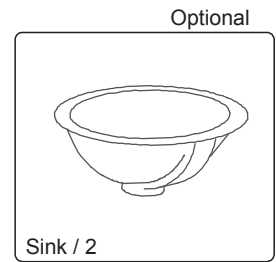
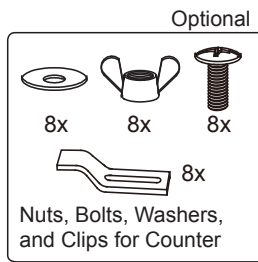
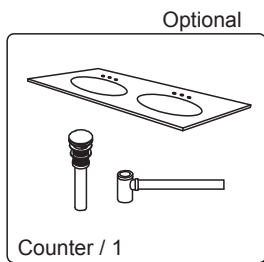
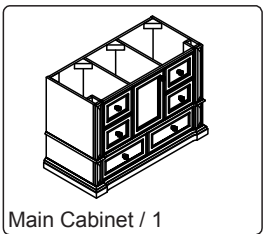

## REQUIRED TOOLS NOT IN BOX

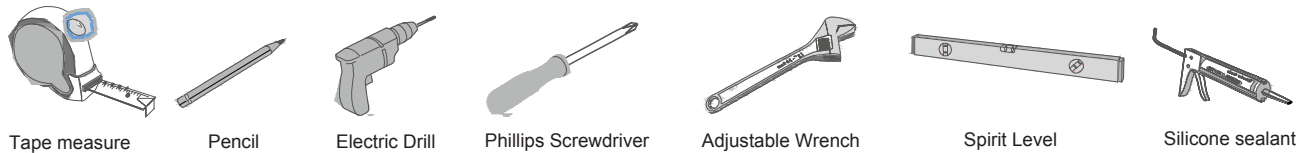

## ADJUSTMENT OF HINGES (if required)

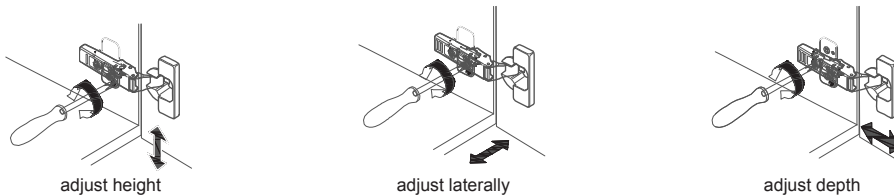

WC-J231-60  
INSTALLATION

# WYNDHAM COLLECTION

## INSTALLATION INSTRUCTIONS

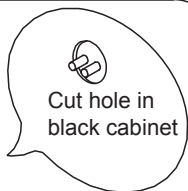
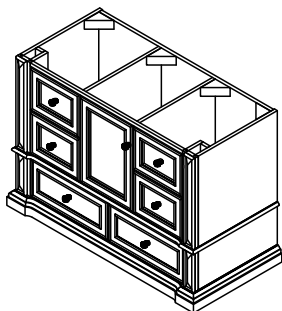

- ① Installer must cut appropriately sized hole in back of cabinet to accommodate existing placement of hot and cold wall valves and drains

②



Apply a continuous bead of quality sealant to the top surface (rim) of the sink.

③

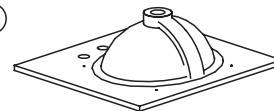

Turn the stone top upside down and place it on a clean, surface. Center the sink over the cutout.

④

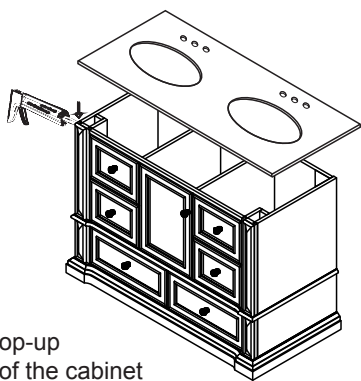
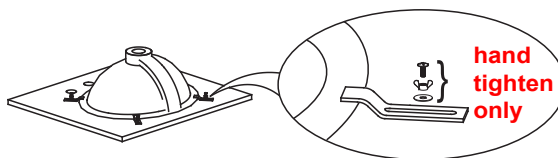

- ⑤ Install the counter and pop-up drain. Seal around the top of the cabinet with clear or white silicone sealant.

⑥

Attach mirror brackets to wall with supplied screws. Hang mirrors.

WC-J231-60  
INSTALLATION