

WYNDHAM COLLECTION

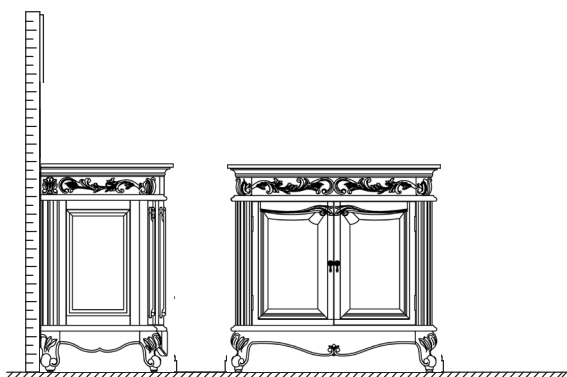

- Prior to installation, please check received items against the "Packing List". Please report any missing items to your retailer immediately.
- Protect all surfaces from sharp objects, high heat sources, direct prolonged sunlight and chemical hazards.
- Professional installation recommended.

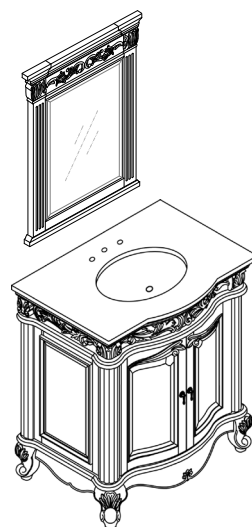

PACKING LIST

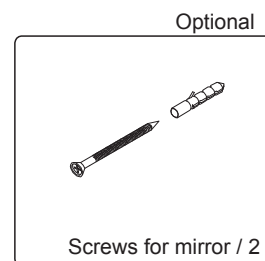
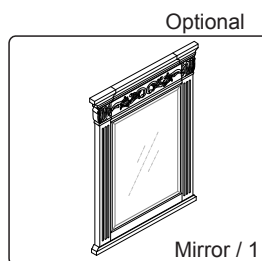
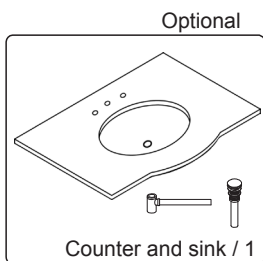
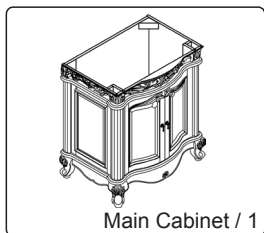

REQUIRED TOOLS NOT IN BOX

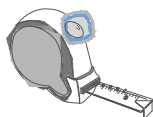

Tape measure

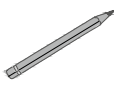

Pencil

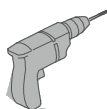

Electric Drill

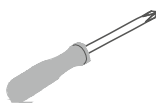

Phillips Screwdriver



Adjustable Wrench

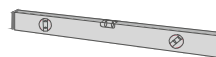

Spirit Level

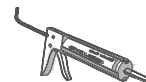

Silicone sealant

WC-J233-36-SGL
INSTALLATION

WYNDHAM COLLECTION

INSTALLATION INSTRUCTIONS

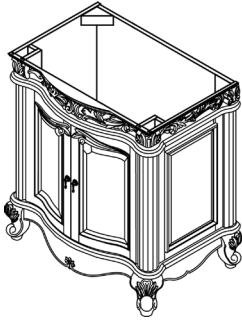

- ① The cabinet is precut in the back for easy plumbing installation. For non-standard installations, installer must cut appropriately sized hole in back to accommodate.

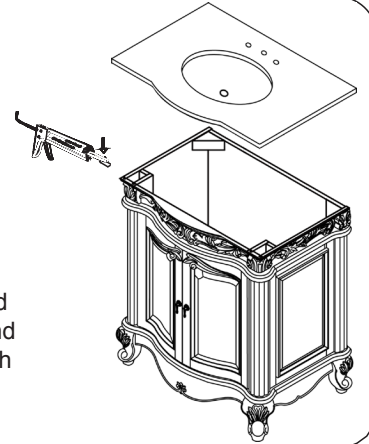

- ② Install the counter and pop-up drain. Seal around the top of the cabinet with clear or white silicone sealant.

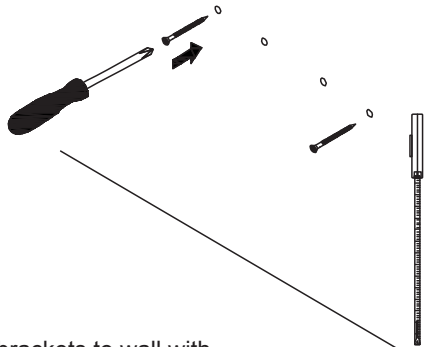

- ③ Attach mirror brackets to wall with supplied screws. Hang mirrors.

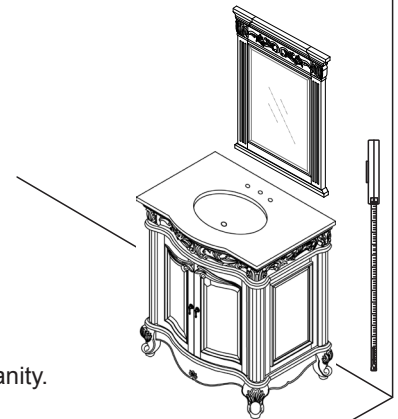

- ④ Enjoy your new vanity.

WC-J233-36-SGL
INSTALLATION