

WYNDHAM COLLECTION

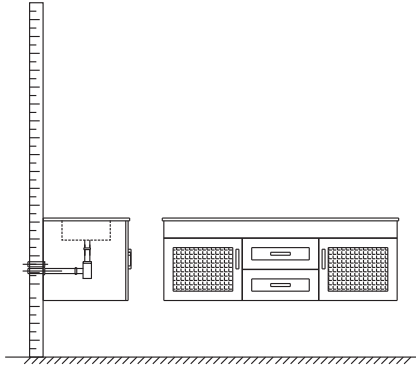

- Professional installation recommended.
- Prior to installation please check received items against the "Packaging List". Please report any missing items to your retailer immediately.
- Protect all surfaces from sharp objects, high heat sources, direct prolonged sunlight and chemical hazards.

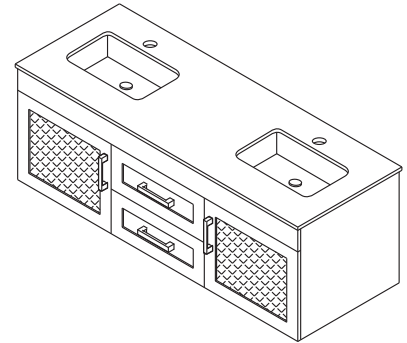

PACKING LIST

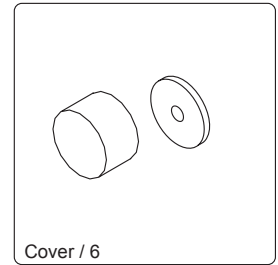
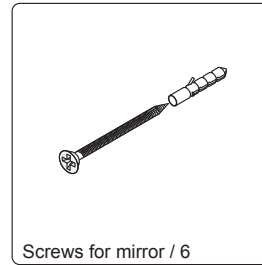
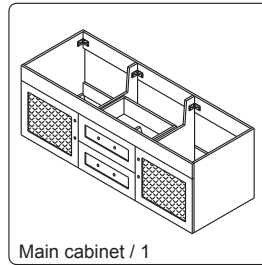
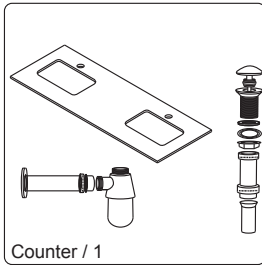

INSTALLATION AND ADJUSTMENT OF HINGES (if required)

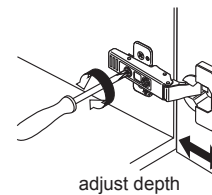
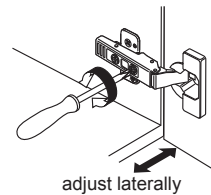
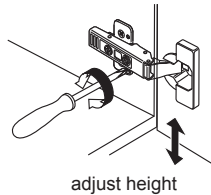
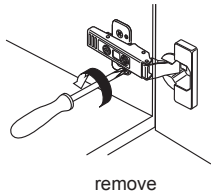
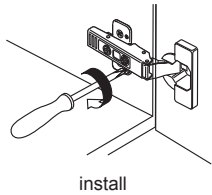

REQUIRED TOOLS NOT IN BOX

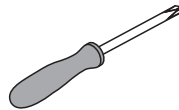
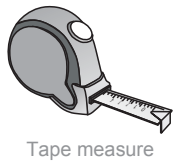

INSTALLATION INSTRUCTIONS

Please use appropriate glue to secure sink to counter. Professional installation recommended.

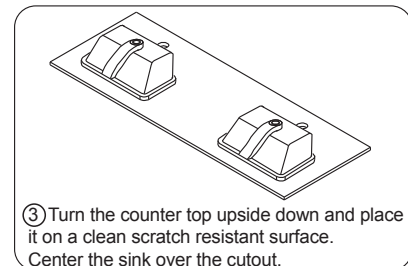
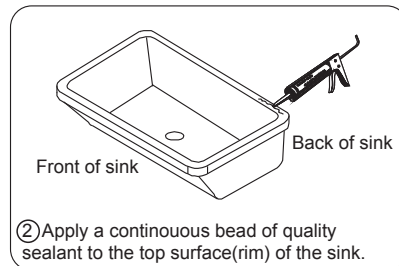
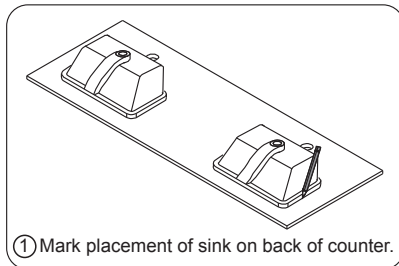

WC-B051-72
INSTALLATION

WYNDHAM COLLECTION

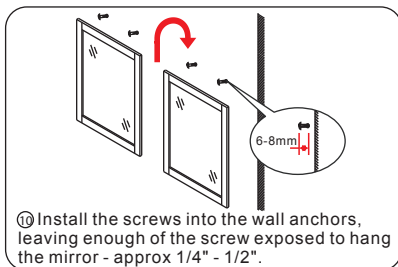
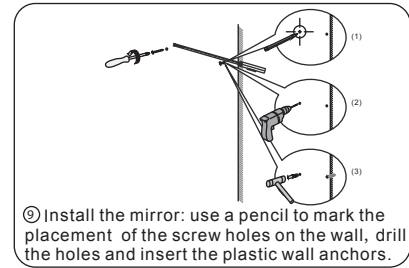
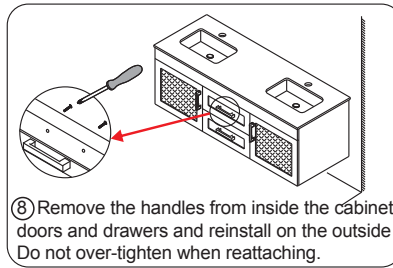
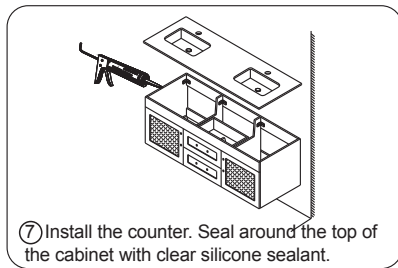
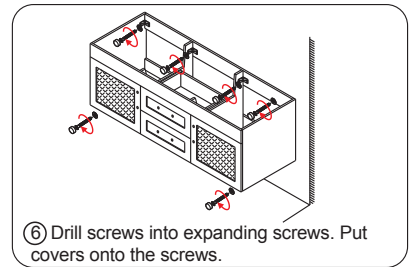
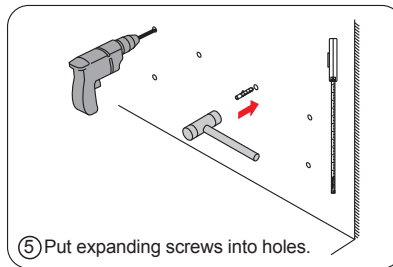
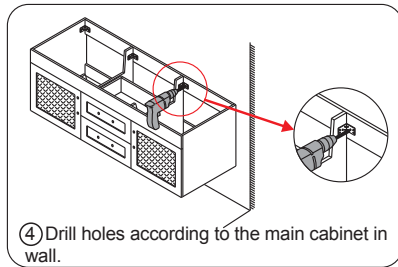

WC-B051-72
INSTALLATION