

TIKAL – model: G915

Cosmopolitan Collection Glass Pendant

WAC LIGHTING
Responsible Lighting®

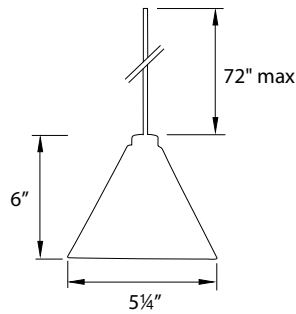

Fixture Type:

Catalog Number:

Project: _____

Location: _____

PRODUCT DESCRIPTION

Enhance a modern or transitional setting with lovely frosted glass designed with Mayan accents. The charming Tikal mini pendant is crafted in Germany with a half-frosted and half-clear glass shade that gently diffuses the inner bulb's light source while revealing a unique look.

FEATURES

- Low voltage xenon lamping
- Can be used on canopies, all Quick Connect™ systems and line voltage rail and track systems
- All socket sets include 72" wire that may be cut in the field
- 5 year WAC Lighting product warranty
- UL & CUL Listed

CONSTRUCTION

- **Socket Set:** Machined Aluminum
- **MP Canopy:** Steel
- **Adapters – Solorail™, Duorail™:** Copper
- **Adapters – 120V Track, Flexrail 1:** Polycarbonate

COMPATIBLE SYSTEMS

Canopy (MP)

Low Voltage xenon lamp

Includes:

- Shade
- Quick Adjust™ Canopy (shown)
- Socket Set
- Lamp



The patent pending Quick Adjust™ Canopy has an adjustable cable that stores inside the canopy housing for easy in-field height adjustments.

Sold as a complete unit with a single Order Number, no adapters needed.

Quick Connect™ (QP)

Low Voltage xenon lamp

Includes:

- Shade
- Threaded Male Connector (shown)
- Socket Set
- Lamp



For use on 120V Track, Solorail™, Duorail™, and Flexrail 1™ with proper Quick Connect™ adapter (sold separately).

Can also be used on any Quick Connect™ Canopy (sold separately) no adapter needed.

Threaded Male Connector easily joins with all Quick Connect™ Adapters and Canopies.

For Lamp Specifications and Ordering Information see next page.

WAC Lighting

www.waclighting.com

Phone (800) 526.2588 • Fax (800) 526.2585

Headquarters/Eastern Distribution Center

44 Harbor Park Drive • Port Washington, NY 11050

Phone (516) 515.5000 • Fax (516) 515.5050

Western Distribution Center

1750 Archibald Avenue • Ontario, CA 91760

Phone (800) 526.2588 • Fax (800) 526.2585

TIKAL – model: G915

Cosmopolitan Collection Glass Pendant

WAC LIGHTING
Responsible Lighting®

SOCKET SET and LAMP INFORMATION

Low Voltage

Lamp: 12V Xenon BP-50 (included)

Power: 50W max

- May be dimmed
- Includes collar with threaded set screw to allow for varying lamp positions inside the shade
- DO NOT rest glass on socket base
- Includes 12V, 50W xenon bi-pin

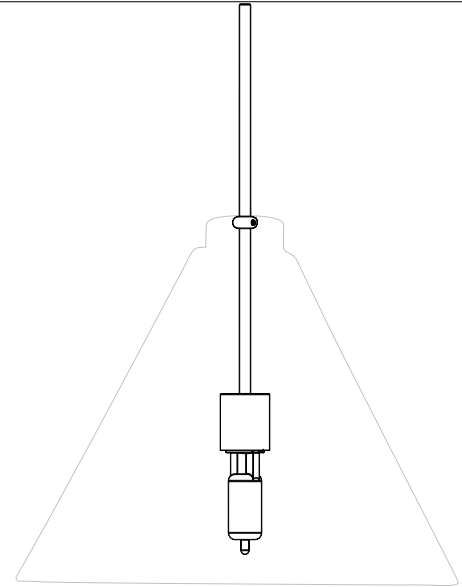

System	Model	Lamping	Shade Finish	Socket Finish
MP <i>Canopy</i>	915	<i>Xenon</i>	CF <i>Clear Frosted</i>	BN <i>Brushed Nickel</i>
QP <i>Quick Connect™</i>				CH <i>Chrome</i>
				DB <i>Dark Bronze</i>

Example: **QP915-CF/CH**

Canopy models (MP) include Quick Adjust™ canopy
Quick Connect™ (QP) models require additional adapter

System Model # Color Finish

- /

Example: **QP915-CF/CH**

SOCKET FINISHES

BN - Brushed Nickel



CH - Chrome



DB - Dark Bronze



WAC Lighting
www.waclighting.com
Phone (800) 526.2588 • Fax (800) 526.2585

Headquarters/Eastern Distribution Center
44 Harbor Park Drive • Port Washington, NY 11050
Phone (516) 515.5000 • Fax (516) 515.5050

Western Distribution Center
1750 Archibald Avenue • Ontario, CA 91760
Phone (800) 526.2588 • Fax (800) 526.2585





TIKAL – model: G915

Cosmopolitan Collection Glass Pendant

WAC LIGHTING

Responsible Lighting®

QUICK CONNECT™ ADAPTERS (order one per fixture)

Solorail™	Model #	Finish	Duorail™	Model #	Finish
	LM-QADP	BN CH DB		LM2-QADP	BN CH DB
Flexrail1™	Model #	Finish	120V Track	Model #	Finish
	HM1-EN50	DB PT		EN-LQ50AR EN-HQ50AR EN-JQ50AR	BK BN DB WT

ORDER NUMBER



Model # – Finish

Example: **LM-QADP-BN**

QUICK CONNECT™ CANOPIES with INTEGRAL DRIVER

			
Model # QMP-60ERN	Model # QMP-G1RN	Model # QMP-G3RN	Model # QMP-G3RE
Finish BN CH DB	Finish MR	Finish MR	Finish MR

QUICK CONNECT™ CANOPIES for use with REMOTE TRANSFORMER

		
Model # QMP-MI-TR	Model # QMP-1RN-TR	Model # QMP-1SQ-TR
Finish BN CH DB	Finish BN CH DB	Finish BN CH DB

ORDER NUMBER

Model # – Finish

Example: **QMP-60ERN-BN**

FINISHES

BK - Black	BN - Brushed Nickel	CH - Chrome	DB - Dark Bronze	MR - Mirror	PT - Platinum	WT - White
						

WAC Lighting
www.waclighting.com
Phone (800) 526.2588 • Fax (800) 526.2585

Headquarters/Eastern Distribution Center
44 Harbor Park Drive • Port Washington, NY 11050
Phone (516) 515.5000 • Fax (516) 515.5050

Western Distribution Center
1750 Archibald Avenue • Ontario, CA 91760
Phone (800) 526.2588 • Fax (800) 526.2585