

# ASSEMBLY AND INSTALLATION INSTRUCTIONS

T0127

**WARNING:** TO AVOID RISK OF ELECTRICAL SHOCK, BE SURE TO SHUT OFF POWER WHILE INSTALLING OR SERVICING THIS FIXTURE.

**NOTES:** 1. Before installing, consult local electrical codes for wiring and grounding requirements.  
2. Read and save these instructions.

## Important to Know

1. Read all instructions carefully before installation and operation.
2. If you are not familiar with state and local electrical codes, it is recommended that you consult with a qualified electrician.
3. Before installation, shut off power at the main fuse or circuit breaker box. Be aware that simply turning off the wall switch is not sufficient to prevent an electrical shock.
4. This fixture requires a 120V AC, 60 Hz power source.
5. Do not attempt to take the lantern apart; there are no serviceable parts inside.
6. To avoid sensor damage by lightning or electrical surge, make sure the grounding wire is securely connected.
7. For general safety and to avoid any possible damage to the sensor, be sure the power is switched "off" before replacing the bulb.

**Maximum Wattage: 100W Incandescent bulb**

**Work Temperature: -4°F ~ 104°F**

## Features

1. Energy saving fixture.
2. Use the dim-to-bright illumination option where you want some minimum illumination through out the night, such as at your front entrance or garage door. Use the dark-to-bright illumination option where you do not need minimum brightness, such as the backyard or back porch.
3. When in manual override mode, use wall switch to keep the light ON till dawn.

## Hardware Package (included):

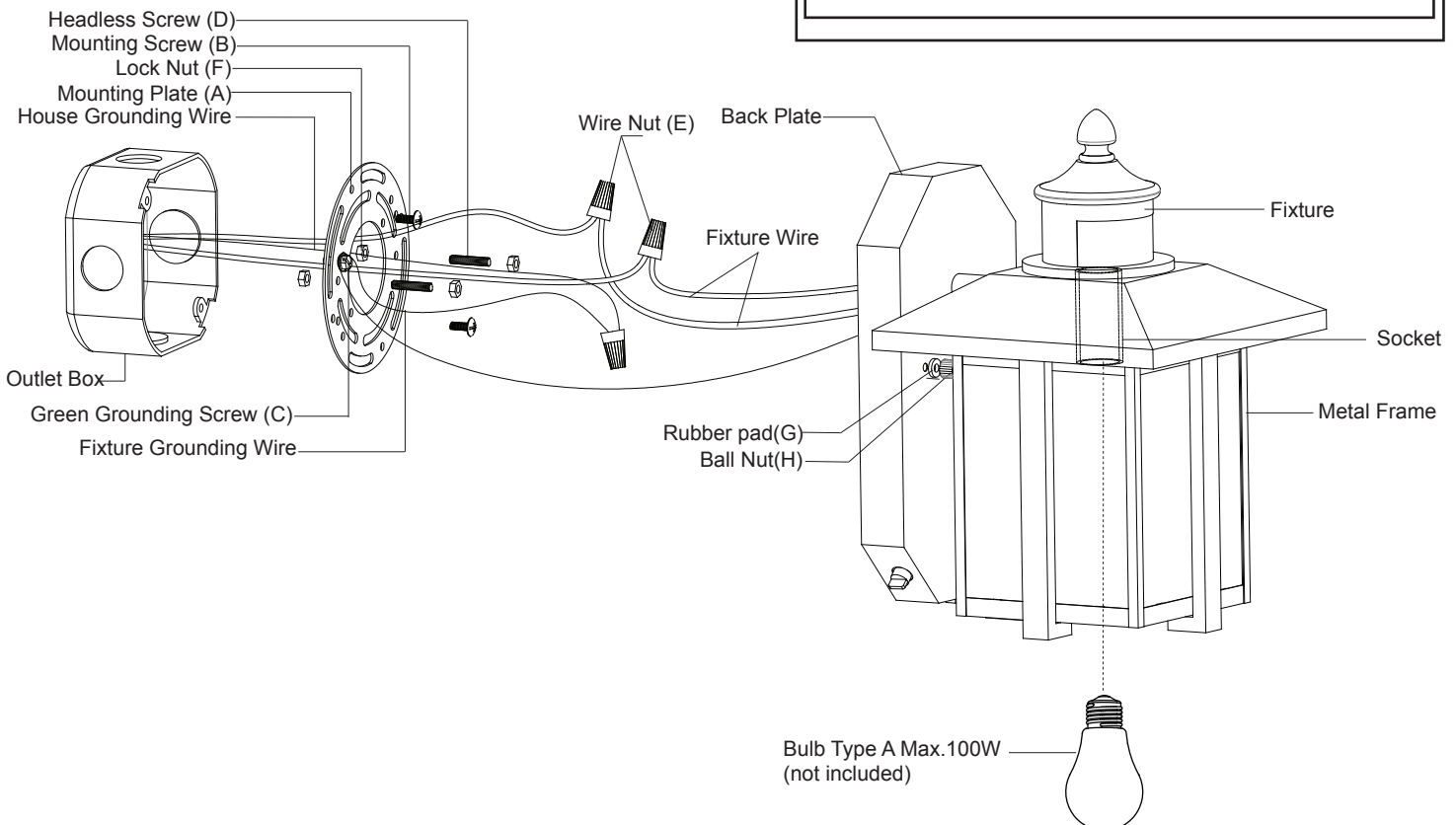
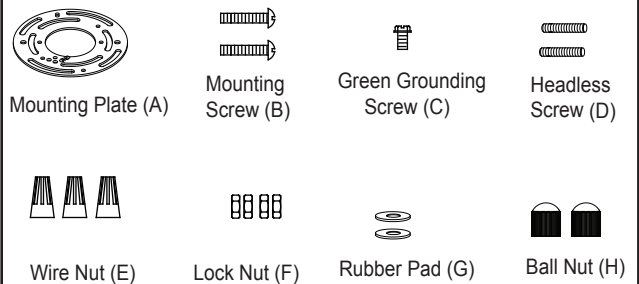

 **VAXCEL**

141208

## Installation Steps

Turn off the power at fuse or circuit box.

1. Thread two headless screws through the mounting plate, then secure them with four lock nuts (two on each side of the mounting plate). Adjust the length of the headless screws if necessary.  
Note: Make sure that the headless screws are lined up horizontally, to ensure that the fixture will be level.
2. Attach the mounting plate to the outlet box by using two mounting screws.
3. Pull out the wires and grounding wire from the outlet box. Make wire connections using the wire nuts as follow:  
---Connect the hot wire (usually black insulation) from the fixture to the black wire from the power source.  
---Connect the neutral wire (usually white insulation) from the fixture to the white wire from the power source.  
---Attach the fixture grounding wire (usually green insulation or bare wire) to the mounting plate with the green grounding screw. Then connect it to the house grounding wire with the wire nut.  
Carefully put the wires back into the outlet box.
4. Attach the back plate to the mounting plate by inserting the headless screws, then secure it with two rubber pads and two ball nuts.  
**CAUTION: With silicone caulking compound, caulk completely around where the back plate meets with the wall surface to prevent water from seeping into the outlet box.**
5. Install bulb (not included). See relamping label at socket area or packaging for maximum allowed wattage.

Turn on the power at fuse or circuit box.

## Function and Operation

### MODES OF OPERATION

Choose a mode by sliding the switch on the bottom of the back plate of the fixture. (See FIG.2 on page 3).

When power is first applied, the light will turn to high level brightness, wait for 15 seconds to allow the sensor to warm up.

1. TEST MODE (daytime and nighttime operation)
  - The light will turn to low-level brightness (0%~50% brightness). The light will turn to high-level brightness (100% brightness) when motion is detected, and stay on as long as the motion is continuing. The light will revert to low-level brightness about 5 seconds after motion is no longer detected.
2. 3H MODE (nighttime operation only)
  - At dusk, the light will turn to high-level brightness (100% brightness). The light will turn to low-level brightness (0% ~50% brightness) automatically after 3 hours. The light will turn to high-level brightness (100% brightness) when motion is detected, and stay on as long as the motion is continuing. When motion is no longer detected, the light will remain on for the predetermined time you set (5~180 seconds), and then revert to low-level brightness you set.
  - Light will turn off automatically at dawn, and return to 3 H mode at dusk.
3. 6H MODE (nighttime operation only)
  - At dusk, the light will turn to high-level brightness (100% brightness). The light will turn to low-level brightness (0% ~50% brightness) automatically after 6 hours. The light will turn to high-level brightness (100% brightness) when motion is detected, and stay on as long as the motion is continuing. When motion is no longer detected, the light will remain on for the predetermined time you set (5~180 seconds), and then revert to low-level brightness you set.
  - Light will turn off automatically at dawn, and return to 6 H mode at dusk.
4. 0 MODE (nighttime operation only)
  - The light will turn to low level brightness (0%~50% brightness) at dusk. The light will turn to high-level brightness (100% brightness) when motion is detected, and stay on as long as the motion is continuing. When motion is no longer detected, the light will remain on for the predetermined time you set (5~180 seconds), and then revert to low level brightness you set.
  - Light will turn off automatically at dawn, and return to 0 H mode at dusk.

5. Manual Override MODE (nighttime operation only; on at dusk, off at dawn)

- In 3, 6 or 0 mode, to shift to manual override mode, turn off the wall switch in 3 seconds and then turn it on again, the light will turn to high-level brightness at dusk, and turn off automatically at dawn. To return to the previous settings, turn off the wall switch in 3 seconds and then turn it on again. (See FIG.2)
- The lights will turn off automatically at dawn.

**Note: You can adjust the low level brightness (0~50%) by using the slide switch on the side of back plate.(See FIG.3)**

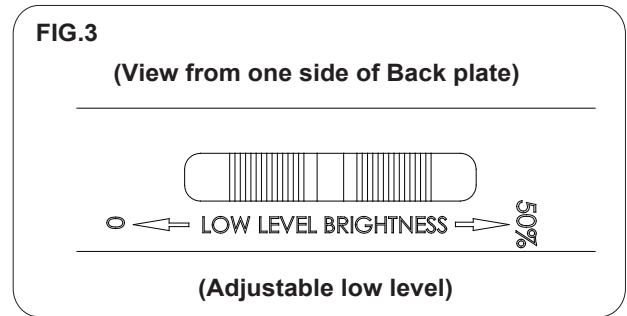
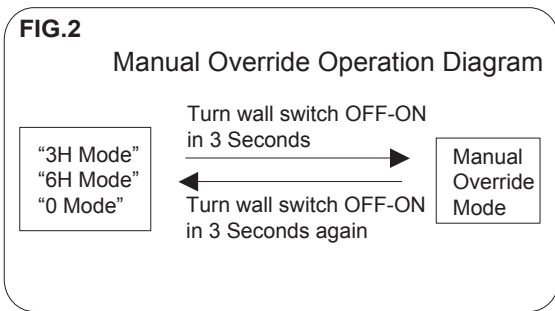

**CUSTOMIZATION OPTIONS:**

**Shut-off Delay**

The Shut-off delay is the length of time the light will stay at high-level brightness after motion has ceased to be detected. This Shut-off delay can be set when operation is in 3, 6 or 0 Mode by using the "TIME" knob located on the left side of the panel at the bottom of the back plate (See FIG. 4) . To increase the shut-off delay, turn the knob clockwise. To decrease shut off delay, turn the knob counterclockwise. The delay may be adjusted from a minimum of 5 seconds to a maximum of 3 minutes. The light will stay on as long as motion is detected continuously and will automatically turn to low-level brightness when no more motion is detected after the delay time has passed.

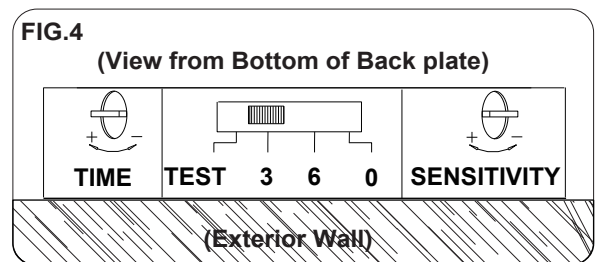

**Sensitivity of Motion Sensor**

The sensitivity of the motion sensor can be adjusted by using the "SENSITIVITY" knob located on the right side of the panel at the bottom of the back plate (See FIG.4). To increase sensitivity, turn the knob clockwise. To decrease sensitivity, turn the knob counterclockwise. The sensitivity may be adjusted from a minimum of 5 feet to a maximum of 40 feet.

**NOTE:**

1. The sensitivity of the motion sensor will increase as the environmental temperature gets cooler. You may wish to make adjustments when the season changes. For best performance, gently clean the lens with a soft cloth every 1 or 2 months to assure maximum sensitivity.
2. For best performance, install fixture at least 6 feet above the ground. At such a height, the fixture will provide a detection distance of up to 40 feet at 77 degrees Fahrenheit. (See FIG.5)
3. The sensor detects across a detection range of 220 degrees. (See FIG.6)
4. The sensor will be more sensitive to motion across its detection path than motion directly towards it. (See FIG.7)
5. To reduce possible nuisances, do not mount the fixture near a heat source like an air conditioner, vent or furnace exhaust, or in a direction facing any reflecting object or other light source.

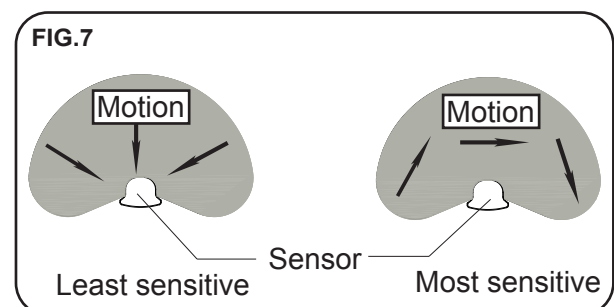
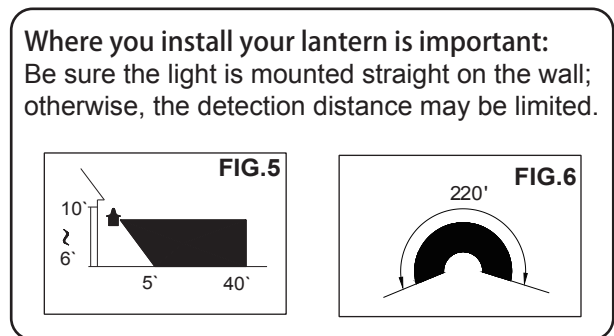

# Troubleshooting

## ---If the light does not work at all:

1. Make sure the wall switch and circuit breaker are on.
2. Make sure the wiring connection is correct.
3. Make sure the bulb is not burned out.
4. Cover the sensor with your palm to verify that the ambient light level is not too high.

## ----In Test Mode, if the light stays on full brightness after 5 seconds:

1. Check whether the motion is detected at all time.

## ----After performing 3H or 6H mode, or in 0 H mode. If the light stays on full brightness after 3 minutes.

1. Make sure no motion could be picked up by the sensor.
2. Make sure that mode entry is not in manual override.

## ----In PC / Manual override Mode, if the light stays on after dawn:

1. Whether the ambient light level is too low.

## ----If the light blinks:

1. Make sure the light is not mounted near a barbecue, air conditioner or other heat source.
2. Make sure of using incandescent bulb or dimmable LED bulb.

The following parts are available for re-order if damaged or missing.

**Spare Parts List:**

Mounting Plate (A)	Mounting Screw (B)	Green Grounding Screw (C)	Headless Screw (D)		Finial 5196FF(1PC)
Wire Nut (E)	Lock Nut (F)	Rubber Pad (G)	Ball Nut (H)	Glass Panel 9656CS(3PCS)	Set Screw 5197SS (2PCS)

## 5-YEAR LIMITED WARRANTY:

All products are warranted to be free of defects in material and workmanship for five (5) years from date of purchase. This warranty is limited to the correction of any such defect, or the replacement of any such defective item(s), provided that: (a) we are properly notified and consent to return of the item(s) in question;(b) the item (s) is / are returned with proof of purchase date; and (c) it is found upon inspection by us that the item (s) is / are defective as noted above. This warranty dose not cover labor costs, consequential damages, nor dose it apply to any item(s) that have been improperly installed, overloaded, altered, or otherwise abused by the customer, its agent(s) or emplyee(s). Finishes are specially excluded from the terms of this warranty since they are subject to environmental maintenance deemed beyond our control. Other than the described obligation, we assume no further liability with respect to the sale or use of our products.We make no warranty, express or implied, and disclaim any warranty of merchantability or fitness for a particular purpose.

