



ilo™ S

The perfect
light in a
FLIP of a
SWITCH

The ilo S is an excellent choice for applications requiring a stand-alone switched fixture.

The built-in on/off switch provides instant illumination for under cabinet, closets and shelving — or simply use it as a night light. With the wire exiting the back, the installed fixture gives the high-end appearance of being built in.

iLo™ S

perfect light in a FLIP of a SWITCH

2.5W/ft

APPLICATIONS

- Under cabinet
- Lecterns
- Desks
- Closets
- RV/BOAT

FEATURES

- Instant on/instant brightness
- Built-in On/Off switch and diffuser
- Available in four lengths (10, 16, 24, 32")
- Aluminum finish (custom finish w/minimum order)
- 90° viewing area
- 2.5 Watts per foot
- 25,000-hour life
- 2700K or 4800K color temperatures
- NOT LINKABLE



79" lead cord included
Wire exits at bottom of fixture



Mounting tab

SPECS

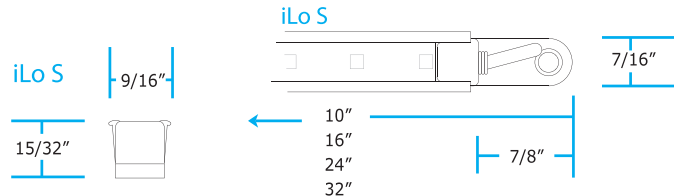

Installation iLo S

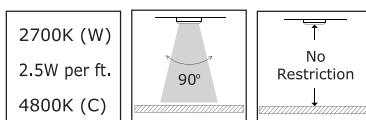
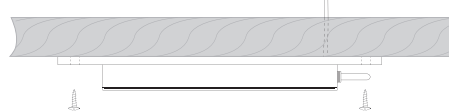

Tresco's ilo L linear strip has been heralded throughout the industry for its energy efficiency, low heat generation and remarkably long life.

It can make a tremendous difference in retail settings, where it can enhance the appearance of items on display and truly show them off in their best light. The ilo L is equally at home in a residential setting, where it can provide uniform illumination to complement the design of any room.



iloTM L

show off
your products

APPLICATIONS

- Under shelving
- Interior cabinet
- Toe kicks
- Display cases
- Wine racks
- Under cabinet

2.5W/ft



Linkable up to 12' continuous run
(24' total per power supply)



- Linking distance is 4"
- There will be no darkened areas between fixtures if unit is installed at height of 18" from surface

iLo™ L

show off
your products

FEATURES

- Instant on/instant brightness
- Built-in diffuser to reduce glare
- Available in six lengths (10, 16, 22, 28, 34, 40")
- Aluminum finish (custom finish w/minimum order)
- Linkable up to 12' continuous run (24' total per power supply)
- 90° viewing area
- 2.5 Watts per foot
- 25,000-hour life
- 2700K or 4800K color temperature



Frosted Diffuser



Male/Female connectors



Mounting tab



SPECS

Installation iLo L

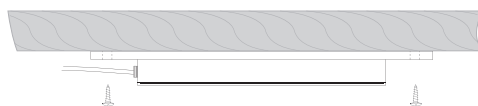

2700K (W)
2.5W per ft.
4800K (C)

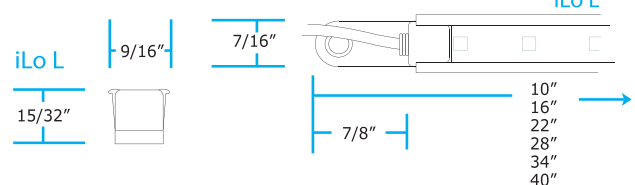
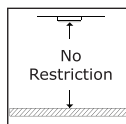
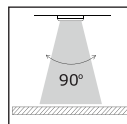



Required Items

Light Fixture – Link Series

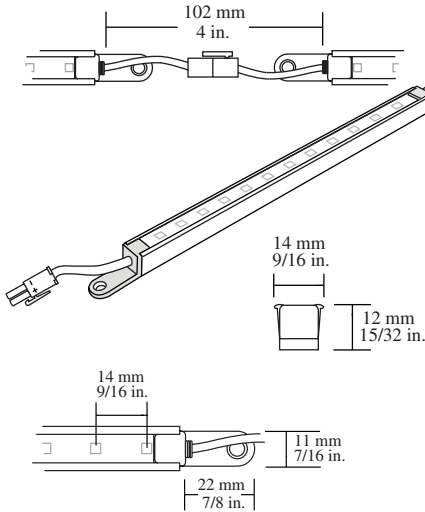

Part #	Description	Suggested List
L-LED-LSP-250WNI-1	250mm (10") ilo L LED, 2700K, Nickel	\$78.90
L-LED-LSP-406WNI-1	406mm (16") ilo L LED, 2700K Nickel	\$108.15
L-LED-LSP-559WNI-1	559mm (22") ilo L LED, 2700K Nickel	\$141.65
L-LED-LSP-711WNI-1	711mm (28") ilo L LED, 2700K Nickel	\$173.30
L-LED-LSP-864WNI-1	864mm (34") ilo L LED, 2700K Nickel	\$214.75
L-LED-LSP-1016WNI-1	1016mm (40") ilo L LED, 2700K Nickel	\$246.35
L-LED-LSP-250CNI-1	250mm (10") ilo L LED, 4800K, Nickel	\$78.90
L-LED-LSP-406CNI-1	406mm (16") ilo L LED, 4800K, Nickel	\$108.15
L-LED-LSP-559CNI-1	559mm (22") ilo L LED, 4800K, Nickel	\$141.65
L-LED-LSP-711CNI-1	711mm (28") ilo L LED, 4800K, Nickel	\$173.30
L-LED-LSP-864CNI-1	864mm (34") ilo L LED, 4800K, Nickel	\$214.75
L-LED-LSP-1016CNI-1	1016mm (40") ilo L LED, 4800K, Nickel	\$246.35

25,000 Useful Life Hours
Maximum continuous run 12 feet to prevent voltage drop. Maximum 24 feet per Power Supply.

Light Fixture – Switch Series

Non-Linkable

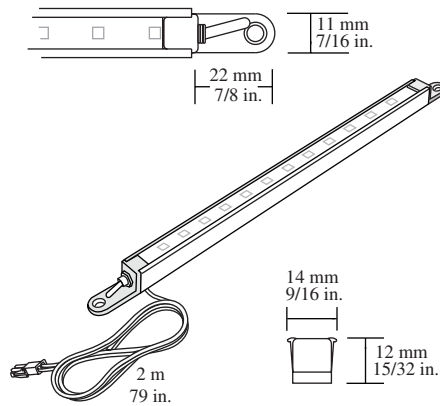

Part #	Description	Suggested List
L-LED-SWLSP-250WNI-1	250mm (10") ilo S LED, 2700K, Nickel	\$54.95
L-LED-SWLSP-406WNI-1	406mm (16") ilo S LED, 2700K, Nickel	\$107.75
L-LED-SWLSP-610WNI-1	610mm (24") ilo S LED, 2700K, Nickel	\$158.80
L-LED-SWLSP-813WNI-1	813mm (32") ilo S LED, 2700K, Nickel	\$211.25
L-LED-SWLSP-250CNI-1	250mm (10") ilo S LED, 4800K, Nickel	\$54.95
L-LED-SWLSP-406CNI-1	406mm (16") ilo S LED, 4800K, Nickel	\$107.75
L-LED-SWLSP-610CNI-1	610mm (24") ilo S LED, 4800K, Nickel	\$158.80
L-LED-SWLSP-813CNI-1	813mm (32") ilo S LED, 4800K, Nickel	\$211.25

25,000 Useful Life Hours
Each Light must plug into Power Supply separately.

DC Power Supply - 60W

Electronic.

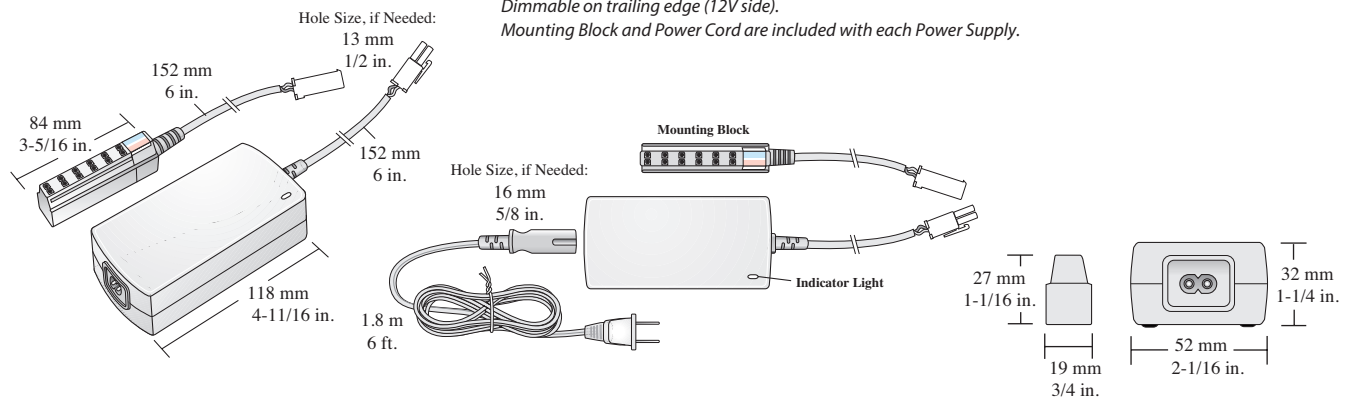

Part #	Description	Suggested List
L-DC-ELT60-CON-1	60W 12VDC Power Supply w/6 Snap Mounting Block	\$73.80

Dimmable on trailing edge (12V side).
Mounting Block and Power Cord are included with each Power Supply.

All product dimensions and specifications are subject to change without prior notice.

ILO™ SERIES LED
STRIP LIGHTING

Required Items

Starter/Link

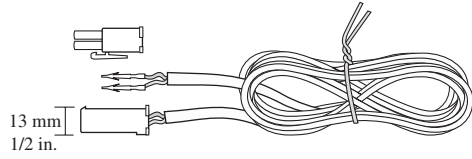

Part #	Description	Suggested List
L-LED-LINKD-15-1	15cm (6") 12VDC Starter/Link/Extension Cord	\$4.05
L-LED-LINKD-25-1	25cm (10") 12VDC Starter/Link/Extension Cord	\$5.95
L-LED-LINKD-60-1	60cm (24") 12VDC Starter/Link/Extension Cord	\$6.65
L-LED-LINKD-120-1	120cm (48") 12VDC Starter/Link/Extension Cord	\$8.25
L-LED-LINKD-180-1	180cm (72") 12VDC Starter/Link/Extension Cord	\$10.00

Required for ilo L Series to connect run of Lights to Power Supply. Purchased separately.

Optional Items

Touch On/Off Switch

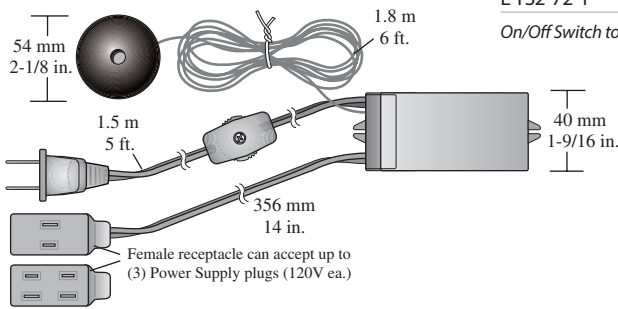

Female receptacle can accept up to (3) Power Supply plugs (120V ea.)

Part #	Description	Suggested List
L-TS2-72-1	Touch On/Off w/Cord And Touch Pad. Black.	\$48.45

On/Off Switch touch pad attaches to surface with adhesive backing. Power Supply plugs into On/Off Switch.

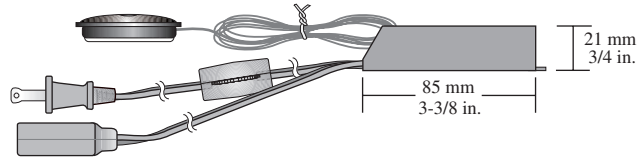

Round Switch - 12V

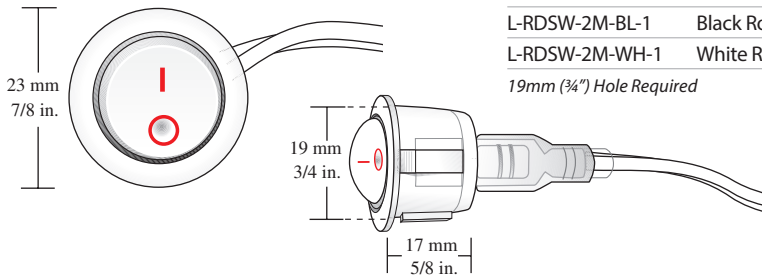

Part #	Description	Suggested List
L-RDSW-1M-BL-1	Black Rocker Switch w/1m (39") Lead, 12VAC/DC	\$16.40
L-RDSW-1M-WH-1	White Rocker Switch w/1m (39") Lead, 12VAC/DC	\$16.40
L-RDSW-2M-BL-1	Black Rocker Switch w/2m (79") Lead, 12VAC/DC	\$18.40
L-RDSW-2M-WH-1	White Rocker Switch w/2m (79") Lead, 12VAC/DC	\$18.40

19mm (3/4") Hole Required

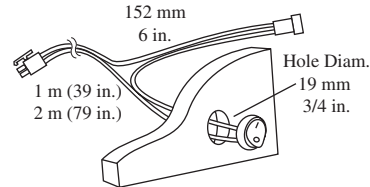

Roll Switch - 120V

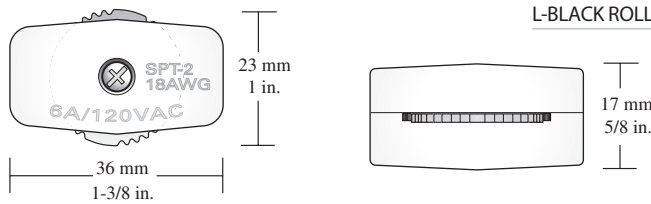

Part #	Description	Suggested List
L-WHITE ROLL SWITCH-1	120V White Roll Switch	\$2.45
L-BLACK ROLL SWITCH-1	120V Black Roll Switch	\$2.45

Remote Control LED Dimmer - 12V

w/ 2 Remote Controls

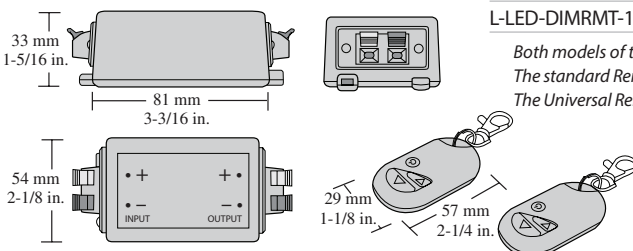

Part #	Description	Suggested List
L-LED-DIMRMT-12V8A-1	LED Dedicated Remote Control Dimmer, 12VDC 96W	\$80.05
L-LED-DIMRMT-12V8A-U-1	LED Universal Remote Control Dimmer, 12VDC 96W	\$80.05

Both models of the Remote Control LED Dimmer provide on/off power and dim lights from 1%–100%. The standard Remote Control independently controls one specific Dimmer in a room with other Dimmers. The Universal Remote Control (U) controls multiple Dimmers in a room.

All product dimensions and specifications are subject to change without prior notice.

Optional Items

Manual Rotary Dimmer

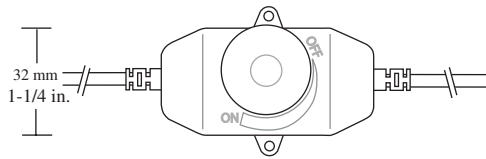

Part #	Description	Suggested List
L-LED-DIMCON-BL-1	LED Black Inline Rotary Dimmer, 12VDC 48W	\$50.05
L-LED-DIMCON-WH-1	LED White Inline Rotary Dimmer, 12VDC 48W	\$50.05

The Manual Rotary Dimmer provides on/off power and dims lights from 1%-100%.

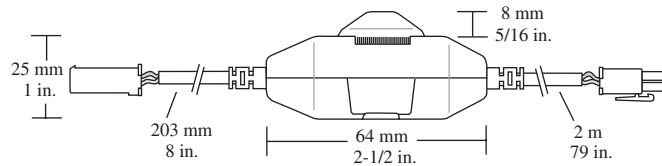

AMP® Connector

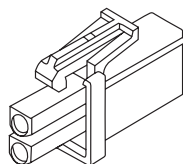

Part #	Description	Suggested List
L-MALE AMP	AMP® Connector for Light Fixture	\$10.15

AMP® Connector is included with each Light Fixture.

Starter/Link

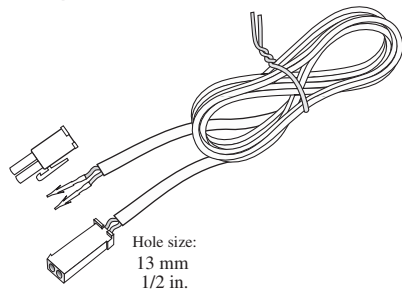

Part #	Description	Suggested List
L-LED-LINKD-15-1	15cm (6") 12VDC Starter/Link/Extension Cord	\$4.05
L-LED-LINKD-25-1	25cm (10") 12VDC Starter/Link/Extension Cord	\$5.95
L-LED-LINKD-60-1	60cm (24") 12VDC Starter/Link/Extension Cord	\$6.65
L-LED-LINKD-120-1	120cm (48") 12VDC Starter/Link/Extension Cord	\$8.25
L-LED-LINKD-180-1	180cm (72") 12VDC Starter/Link/Extension Cord	\$10.00

For ilo L Series only. Use to link Light Fixture to Light Fixture when desired spacing is greater than 4 inches. 13 mm (1/2 in.) Hole Required

Magnet Switch Kit - 12V

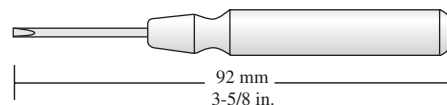
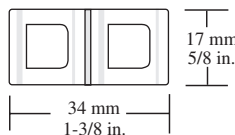
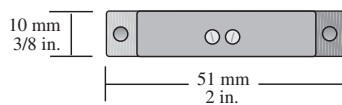

Wire manage clips with adhesive backing

Part #	Description	Suggested List
L-AUSW-MAG-BR-1	Brown Automatic Magnet Door Switch, 20W Max	\$27.55
L-AUSW-MAG-WH-1	White Automatic Magnet Door Switch, 20W Max	\$27.55

Control Modules

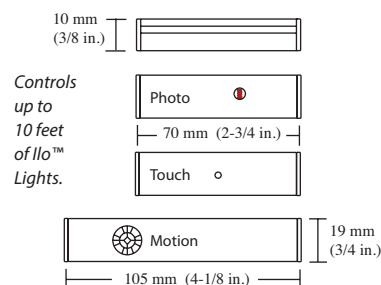

Controls up to 10 feet of ilo™ Lights.

Part #	Description	Suggested List
L-LED-SMPMOT-1	27W SimpLED Inline Motion Sensor	\$70.75
L-LED-SMPPHOTO-1	27W SimpLED Inline Photo Sensor	\$45.40
L-LED-SMPTD4-1	27W SimpLED Inline Touch Dimmer	\$55.10
L-LED-SMPADP-5-1	5cm 12VDC SimpLED Adaptor	\$3.65
L-LED-SMPADP-15-1	15cm 12VDC SimpLED Adaptor	\$3.95
L-LED-SMPADP-25-1	25cm 12VDC SimpLED Adaptor	\$4.45
L-LED-SMPADP-60-1	60cm 12VDC SimpLED Adaptor	\$6.15
L-LED-SMPADP-120-1	120cm 12VDC SimpLED Adaptor	\$7.85
L-LED-SMPADP-180-1	180cm 12VDC SimpLED Adaptor	\$9.35

Max Load 27W

ILO™ SERIES LED STRIP LIGHTING