

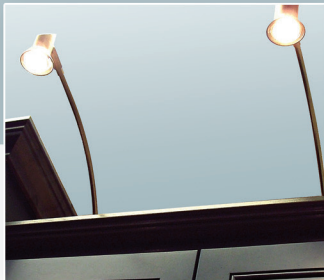

# Stellar<sup>®</sup>

make your displays  
come to life



*In addition to retail applications, the Stellar also provides dramatic overhead lighting for cabinet installations.*

**S**tellar, one of Tresco's most popular fixture series, represents the leading edge in commercial illumination.

The Stellar has always been an aesthetic masterpiece, blending elegant style with bold arcs to create a unique appearance. Now, thanks to LED technology, it offers unsurpassed performance and operating efficiencies.

The MR-16 LED replaces the standard halogen bulb, providing brilliant illumination while reducing energy consumption by 60%. And the 30,000-hour expected service life yields several years of maintenance-free operation.





The Stellar® Long Arc will provide a beautiful wash of light bringing out the craftsmanship and architectural details on cabinet doors. This easy to install lighting will fit into any kitchen or display with its attractive finishes and contemporary design. The Stellar® Long Arc is the perfect lighting for the project that needs to be seen.



Head swivels on ball joint.



- Long Arc with swivel head
- 12V DC MR-11 LED 1.5W bulb included.
- Four available finishes to complement any project.
- 2 meter (79") lead with available extensions.
- Easy installation
- 2 lengths - 14" and 25"

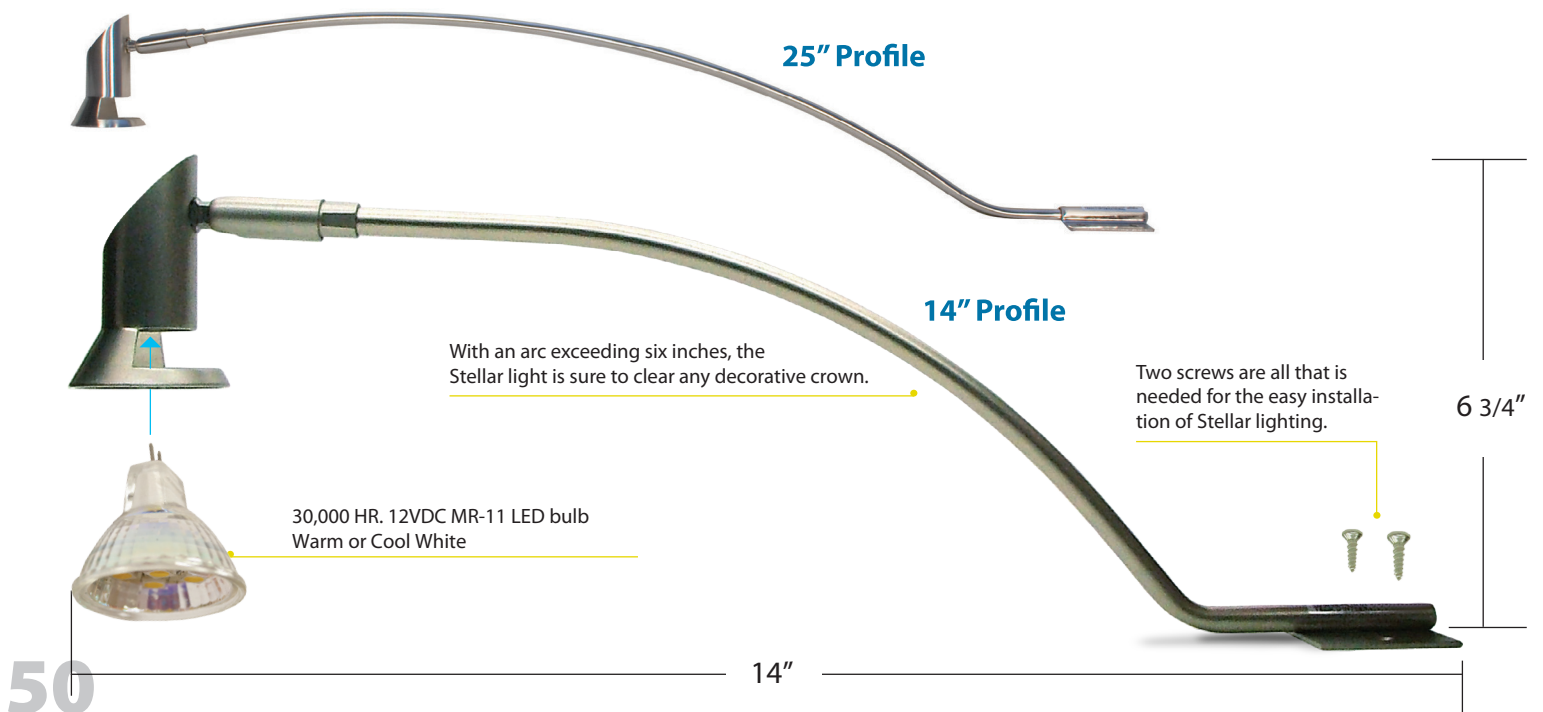

# Gridwall Stellar®

make your displays  
come to life



## ACCESSORIES

- A. DC 18W power supply (6 light max)
- B. DC 60W power supply (20 light max)



## MR-16 LED 3W

- Patented die-cast design  
*(for proper thermal management)*
- 30,000-hour life
- Chrome, white, black
- Use on 12V DC systems
- Consumes only 3 Watts
- 2700K or 4800K color temperatures

Available Colors: White, Black, Chrome

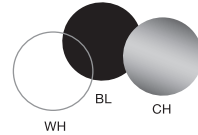

## MR-16 LED



## FEATURES

- Durable all-metal construction
- 30,000-hour life, replaceable MR-16 3W LED
- White/Black/Chrome finish (custom finish w/minimum order)
- 10' Lead
- Fits standard 3" O.C. grid panels
- Up to 20 lights per power supply\* (see Accessories)
- 2700K or 4800K color temperatures

## SPECS

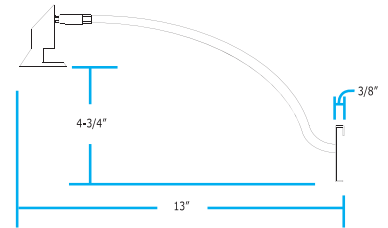
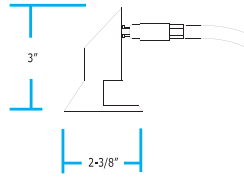
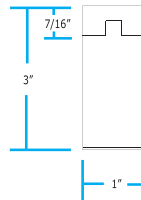

## ARC/ARM

- A. Flexible (gooseneck)
- B. Stationary



## CUSTOM OPTIONS\* (Minimum Required)

### MOUNTING BASES

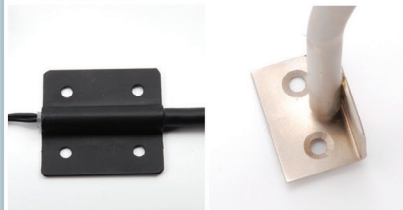

### LIGHT HEADS



### FINISHES

Custom color plating or powder coating available (almost any color/finish)



\*Not Limited. Custom Design Welcome.

**Required Items**

**Light Fixture**  
Flat Base (Top Mount)

Part #	Description	Suggested List
L-LEDSTL1-BL-SW-1	Black Top Mount Flat Base Light Fixture	\$92.35
L-LEDSTL1-CH-SW-1	Chrome Top Mount Flat Base Light Fixture	\$92.35
L-LEDSTL1-GD-SW-1	Gold Top Mount Flat Base Light Fixture	\$92.35
L-LEDSTL1-NI-SW-1	Nickel Top Mount Flat Base Light Fixture	\$92.35

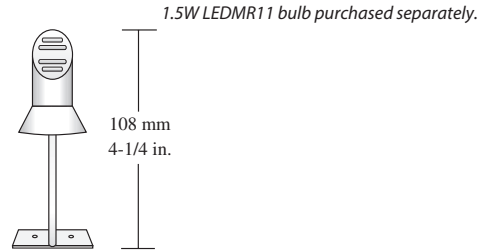
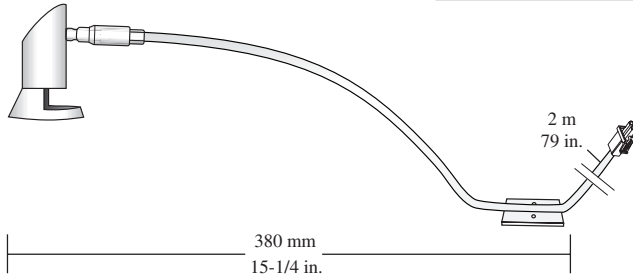

**Light Fixture**  
Flat Base (top mount)

Part #	Description	Suggested List
L-LEDSTL1-635-BL-SW-1	Black 635mm Top Mount Flat Base Light Fixture	\$106.30
L-LEDSTL1-635-CH-SW-1	Chrome 635mm Top Mount Flat Base Light Fixture	\$106.30
L-LEDSTL1-635-NI-SW-1	Nickel 635mm Top Mount Flat Base Light Fixture	\$106.30

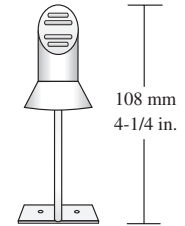
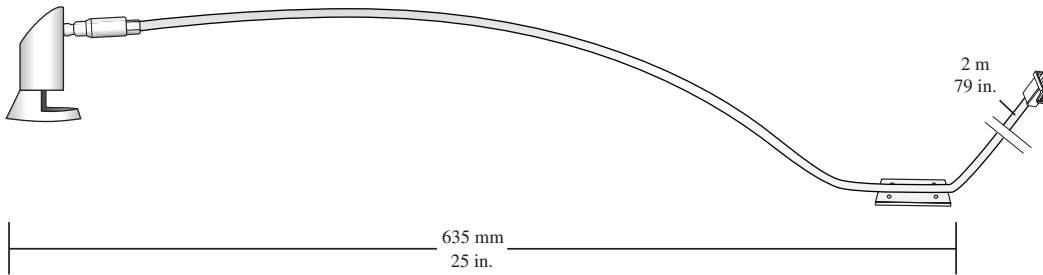

**Light Fixture (Gridwall Mount)**

Part #	Description	Suggested List
L-LEDSTL3-330WR-CBL-1	330mm (13") Stationary Gridwall Stellar, 4800K, Black	\$92.20
L-LEDSTL3-330WR-CCH-1	330mm (13") Stationary Gridwall Stellar, 4800K, Chrome	\$92.20
L-LEDSTL3-330WR-CWH-1	330mm (13") Stationary Gridwall Stellar, 4800K, White	\$92.20
L-LEDSTL3-330WR-WBL-1	330mm (13") Stationary Gridwall Stellar, 2700K, Black	\$92.20
L-LEDSTL3-330WR-WCH-1	330mm (13") Stationary Gridwall Stellar, 2700K, Chrome	\$92.20
L-LEDSTL3-330WR-WWH-1	330mm (13") Stationary Gridwall Stellar, 2700K, White	\$92.20
L-LEDSTL3-330WRG-CBL-1	330mm (13") Gooseneck Gridwall Stellar, 4800K, Black	\$92.20
L-LEDSTL3-330WRG-CCH-1	330mm (13") Gooseneck Gridwall Stellar, 4800K, Chrome	\$92.20
L-LEDSTL3-330WRG-CWH-1	330mm (13") Gooseneck Gridwall Stellar, 4800K, White	\$92.20
L-LEDSTL3-330WRG-WBL-1	330mm (13") Gooseneck Gridwall Stellar, 2700K, Black	\$92.20
L-LEDSTL3-330WRG-WCH-1	330mm (13") Gooseneck Gridwall Stellar, 2700K, Chrome	\$92.20
L-LEDSTL3-330WRG-WWH-1	330mm (13") Gooseneck Gridwall Stellar, 2700K, White	\$92.20

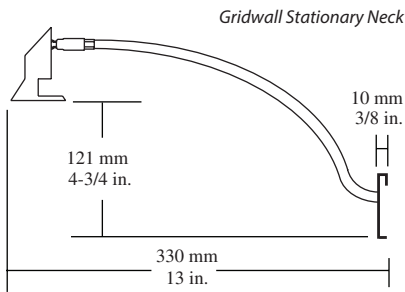

Gridwall Gooseneck

Cord 3 m (10') and MR-16 LED 3W bulb are included with each Light Fixture.

## Required Items

### DC Power Supply - 18W

Electronic.

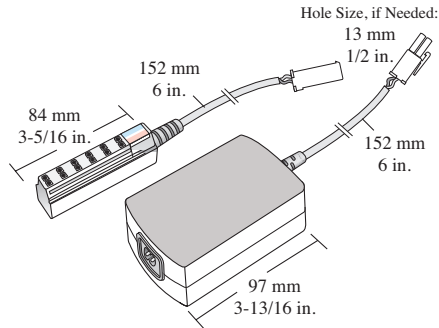

Part #	Description	Suggested List
L-DC-ELT18-CON-1	18W 12VDC Power Supply w/6 Snap Mounting Block	\$61.20

*Dimmable on trailing edge (12V side).  
Mounting Block and Power Cord are included with each Power Supply.*

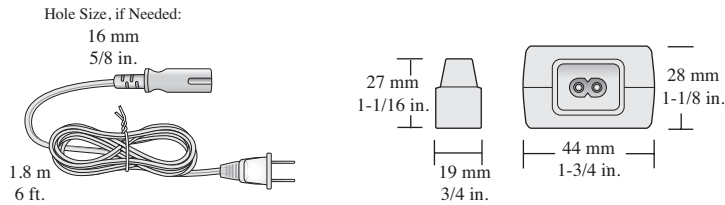

### DC Power Supply - 60W

Electronic.

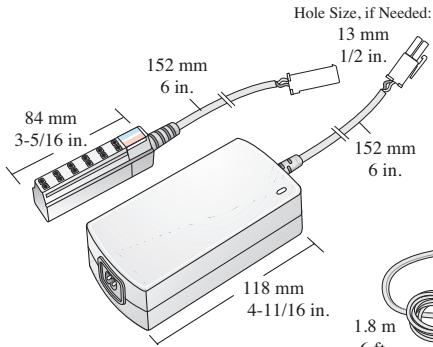

Part #	Description	Suggested List
L-DC-ELT60-CON-1	60W 12VDC Power Supply w/6 Snap Mounting Block	\$73.80

*Dimmable on trailing edge (12V side).  
Mounting Block and Power Cord are included with each Power Supply.*

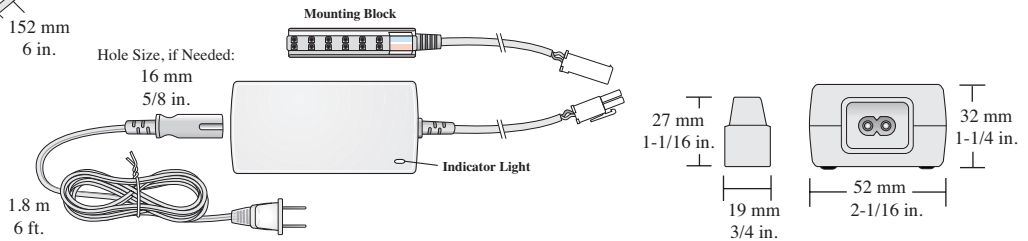

All product dimensions and specifications are subject to change without prior notice.

Optional Items

Touch On/Off Switch

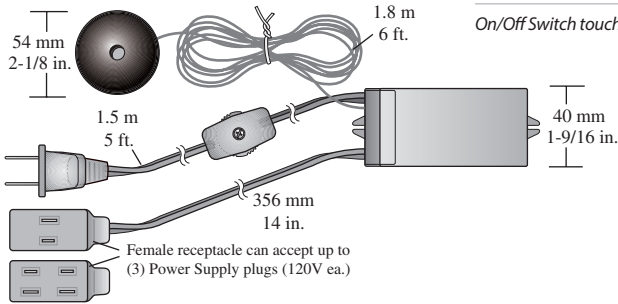

Part #	Description	Suggested List
L-TS2-72-1	Touch On/Off w/Cord And Touch Pad. Black.	\$48.45

On/Off Switch touch pad attaches to surface with adhesive backing. Power Supply plugs into On/Off Switch.

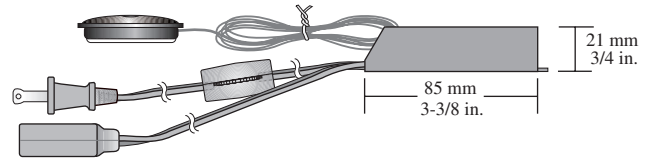

Round Switch - 12V

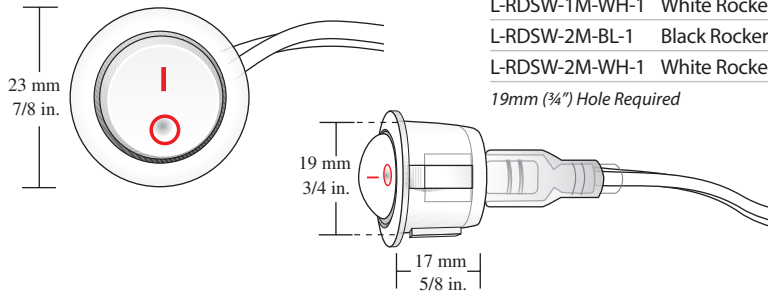

Part #	Description	Suggested List
L-RDSW-1M-BL-1	Black Rocker Switch w/1m (39") Lead, 12VAC/DC	\$16.40
L-RDSW-1M-WH-1	White Rocker Switch w/1m (39") Lead, 12VAC/DC	\$16.40
L-RDSW-2M-BL-1	Black Rocker Switch w/2m (79") Lead, 12VAC/DC	\$18.40
L-RDSW-2M-WH-1	White Rocker Switch w/2m (79") Lead, 12VAC/DC	\$18.40

19mm (3/4") Hole Required

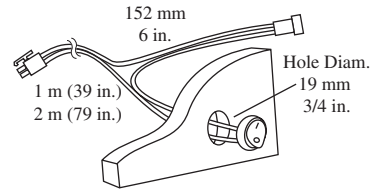

Roll Switch - 120V

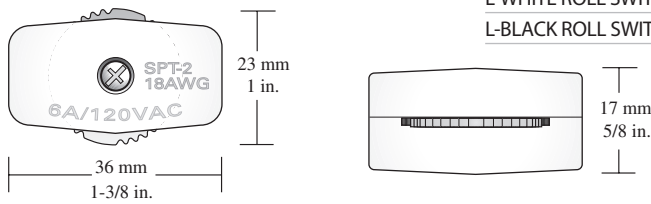

Part #	Description	Suggested List
L-WHITE ROLL SWITCH-1	120V White Roll Switch	\$2.45
L-BLACK ROLL SWITCH-1	120V Black Roll Switch	\$2.45

AMP® Connector

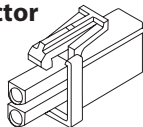

Part #	Description	Suggested List
L-MALE AMP	AMP® Connector for Light Fixture	\$10.15

AMP® Connector is included with each Light Fixture.

All product dimensions and specifications are subject to change without prior notice.

## Optional Items

### Extension Cord

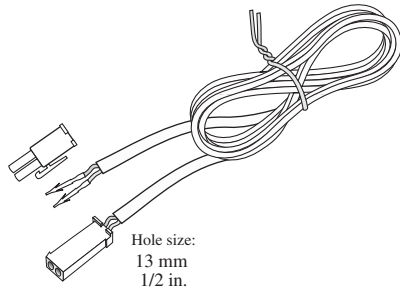

Part #	Description	Suggested List
L-LED-LINKD-15-1	15cm (6") 12VDC Starter/Link/Extension Cord	\$4.05
L-LED-LINKD-25-1	25cm (10") 12VDC Starter/Link/Extension Cord	\$5.95
L-LED-LINKD-60-1	60cm (24") 12VDC Starter/Link/Extension Cord	\$6.65
L-LED-LINKD-120-1	120cm (48") 12VDC Starter/Link/Extension Cord	\$8.25
L-LED-LINKD-180-1	180cm (72") 12VDC Starter/Link/Extension Cord	\$10.00

13 mm (1/2 in.) Hole Required

### Replacement Bulb - MR-11 LED - 1W

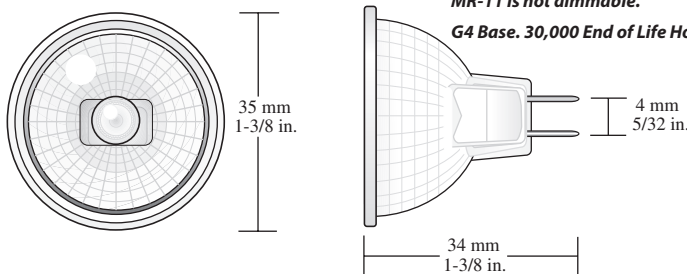

Part #	Description	Suggested List
L-LB-LEDMR11-1W-W-1	1W 2700K MR11, 12VDC	\$42.80
L-LB-LEDMR11-1W-C-1	1W 4800K MR11, 12VDC,	\$42.80

**MR-11 is not dimmable.**  
**G4 Base. 30,000 End of Life Hours**

### Replacement Bulb, MR-16 LED - 3W

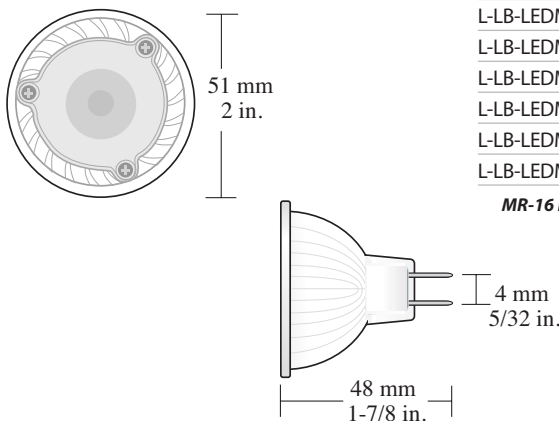

Part #	Description	Suggested List
L-LB-LEDMR16-3W-CBL-1	3W 4800K MR16, 12VDC, Black	\$51.90
L-LB-LEDMR16-3W-CCH-1	3W 4800K MR16, 12VDC, Chrome	\$51.90
L-LB-LEDMR16-3W-CNI-1	3W 4800K MR16, 12VDC, Nickel	\$51.90
L-LB-LEDMR16-3W-CWH-1	3W 4800K MR16, 12VDC, White	\$51.90
L-LB-LEDMR16-3W-WBL-1	3W 2700K MR16, 12VDC, Black	\$51.90
L-LB-LEDMR16-3W-WCH-1	3W 2700K MR16, 12VDC, Chrome	\$51.90
L-LB-LEDMR16-3W-WNI-1	3W 2700K MR16, 12VDC, Nickel	\$51.90
L-LB-LEDMR16-3W-WWH-1	3W 2700K MR16, 12VDC, White	\$51.90

**MR-16 is not dimmable. 30,000 End of Life Hours**

All product dimensions and specifications are subject to change without prior notice.