

(Not to scale)

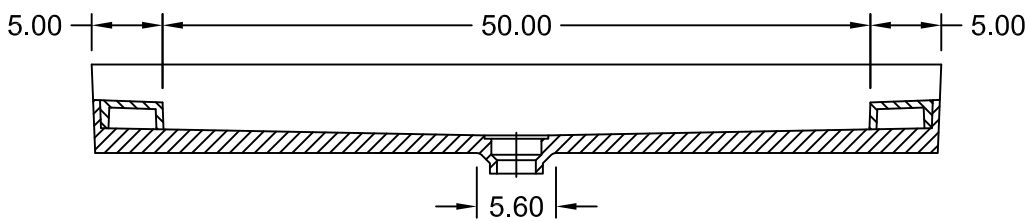

SECTION A-A

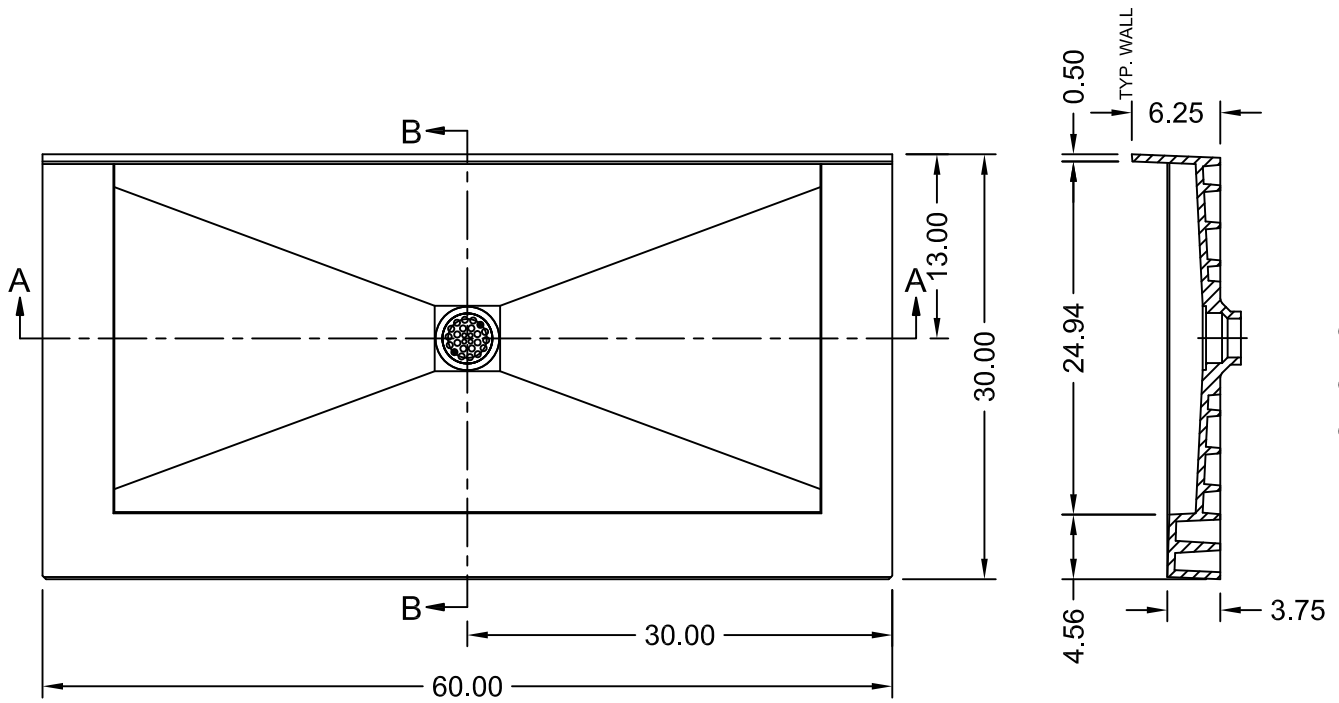

ANSI Z124.1-95    ASTM F462-79  
ANSI Z124.2-95    B45.0-02  
ICC/ANSI A117.1.98    B45.5-02

Toll Free 800.232.6156    techsupport@tileredi.com  
Tel: 954.323.0125  
Fax: 954.344.8064    www.tileredi.com



V.8.20.12