

INSTALLATION INSTRUCTIONS

Model# 73285-66

READ AND SAVE THESE INSTRUCTIONS

WARNING! SHUT POWER OFF AT FUSE OR CIRCUIT BREAKER.

AVERTISSEMENT! COUPER LE COURANT AU NIVEAU DES FUSIBLES OU DU DISJONCTEUR.

PREPARING FOR INSTALLATION (Fig. 1)

1. Shut off power at the fuse box or circuit breaker box and remove the old fixture including the mounting hardware.
2. Carefully unpack your new fixture and lay out all the parts in a clear area. Take care not to misplace any small parts necessary for installation.
3. Pull black, white and ground wires out of base cup (D).

CONNECTING THE WIRES (Fig. 2)

4. Connect electrical wires as shown in Fig. 2 with wire connectors (B). If your post (A) (not included) has a ground wire (green or bare copper), connect fixture ground wire to it. If not, consult your electrician for proper grounding.
5. Tuck wire connectors carefully inside base cup (D).
6. Align base cup (D) with post (A) and secure with mounting screws (C). (Fig.1)
7. Loosen screw (F, 2pcs) and separate top cover (E) from upper frame (H).
8. Install (4) four candelabra base bulbs (K) up to 40 Watts, or CFL or LED equivalent (not included), in accordance with the fixture specification. **(DO NOT EXCEED THE MAXIMUM WATTAGE RATING) (NE PAS DEPASSER LA PUISSANCE NOMINALE MAXIMALE!)**
9. Secure cover (E) to upper frame (H) with screws (F) until tight.
10. To replace glass, loosen screw (F) and separate top cover (E) from upper frame (H). Then loosen screw (G) to separate upper frame (H) from fixture frame (J). Insert new glass (I) into fixture frame from above. Secure upper frame (H) to fixture frame (J) with screws (G, 4pcs) until tight. Then reinstall top cover (E) on upper frame (H) with screws (F).
11. This fixture is ETL listed for wet location applications.

Your installation is now complete. Return power to the outlet box and test the fixture.



“CAUTION-RISK OF FIRE CONSULT A QUALIFIED ELECTRICIAN TO ENSURE CORRECT BRANCH CIRCUIT CONDUCTOR”

ATTENTION – RISQUE D’INCENDIE, CONSULTER UN ÉLECTRICIEN QUALIFIÉ POUR VOUS ASSURER QUE LES CONDUCTEURS DE LA DÉRIVATION SONT ADÉQUATS.

Fig. 1

Candle Cover (4) (Part# CCV21069P-66)

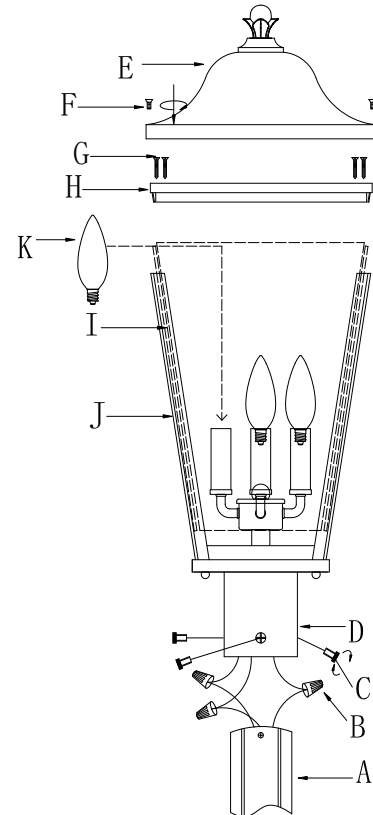

Glass code# G73282

Fig.2

