









Location:

Origins™

S-9604-PLR Tub/Hand Shower System Specification Submittal



Model Numbers	Specification
<input type="checkbox"/> S-9604-PLR <i>Origins Tub/Hand Shower System</i>	<p>Tub/hand shower system powered by the Temptrol® Pressure Balancing valve. Features integrated diverter, 36" slide bar, non-diverter tub spout, in-line vacuum breaker, 60" flexible metal hose, ADA hand shower and standard 2.5 gpm (9.5 L/min) flow restrictor. Components made from metal and nonmetallic materials plated in standard polished chrome finish.</p> <div style="text-align: right;">   </div>
<p>Modifications</p> <ul style="list-style-type: none"> <input type="checkbox"/> -1.5  1.5 gpm (5.7 L/min) flow restrictor <input type="checkbox"/> -2.0  2.0 gpm (7.6 L/min) flow restrictor <input type="checkbox"/> -SS Slip spout on any tub/shower unit <input type="checkbox"/> -X Integral service stops <input type="checkbox"/> -CHKS Integral check stops <input type="checkbox"/> -IPS 1/2" female IPS connections <input type="checkbox"/> -REV Reverse coring for back to back installations <input type="checkbox"/> -LP Loop handle <input type="checkbox"/> -B Chrome brass escutcheon <input type="checkbox"/> -D Chrome brass dome cover <input type="checkbox"/> -VP Vandal proof escutcheon screws <input type="checkbox"/> -QD Quick disconnect on hand shower units <input type="checkbox"/> -R White vinyl hose in place of metal hose <input type="checkbox"/> -VB Elevated vacuum breaker <input type="checkbox"/> -OP 13" oval plate <input type="checkbox"/> -72 6' hose in place of 5' standard <input type="checkbox"/> -TRM Trim only, valve not included <input type="checkbox"/> -STN Satin Nickel finish <p>Note: Append appropriate -suffix to model number.</p>	<p>Compliance</p> <ul style="list-style-type: none"> -ASME A112.18.1/CSA B125.1 -WaterSense 1.5 gpm (5.7 L/min) 2.0 gpm (7.6 L/min) <p>(Compliance pending)</p> <div style="text-align: right;">   </div> <p>Warranty</p> <p>Limited Lifetime - to the original end purchaser in consumer/residential installations. 5 Years - for industrial/commercial installations. Refer to www.symmons.com/warranty for complete warranty information.</p>

Dimensions

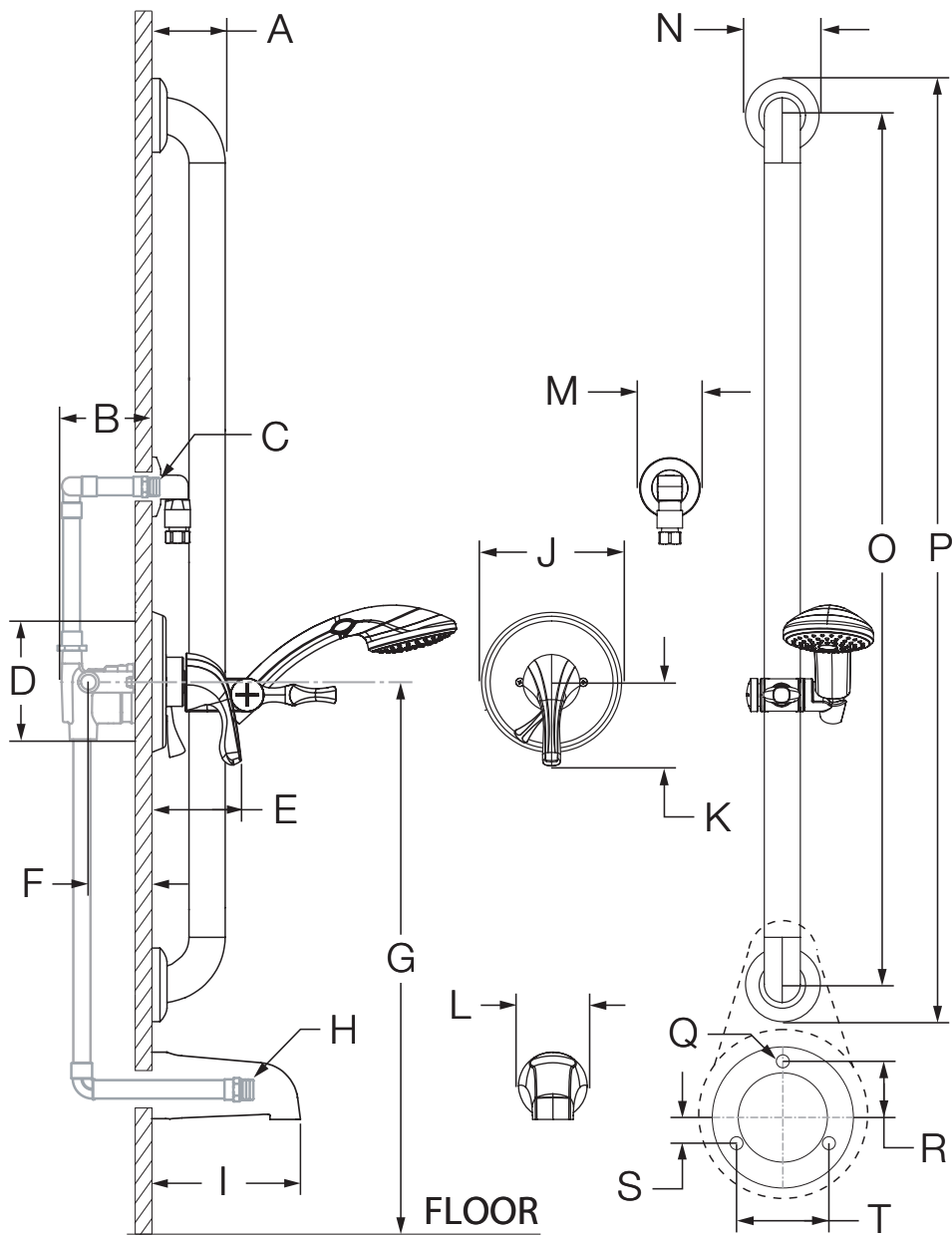

Measurements	
A	3", 76 mm
B	3 1/2", 89 mm
C	Male 1/2" NPT fitting must protrude 3/8" from finished wall
D	Shower Valve Hole Size Min. Ø 3", 76 mm Max. Ø 4", 102 mm
E	3 5/8", 92 mm
F	Rough-in 2 3/8" ± 1/2", 60 mm ± 13 mm
G	Ref. 32", 813 mm
H	Male 1/2" NPT fitting must protrude 4" from finished wall
I	5 1/2", 140 mm
J	Ø 5 3/4", 146 mm
K	3 3/8", 86 mm
L	Ø 2 1/2", 64 mm
M	Ø 2 1/2", 64 mm
N	Ø 3 1/8", 79 mm
O	36", 914 mm
P	39", 991 mm
Q	(6x) Hole Size Ø 5/16", 8 mm
R	1", 25 mm
S	1/2", 13 mm
T	1", 25 mm

Notes:

- 1) All dimensions measured from nominal rough-in (see F as reference).
- 2) Dimensions subject to change without notice.

Emplacement:



SYMMONS[®] Origins[™]







the smart choice[™]

S-9604-PLR

Système de baignoire avec douche à main

Présentation des spécifications



Numéro de modèle	Spécification
<input type="checkbox"/> S-9604-PLR <i>Système de baignoire avec douche à main Origins</i>	<p>Le système de baignoire avec douche à main comprend la vanne à pression autorégularisée Temptrol[®]. Figurer inverseur intégré, une barre de glissement de 36 po, un bec de baignoire non-déviateur, un reniflard de ligne, 60 po tuyau flexible en métal et 1 douche à main avec un réducteur de débit régulier de 2,5 gpm (9,5 L/min). Les composants sont faits de matériaux métalliques et non métalliques au fini chrome poli standard.</p> <div style="text-align: right;">   </div>
Modifications	Conforme
<ul style="list-style-type: none"> <input type="checkbox"/> -1.5  Régulateur de débit de 1,5 gpm (5,7 L/min) <input type="checkbox"/> -2.0  Régulateur de débit de 2,0 gpm (7,6 L/min) <input type="checkbox"/> -SS <i>Bec de baignoire à enfiler unité baignoire-douche</i> <input type="checkbox"/> -X <i>Robinet d'interruption du service</i> <input type="checkbox"/> -CHKS <i>Valve d'arrêt intégrée</i> <input type="checkbox"/> -IPS <i>Raccords IPS femelles de 1/2 po</i> <input type="checkbox"/> -REV <i>Corps central inversé our installations dos à dos</i> <input type="checkbox"/> -LP <i>Poignée en boucle</i> <input type="checkbox"/> -B <i>Vanne de la rosace chrome laiton</i> <input type="checkbox"/> -D <i>Couvercle en dôme chrome laiton</i> <input type="checkbox"/> -VP <i>Vis de rosace résistant au vandalisme</i> <input type="checkbox"/> -QD <i>Débranchement rapide pour de douche à main</i> <input type="checkbox"/> -R <i>Tuyau de vinyle blanc</i> <input type="checkbox"/> -VB <i>Reniflard surélevé</i> <input type="checkbox"/> -OP <i>Assiette ovale 13 po</i> <input type="checkbox"/> -72 <i>Tuyau de 6' au lieu de 5' standard</i> <input type="checkbox"/> -TRM <i>Garniture seulement, vanne non incluse</i> <input type="checkbox"/> -STN <i>Fini nickel satiné</i> 	<ul style="list-style-type: none"> -ASME A112.18.1/CSA B125.1 -WaterSense 1.5 gpm (5.7 L/min) 2.0 gpm (7.6 L/min) <p>(Conformité en attendant)</p> <div style="text-align: right;">   </div>
<p>Remarque: Juxtaposer le -suffixe approprié au numéro de modèle.</p>	Garantie <p>À vie limitée - à l'acheteur original dans les installations du consommateur ou résidentielles. 5 ans - pour des installations commerciales et industrielles. Se reporter au site www.symmons.com/warranty (en anglais) pour l'information complète concernant la garantie.</p>

Dimensions

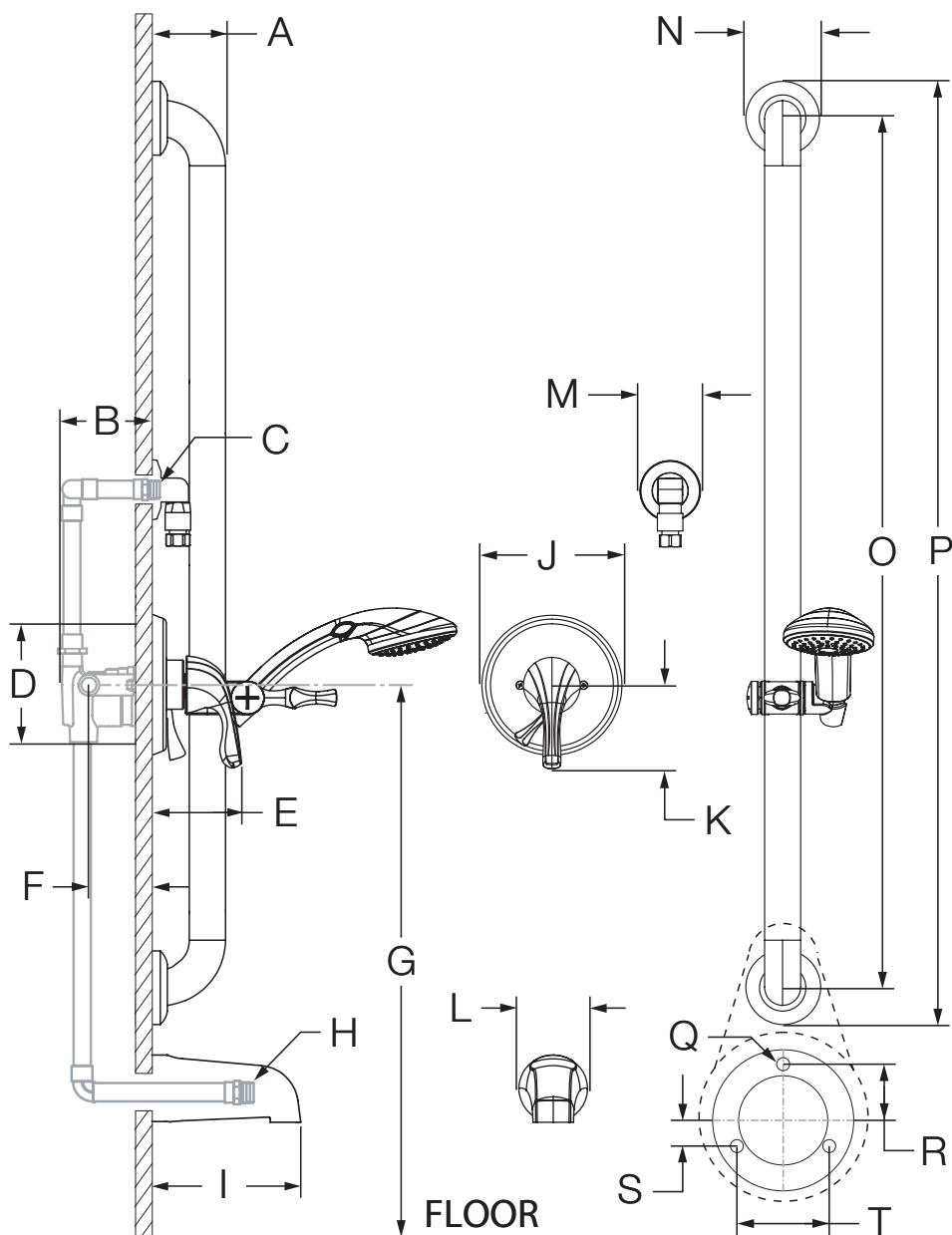

Mesures	
A	3 po, 76 mm
B	3 1/2 po, 89 mm
C	1/2 po mâle à filets NPT doit faire saillie de 3/8 po du mur fini
D	Taille du trou Min. Ø 3 po, 76 mm Max. Ø 4 po, 102 mm
E	3 5/8 po, 92 mm
F	Robinetterie brute 2 3/8 po ± 1/2 po, 60 mm ± 13 mm
G	Réf. 32 po, 813 mm
H	1/2 po mâle à filets NPT doit faire saillie de 4 po du mur fini
I	5 1/2 po, 140 mm
J	Ø 5 3/4 po, 146 mm
K	3 3/8 po, 86 mm
L	Ø 2 1/2 po, 64 mm
M	Ø 2 1/2 po, 64 mm
N	Ø 3 1/8 po, 79 mm
O	36 po, 914 mm
P	39 po, 991 mm
Q	(6x) Taille du trou Ø 5/16 po, 8 mm
R	1 po, 25 mm
S	1/2 po, 13 mm
T	1 po, 25 mm

Remarques:

- 1) Toutes les dimensions sont mesurées à partir de la robinetterie brute nominale (voir F en référence).
- 2) Les dimensions sont sujettes à changer sans préavis.