

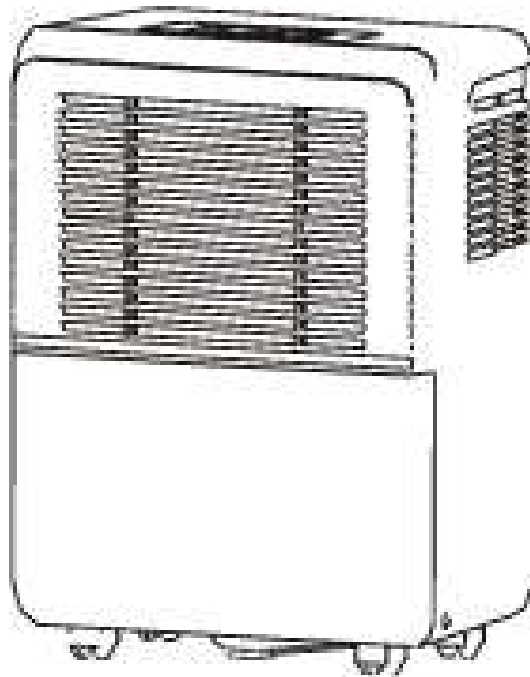

DEHUMIDIFIER

MODELS: SD-31E / SD-41E / SD-61E /
SD-71E



INSTRUCTION MANUAL

Please read these instructions thoroughly and
keep it in a safe place for future reference.

CONTENTS

SAFETY PRECAUTIONS.....	2
ELECTRICAL INFORMATION	2
CONTROL PANEL	4
FEATURES.....	5
IDENTIFICATION OF PARTS	6
OPERATING THE UNIT.....	6
IDENTIFICATION OF PARTS	6
CONTINUOUS DRAINAGE	7
CARE AND MAINTENANCE	8
TECHNICAL SPECIFICATIONS	9
TROUBLE SHOOTING.....	9

SOCIABLE REMARK

DISPOSAL: Do not dispose this product as unsorted municipal waste. Collection of such waste separately for special treatment is necessary.

It is prohibited to dispose of this appliance in domestic household waste.

For disposal, there are several possibilities:

- A) The municipality has established collection systems, where electronic waste can be disposed of at free of charge to the user.
- B) The manufacturer will take back the old appliance for disposal at free of charge to the user.
- C) As old products contain valuable resources, they may be sold to scrap metal dealers.

Wild disposal of waste in forest and landscapes endangers your health when hazardous substances leak into the ground-water and find their way into the food chain.





BEFORE YOU USE YOUR **DEHUMIDIFIER**, PLEASE READ THIS INSTRUCTION MANUAL CAREFULLY.

SAFETY PRECAUTIONS

To prevent injury and property damage, the following instructions must be followed. Incorrect operation due to ignoring of instructions may cause harm or damages.

The seriousness is classified by the following indications:

 **WARNING:** This symbol indicates the possibility of death or serious injury.

 **CAUTION:** This symbol indicates the possibility of injury or damage to property.

-----  **WARNING** -----

1. Do not exceed the rating of the power outlet or connection device.
2. Do not operate or stop the unit by means of the power plug.
3. Do not use unit with damaged cord or connect unit to damaged electrical socket.
4. Do not modify power cord length or share outlets with other appliances.
5. Do not insert or remove plug with wet hands.
6. Do not use in the following locations:
 - Next to or near a heat source (radiator, heater, dryer, etc.)
 - Area where oil or water is likely to splash.
 - Under direct sunlight.
 - Near a bath, shower or swimming pool.
 - In a greenhouse.
 - Near flammable gas or combustibles, such as gasoline, benzene, thinner, etc.
 - Where chemicals are handled.
7. Disconnect power if strange sound, smell or smoke emits from the unit.
8. Never try to take apart or repair the unit by yourself. There are no user serviceable parts.
9. Always power off and unplug the unit before cleaning and maintenance.
10. Do not drink or use the water drained from the unit
11. Do not remove water bucket during operation.



CAUTION

1. Do not use the unit in small spaces for lack of air ventilation.
2. Place the unit on a level, sturdy ground.
3. Do not cover the units and its air inlets/outlets.
4. Care should be taken when using the unit in a room with the following: infants, children, elderly people, and people not sensitive to humidity.
5. Never insert your finger or other foreign objects into grills or openings. Take special care to warn children of these dangers.
6. Do not place heavy objects on the power cord and be sure cord is not compressed.
7. Do not climb on or sit on the unit.
8. Always operate with filters properly installed. Notes: Clean filter once every two weeks.
9. If water enters the unit, turn unit off immediately and contact Sunpentown.
10. Do not place flower vases or other water container on top of the unit.

Electrical Information

- The manufacture's rating label is located on the back panel of the unit and contains electrical and other technical data specific to this unit.
- Be sure the unit is properly grounded. To minimize shock and fire hazards, proper grounding is important. The power cord is equipped with a three-prong grounding plug for protection against shock. Never remove the grounding prong.
- Your unit must be used in a properly grounded wall receptacle. If the wall receptacle you intend to use is not adequately grounded or protected by a time delay fuse or circuit breaker, have a qualified electrician install the proper receptacle.
- Ensure the receptacle is accessible after the unit installation.
- **Do not use extension cords or an adapter plugs with this unit.** However, if it is necessary to use an extension cord, use an approved Dehumidifier extension cord only (available at most local hardware stores).
- To avoid the possibility of personal injury, always disconnect the power supply to the unit, before installing and/or servicing.

CONTROL PANEL

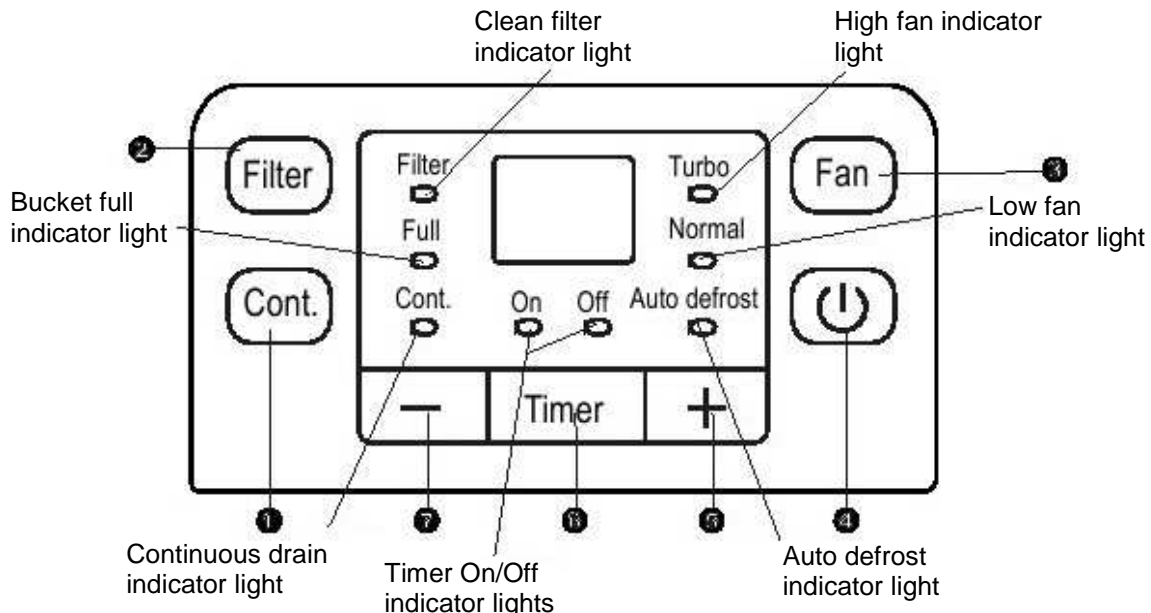

Control Buttons: whenever a button is pressed, the unit will make a beep sound to indicate that it is changing modes.

- ❶ **CONT:** Press to activate continuous dehumidifying mode.
- ❷ **FILTER:** The check filter feature is a reminder to clean the air filter for more efficient operation. The Filter Indicator Light will illuminate after 250 hours of operation. To reset after cleaning the filter, press the Filter button to turn off indicator light.
- ❸ **FAN:** Controls the fan speed. Press to select Turbo (high) or Normal fan speed. Set the fan to Turbo for maximum moisture removal. When the humidity has reduced or when quiet operation is preferred, set the fan speed to Normal.
- ❹ **POWER:** Press to turn the dehumidifier on and off.
- ❺/❻ **UP(+)/DOWN(-):**
 - Set humidity level: Press to increase or decrease set humidity level. Range of adjustment is from 35% to 85% RH, in 5% increments.
 - Set timer: Press to set timer, from 0 to 24 hours.
- ❼ **TIMER:** Press to initiate auto-start and auto-stop feature, works with + and - buttons.

DISPLAY PANEL

- Displays the set humidity level (from 35% to 85%) or auto-start/stop time (0-24) while setting, then returns to display actual room humidity level ($\pm 5\%$ accuracy), in a range of 30% RH to 90%RH (relative humidity).
- Displays error codes and protection codes:
 - **AS** – Humidity sensor error. Unplug and plug back in. If error repeats, call for service.
 - **ES** – Temperature sensor error. Unplug and plug back in. If error repeats, call for service.
 - **P2** – Bucket is full or bucket not properly seated. Empty bucket and replace in correct position.
 - **EC** – Unit malfunction. Please make sure the environment temperature is suitable for operation.

Other Features

- **Bucket Full Light:** Illuminates when the bucket is full and needs to be emptied; or when bucket is removed or not properly seated.
- **Auto Shut Off:** The unit shuts off after 30 seconds when bucket becomes full or when bucket is removed / not properly seated; or when set humidity is reached (the fan motor will continue to run for additional 3 minutes then stop).
- **Auto Defrost:** When frost builds up on the evaporator coils, the compressor will cycle off and the fan will continue to run until the frost disappears.
- **3 Minute Delay:** After the unit has stopped (or powered off), there will be a 3-minute delay before it will resume operation again. This is to protect the compressor. Operation will automatically start after 3 minutes.
- **Check Filter Feature:** The system begins calculating the time once fan motor begins operation. The check filter feature will be activated when operation time achieves 250 hours or more - the clean filter indicator light will begin to flash. After filter has been cleaned and replaced, press the Filter button to reset and the clean filter indicator will go off.
- **Auto-Restart:** If the unit breaks off unexpectedly due to power cut, unit will resume at previous setting when power returns.
- **Timer On and Timer Off:** Unit can be set to auto-start/stop, up to 24 hours:
 - When unit is on: press of the Timer button and the Timer-Off indicator will illuminate (indicating auto-stop is initiated). Press Timer button again and the Timer-On indicator will illuminate (indicating auto-start is initiated).
 - When the unit is off: press of the Timer button and the Timer-On indicator will illuminate (indicating auto-start is initiated). Press Timer button again and the Timer-Off indicator will illuminate (indicating auto-stop is initiated).
 - Press or hold the +/- buttons to change the set time in 0.5-hour increments, up to 10 hours; then in 1-hour increments, up to 24 hours.
 - The selected time will register after 5 seconds and the panel will revert back to displaying ambient humidity.
 - When both auto-start and auto-stop times are set, both Timer On and Off indicator lights are illuminated, identifying both On and Off timers are now programmed.
 - Turning the unit on or off at any time or adjusting the timer setting to 0.0 will cancel any timer programs.
 - Timer program is also cancelled when LED displays P2 error code.
 - The control will count down the remaining time.

IDENTIFICATION OF PARTS

FRONT

1. Control panel
2. Air intake grille
3. Air outlet grille
4. Air filter (behind the grille)
5. Water bucket
6. Handle (both sides)

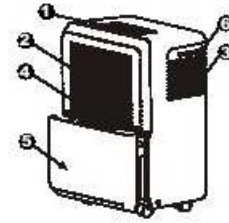

REAR

1. Drain hose outlet
2. Caster
3. Power cord and plug
4. Band (for use when storing the unit)

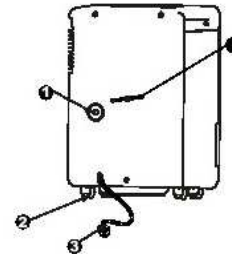

ACCESSORIES

Drain hose(1pc)

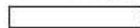

adaptorA(1pc)

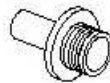

screw(2pc)



Note: all pictures in this manual are for explanation purposes only. The actual product may differ slightly, but the operations and functions are the same.

OPERATING THE UNIT

Positioning the unit

A dehumidifier will have little or no effect in drying an adjacent enclosed area, such as a closet, unless there is adequate circulation of air in and out of the area.

- Do not use outdoors.
- This dehumidifier is intended for indoor residential applications only. This dehumidifier should not be used for commercial or industrial applications.
- Place the dehumidifier on a smooth, level floor strong enough to support the unit with a full bucket of water.
- Allow at least 8 inches of space around the unit and 16 inches above the unit.
- Place the unit in an area where temperature will not fall below 5°C/41°F or the coils may become covered with frost, which may reduce performance.
- Place the unit away from the clothes dryer, heater or radiator.
- Use the unit to prevent moisture damage where books or valuables are stored.
- Use the unit in a basement to help prevent moisture damage.
- The dehumidifier must operate in an enclosed area to be most effective.
- Close all doors, windows and other outside openings to the room.

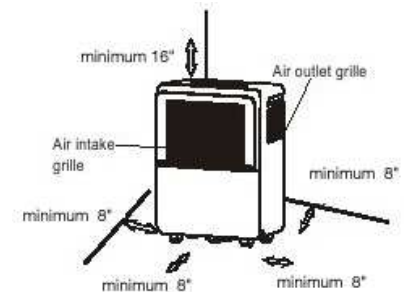

Casters

- Allow unit to move freely
- Do not force casters to move over carpet
- Do not move unit with water in the bucket as unit may tip over and spill water

Before using the unit

- When running the unit for the first time, operate the unit continuously for 24 hours.
- This unit is designed to operate within ambient temperature of 5°C/41°F to 35°C/95°F.
- If the unit has been switched off and needs to be switched on again, please allow 3 minutes protection time delay.
- Do not connect the dehumidifier to a multiple socket that is shared with other appliances.
- Select a suitable location, making sure you have easy access to an electrical outlet.
- Plug the unit into an electrical outlet with ground connection.
- Make sure water bucket is properly seated or the unit will not operate.

Removing collected water

- When the bucket becomes full, compressor will shut off (fan continues to run for 30 seconds to dry off water on the condenser) and unit will beep 8 times. The Full indicator light will flash and digital panel will display P2.
- Hold the left and right handles securely and slowly pull bucket straight outwards. Do not put down the bucket, its bottom is uneven and will tip over, causing water to spill.
- Dump out water and replace the bucket. The bucket must be replaced properly for the unit to operate.
- The dehumidifier will re-start when the bucket is restored in its correct position.

NOTES:

- When you remove the bucket, do not touch any parts inside the unit. Doing so may damage the product.
- Gently push the bucket all the way in.
- When the bucket is removed and you notice water in the unit, you must dry up the water.

Continuous Drainage

- Water can be automatically emptied into a floor drain by attaching the unit with a water hose (ID≥Ø5/16") with a female threaded end (ID:M=1"). Note: water hose is not included:

- Connect the drain hose to Adapter A
- Remove the plastic cover for the drain outlet, located on the back of unit. Remove bucket and insert the drain hose through the outlet and securely press it into the connector on.
- Tighten the connection between Adapter A and the unit by using the two provided screws.
- Install the female threaded end of the water hose to Adapter A. Then lead the water hose to the floor drain or suitable drainage facility

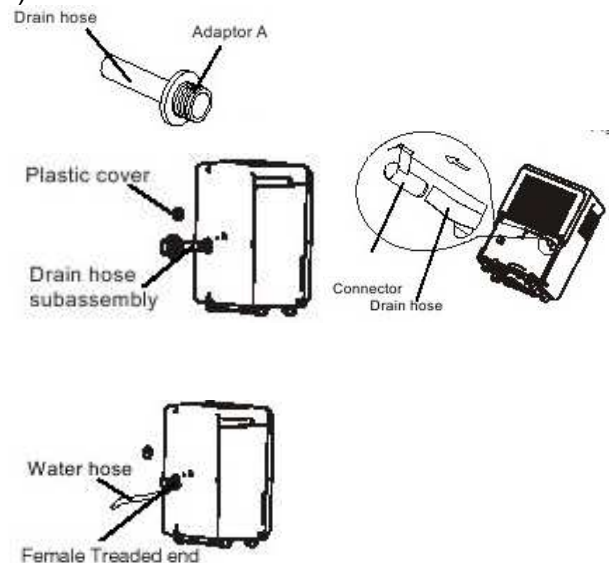

- Make sure the connections are secure so there will be no leaks.
- Direct the hose toward the drain, be sure there are no kinks that will stop the water flow.
- Continuous drain is gravity-pulled, be sure the hose is level or going downwards to allow water to flow smoothly.
- Place the bucket back in place and make sure it is seated properly.
- When continuous drain is not being used, remove the drain hose assembly.

CARE AND MAINTENANCE

Always turn the dehumidifier off and unplug from power source before cleaning.

Clean the Grille and Housing

- Use water and a mild detergent. Do not use bleach or abrasives
- Do not splash water directly onto the unit. Doing so may cause electric shock, cause the insulation to deteriorate or cause the unit to rust.
- The air intake and outlet grilles get dirty easily, use a vacuum attachment or brush to clean.

Clean the Water Bucket

- Every few weeks, clean the bucket to prevent mold growth, mildew and bacteria.
- Partially fill the bucket with clean water and add a little mild detergent. Swish it around, empty and rinse.

Note: Do not place bucket in the dishwasher. After cleaning, make sure outside of bucket is dried off before replacing to its seat.

Clean the Air Filter

- Remove the filter from top of unit; or first remove bucket then pull filter downward to remove.
- Wash the filter with clean water and allow to air dry completely.
- Re-install the filter and replace bucket.

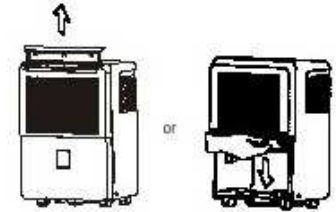

Caution: DO NOT operate the dehumidifier without a filter as dirt and lint will clog the compressor and reduce performance.

Storage

- After powering off and unplugging the unit, wait one day before emptying the bucket.
- Clean the unit, water bucket and air filter thoroughly.
- Allow to dry completely and replace filter and bucket.
- Wrap the cord and bundle with the band.
- Cover the unit with a plastic bag.
- Store the unit upright in a dry, well-ventilated place.

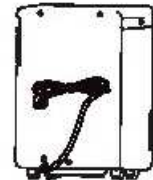

TECHNICAL SPECIFICATIONS

MODEL	SD-31E	SD-41E	SD-61E	SD-71E
Moisture Removal **	30 pints per day	40 pints per day	60 pints per day	70 pints per day
Power Supply	115V / 60Hz			
Current	3.0A	4.5A	4.9A	6.9A
Power Consumption	310W	450W	550W	720W
Energy Factor (EEV)	1.85 L/kWh			
Starting Current	14A	21A	28A	33A
Working Environment	41 ~ 95°F			
	35% to 85% RH			
Water Tank Capacity	3L		6L	
Air Flow (High/Low)	245/210 m3/h		320/280 m3/h	
Noise Level (High)	56 dB(A)		58.5 dB(A)	
Dimension	14.17(W) x 10.24(D) x 19.88(H) in.		15.35(W) x 10.98(D) x 23.15(H) in.	
Net/Gross Weight	29/31 lbs	30/32 lbs	40/42 lbs	

** Capacity will vary according to actual room ambient temperature and humidity conditions.

TROUBLE SHOOTING

BEFORE CONTACTING THE MANUFACTURER, PLEASE CHECK THE FOLLOWING POSSIBILITIES.

PROBLEM	CHECK
Unit fails to start	<ul style="list-style-type: none"> • Power is OFF or power cord is unplugged/not securely fitted. • Water bucket is not placed properly • Water bucket is full or set humidity has been reached • Check power to the outlet, fuse/circuit breaker box
Performance decreased	<ul style="list-style-type: none"> • Blocked air filter • Room windows and doors are open • Obstacles in air outlet or inlet • Not enough time allowed to remove the moisture • Humidity setting may be set too high • Ambient temperature is too cold, below 41°F
Unit is noisy	<ul style="list-style-type: none"> • Unstable setting of unit or floor surface is not level • Blocked filter
Frost appears on coils	<ul style="list-style-type: none"> • This is normal. The dehumidifier has Auto-Defrost feature
Water on floor	<ul style="list-style-type: none"> • Hose connection for continuous drainage is loose • Intend to use the bucket for water collection, but the drain plug is removed.
ES, AS P2 and EC appears in display	<ul style="list-style-type: none"> • Refer to error codes on page 4.
Unit is not collecting as much water during the winter months	<ul style="list-style-type: none"> • When temperature is low, absolute humidity level will drop as well, even when relative humidity is at the same percentage. There is less water vapor in the air when temperature is low
Difficulty inserting the continuous drain tube	<ul style="list-style-type: none"> • Soak the plastic white connector in hot water for a few minutes will soften the plastic and make it easier to connect.

If you still cannot solve the problem after trying the above, unplug unit and contact Sunpentown Int'l Inc.



Your Guarantee

If this product is found to be faulty as a result of faulty materials or workmanship within one year from date of purchase, it will be repaired free of charge.

This guarantee is subject to the following terms:

- Sunpentown must be notified of the fault.
- Proof of purchase must be presented to Sunpentown's nominated representative.
- The warranty will be void if the product is modified, misused or repaired by an unauthorized person.
- The warranty after repair will not be extended beyond the original one-year period.
- All replacement parts will be new or reconditioned.
- Parts, which are replaced, become the property of Sunpentown.
- The warranty applies for the use of the product in the USA only.

What is NOT COVERED:

- Warranty does not include freight charges.
- Incidental or consequential damage caused by possible defects with this product.
- Damage to product caused by improper power supply voltage, accident, fire, floods or acts of nature.
- Failure of product resulting from unauthorized modifications to the product.
- Improper installation or failure to perform the necessary maintenance.

This GUARANTEE is in addition to your Statutory Rights

SUNPENTOWN INTERNATIONAL INC.
14625 Clark Ave, City of Industry, CA 91745
Tel: 1-800-330-0388
service@sunpentown.com
www.sunpentown.com