

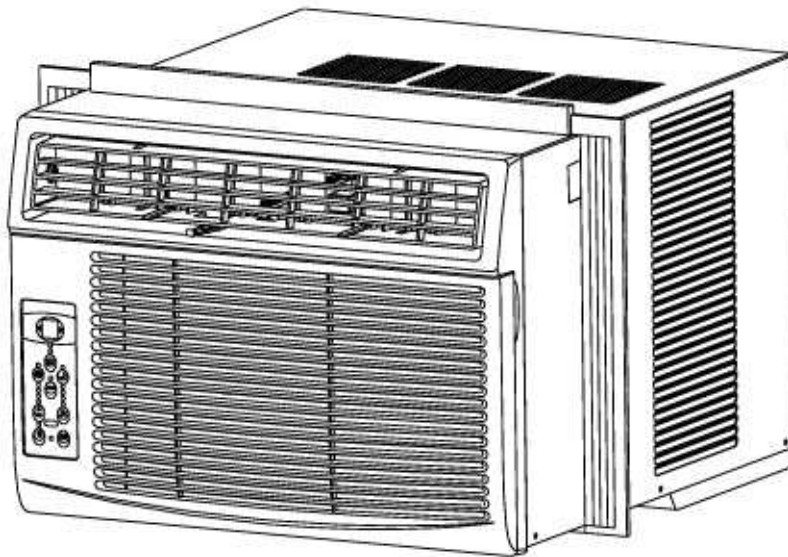

WINDOW / WALL-TYPE ROOM AIR CONDITIONER



WA-6011S: 6000 BTU
WA-8011S: 8,000 BTU
WA-1011S: 10,000 BTU
WA-1211S: 12,000 BTU

Thank you for your purchase. Before using your air conditioner, please read this manual carefully and keep it for future reference.

CONTENTS

1. SAFETY PRECAUTIONS	2
2. IMPORTANT SAFETY INSTRUCTIONS	3
3. NORMAL SOUNDS	4
4. AIR CONDITIONER FEATURES	4
5. INSTALLATION INSTRUCTIONS.....	9
6. CARE AND CLEANING.....	12
7. TROUBLESHOOTING TIPS.....	13
8. SPECIFICATIONS.....	14
9. REMOTE CONTROL.....	15

READ THIS MANUAL

Inside you will find many helpful hints on how to use and maintain your air conditioner properly. Just a little preventive care on your part can save you a great deal of time and money over the life of your air conditioner. You'll find many answers to common problems in the chart of troubleshooting tips. If you review our chart of Troubleshooting Tips first, you may not need to call for service at all.



CAUTION

- Contact the authorized service technician for repair or maintenance of this unit.
- Contact the installer for installation of this unit.
- The air conditioner is not intended for use by young children of infirm persons without supervision.
- Young children should be supervised to ensure that they do not play with the air conditioner.
- If the power cord is to be replaced, replacement work is to be performed by authorized personnel only.
- Installation work must be performed in accordance with the national wiring standards, by authorized personnel.



Note: All illustrations in this manual are for explanation purposes only. Your air conditioner may be slightly different. The actual shape shall prevail.

The manual provides specific operating instructions. Use the air conditioner only as instructed in the manual. These instructions are not meant to cover every possible condition and situation that may occur. Common sense and caution must be practice when installing, operating and maintaining any appliance.

SAFETY PRECAUTIONS

To prevent injury or property damage, the following instructions must be followed. Failure to follow instructions and incorrect operation may cause harm or damage.

Warning marks and classification:

 WARNING	Indicates possibility of death or serious injury.
 CAUTION	Indicates possibility of injury or property damage.

WARNING

- Ensure plug is firmly connected to prevent electric shock or fire due to excess heat generation.
- Never operate or stop the unit by inserting or removing the power plug.
- Do not operate if cord or plug is damaged or after the appliance malfunctions in any manner. Contact the manufacturer or similarly qualified technician.
- Never modify or alter the power cord in any way.
- Do not use an extension cord or an adapter plug.
- Use a dedicated circuit to avoid possibility of an electrical surge.
- Do not operate with wet hands or in a damp environment.
- For health purposes, do not direct airflow directly at room occupants.
- The air conditioner must be properly grounded.
- Do not splash water onto the unit or allow water to get into the electric parts.
- Unplug unit immediately if strange sound, smell or smoke is emitting from unit.
- Never open or remove the housing while in operation.
- Keep firearms, combustibles and flammable gas away from unit.
- Keep power cord away from heat sources.
- If there was a gas leak from another appliance, ventilate the room thoroughly before operating the unit.
- Do not disassemble or modify the unit.

CAUTION

- When cleaning the filter, be cautious of sharp edges and corners.
- Never clean the unit by spraying water onto the unit, especially the control panel.
- When used in the same room with a stove operating, keep room ventilated to prevent oxygen shortage.
- Always turn unit off and unplug power source before cleaning and maintenance.
- Do not expose pet or plant in direct airflow of the unit.
- Not intended for special purposes. Do not use this air conditioner to preserve precision devices, food, pets, plants and art objects. May cause deterioration of quality.
- Disconnect during thunderstorms and hurricane.
- Remove plug from wall outlet by grasping the plug, never remove by pulling on the cord.
- Do not block air inlets and outlets.
- Inspect the brackets frequently to ensure no damages occurred due to prolonged exposure.
- Clean filter once every two weeks. Be sure filter is replaced properly.
- Never clean the unit with harsh chemicals or abrasive scouring pads or powders.
- Do not consume the water drained from the air conditioner.

IMPORTANT SAFETY INSTRUCTIONS

NOTE: For some models, the power supply cord with this air conditioner contains a current detection device designed to reduce the risk of fire. Please refer to the section “Operation of Current Device” for details. In the event that the power supply cord is damaged, it cannot be repaired – it must be replaced with a cord from the Product Manufacturer.

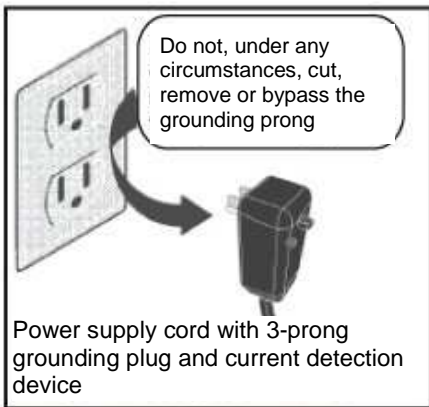

WARNING – For Your Safety

- Do not store or use gasoline or other flammable vapors and liquids in the vicinity of this or any other appliance.
- Avoid fire hazard or electric shock. Do not use an extension cord or an adaptor plug. Do not remove any prong from the power cord.

WARNING – Electrical Information

- Be sure the electrical service is adequate for the model you have chosen. This information can be found on the serial plate, which is located on the side of the cabinet and behind the grille.
- Be sure the air conditioner is properly grounded. To minimize the shock and fire hazards, proper grounding is important. The power cord is equipped with a three-prong grounding plug for protection against shock hazards.
- Your air conditioner must be used in a properly grounded wall receptacle. If the wall receptacle you intend to use is not adequately grounded or protected by a time delay fuse or circuit breaker, have a qualified electrician install the proper receptacle.
- Ensure the receptacle is accessible after the unit installation.
- Do not run air conditioner without side protective cover in place. This could result in mechanical damage within the air conditioner.
- **Do not use an extension cord or an adapter plug.**

Operation of Current Device

The power supply cord contains a current device that senses damage to the power cord. To test your power supply cord do the following:

1. Plug in the Air Conditioner.
2. The power supply cord will have TWO buttons on the plug head. Press the TEST button, you will notice a click as the RESET button pops out.
3. Press the RESET button and you will notice another click as the button engages.
4. The power supply cord is now supplying electricity to the unit. (On some products, this is also indicated by a light on the plug head.)

NOTES:

- Do not use this device to turn the unit on or off.
- Always make sure the RESET button is pushed in for correct operation.
- The power supply must be replaced if it fails to reset when TEST button is pushed or when it cannot be reset. A new one can be obtained from the product manufacturer.

NOTE: This air conditioner is designed to operate under condition as follows:

Cooling operation	Outdoor temp	64~109°F (T ₁ Environment)
	Indoor temp	62~89°F (T ₁ Environment)

Note: Performance may be reduced outside of these operating temperatures.

NORMAL SOUNDS

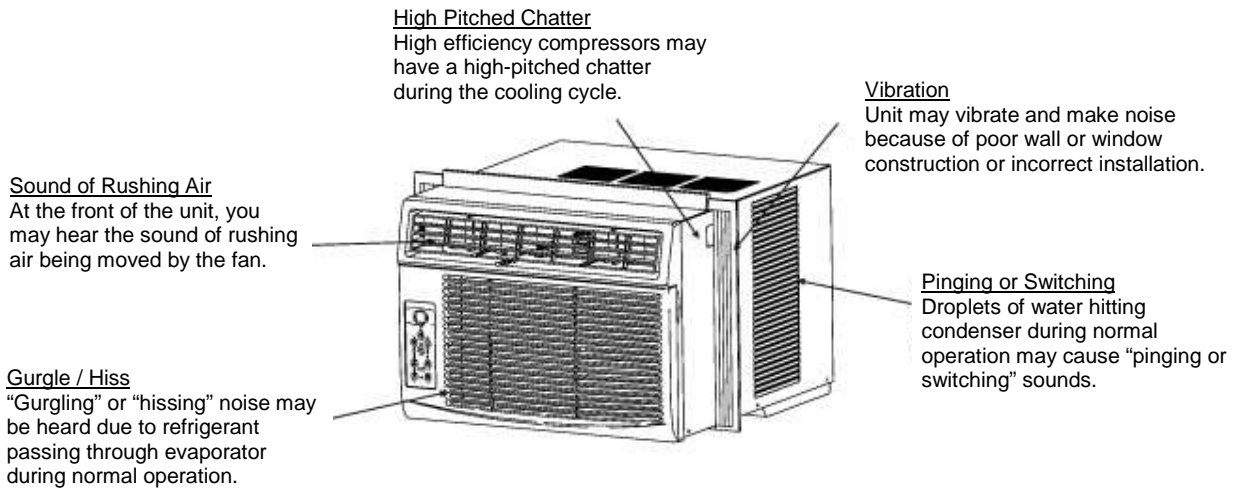

AIR CONDITIONER FEATURES

ELECTRONIC CONTROL OPERATING INSTRUCTIONS

Before you begin, thoroughly familiarize yourself with the control panel and remote as shown below and all its functions, then follow the symbol for the functions you desire. **The unit can be controlled by the unit control alone or with the remote.**

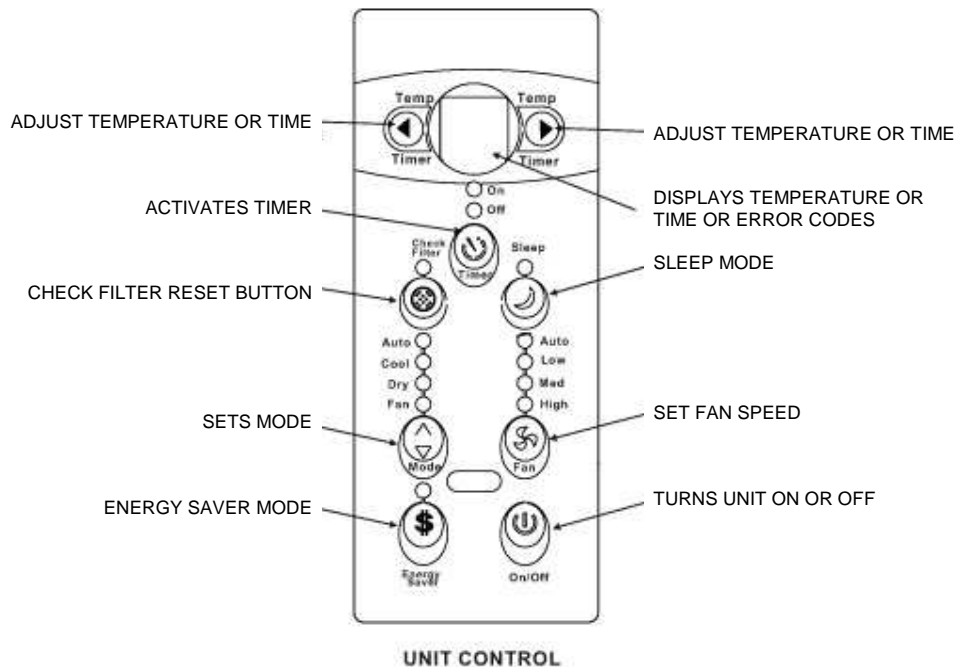

NOTE: All illustrations are for explanation purposes only. The actual appearance of the unit control may differ slightly, though functions and operations are the same

AIR CONDITIONER FEATURES (CONTINUED)

NOTE: The following instruction represent the Unit Controls, the same instructions can be used for the Remote Control.

TO TURN UNIT ON:

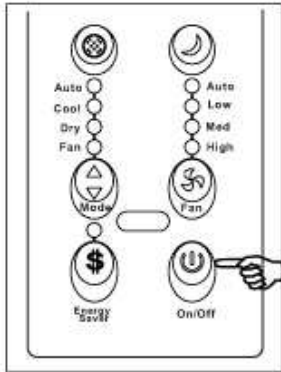

DO THIS:
Press the On/Off button.

TO CHANGE TEMPERATURE SETTING:

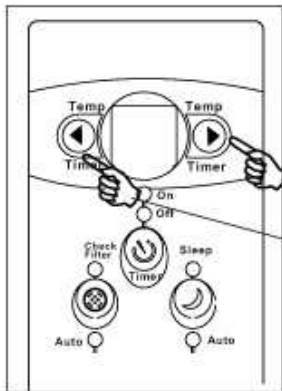

DO THIS:
Press to increase
Press to lower

NOTE:
Press or hold either Left (<) or Right (>) button until the desired temperature is seen on the display. This temperature will be automatically maintained anywhere between 62°F (17°C) and 86°F (30°C). If you want the display to read the actual room temperature, see "To Operate on Fan Only" section.

TO ADJUST FAN SPEEDS:

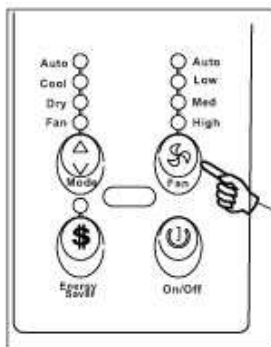

DO THIS:
Press to select appropriate fan speed

NOTE:
Select Fan Speed in four steps – Auto, Low, Med or High. Each time the button is pressed, the fan speed mode is shifted. In Dry mode, the fan speed is set at Low automatically.

AIR CONDITIONER FEATURES (CONTINUED)

TO SELECT THE OPERATING MODE:

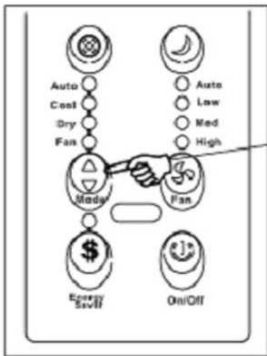

DO THIS:
Press the Mode button.

NOTE:

- Press the Mode button to select operating mode. With each press of the button, the mode will go through the following sequence: Auto, Cool, Dry and Fan. The indicator light next to each corresponding mode will illuminate

AUTO mode:

- When the air conditioner is set in AUTO mode, unit will automatically select Cooling or Fan operation, depending on set and ambient temperature.
- Set temperature range is 62~86°F.
- Unit engages COOL mode when ambient temperature is 4°F above set temperature. And when ambient temperature falls 2°F below set temperature, unit will switch to FAN.
- Fan speed cannot be adjusted in AUTO mode.

COOL mode:

- Set temperature range is 62~86°F.
- Unit begins Cooling when ambient temperature is 2°F above set temperature. Cooling stops and unit switches to Fan when set temperature has been reached.
- Fan speed can be selected

AUTO vs. COOL (example with set temp @ 70°F)

AUTO: Cools down to 68°F → Fan, up to 74°F → Cool

COOL: Cools down to 70°F → Fan, up to 72°F → Cool

FAN only mode:

- Use this function when cooling is not desired, such as for air circulation. Best to open windows when operating in Fan only mode but remember to close windows in Cooling mode for maximum cooling efficiency.
- Fan speed can be adjusted.
- In Fan mode, the display will show actual room temperature.
- Temperature cannot be set or adjusted.

ENERGY SAVER FEATURE:

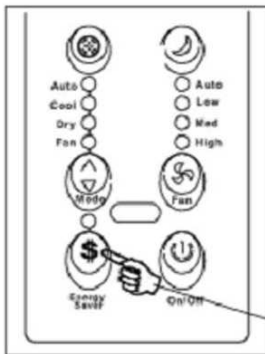

DO THIS:
Press the button.

DRY mode:

- In this mode, the air conditioner will generally operate in the form of a dehumidifier. Since the conditioned space is closed or sealed area, some degree of cooling will continue.

ENERGY SAVER feature:

This feature can be selected when unit is in COOL mode. When the set temperature has been reached and compressor shuts off, fan will continue to run for another 3 minutes, then cycles on for 2 minutes at 10-minute intervals until the room temperature has rise above set temperature, at which point the compressor turns back on and Cooling resumes.

AIR CONDITIONER FEATURES (CONTINUED)

SLEEP FEATURE:

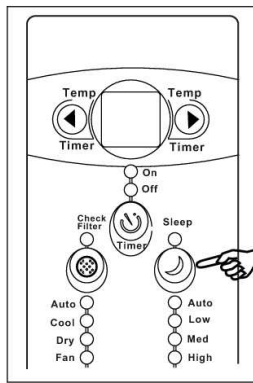

DO THIS:
Press Sleep button.

SLEEP feature:

When selected in conjunction with COOL mode:

- Unit will operate at set temperature for 30 minutes.
- After 30 minutes, unit will increase temperature by 2°F. After another 30 minutes, unit will again increase temperature by 2°F.
- Unit will operate at the new temperature for 6 hours.
- After 6 hours, unit will return to original setting and continue to operate as originally programmed. This ends the SLEEP feature.
- SLEEP feature can be cancelled at any time during operation by pressing the SLEEP button again.

TIMER: AUTO START/STOP FEATURE:

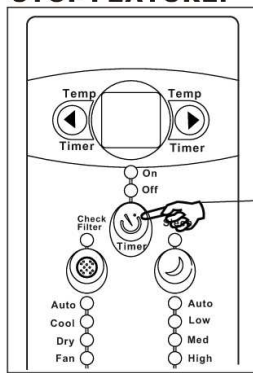

DO THIS:
Press Timer button.

TIMER feature:

- Press the TIMER button to program Auto-Start or Auto-Off. The corresponding indicator light will illuminate.
- Use the UP/DOWN arrow buttons to program. Each press is increment of 0.5 hours up to 10 hours, then in increments of 1 hour up to 24 hours.
- Unit will register timer setting after 5 seconds. If unit is on, display will revert back to previous temperature setting. If unit is off, there will be no display.
- Turning the unit ON or OFF or adjusting the timer to 0 will cancel the timer program.

CHECK FILTER FEATURE:

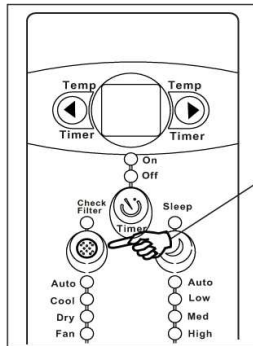

DO THIS:
Press Check Filter button.

FILTER CHECK feature:

This feature is a reminder to clean the Air Filter for more efficient operation. The LED light will illuminate after 250 hours of operation. Once the filter has been cleaned, press the Check Filter button to reset.

DISPLAYS:

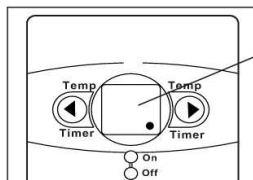

Display

DISPLAY:

- COOL mode: displays set temperature in °C or °F and timer.
- FAN mode: displays ambient temperature

Error Codes:

“AS” = room temperature sensor error. Disconnect unit from power source, wait 3 minutes and plug back in. If error persists, call for service.

“.” = evaporator temperature sensor error. Disconnect unit from power source, wait 3 minutes and plug back in. If error persists, call for service. (As shown in image to the left)

ADDITIONAL THINGS YOU SHOULD KNOW

Now that you have mastered the operating procedures, here are some additional features:

- The Cool circuit has an automatic 3-minute time delay when unit is turned off and on quickly. This protects the compressor from overheating and possible circuit breaker tripping. The fan will continue to run during this time.
- The LCD is capable of displaying temperature in °F or °C. To switch the temperature scale, press and hold both UP and DOWN buttons simultaneously for 3 seconds.

Fresh Air Vent Control (WA-1011S and WA-1211S models only)



Figure 1 (VENT CLOSED)



Figure 2 (VENT OPEN)

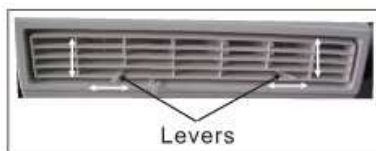

Figure 3 (VENT & EXHAUST OPEN)

The Fresh Air Vent allows the air conditioner to:

1. Circulate indoor air – vent closed (Fig.1)
2. Draw fresh air into the room – vent open (Fig.2)
3. Indoor and outdoor air exchange – vent & exhaust open (Fig.3)

Air Directional Louvers



Air Direction

Directional louvers can be adjusted Left or Right and Up or Down (not all models).

INSTALLATION INSTRUCTIONS

Your air conditioner is designed install in standard double hung windows with opening widths of 23 to 36 inches (584mm to 914mm) (See Fig.1)

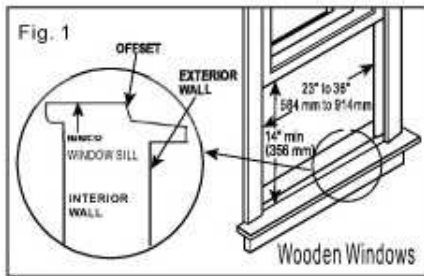

Lower sash must have sufficient vertical opening for installation (Table 1). Side and rear of unit needs to be clear of obstacles to allow airflow through condenser. The rear of the unit must be outdoors, not inside a building or garage.

Table 1

Model	WA-6011S	WA-8011S	WA-1011S/WA-1211S
Minimum vertical opening	13" (330mm)	14" (356mm)	15-1/2" (394mm)

NOTE: Save carton and these installation instructions for future reference. The carton is the best way to store unit during winter, or when not in use.

TOOLS NEEDED:

- Phillips screwdriver
- Drill (if pilot holes are needed)

CAUTION: When handling unit, be careful to avoid cuts from sharp metal edges and aluminum fins on front and rear coils.

NOTE: The top rail hardware and the following Fig.A, Fig.B and Fig.C are not applicable to the units more than 10000Btu/h.

Before installing unit, the top rail must be assembled:

(WA-6011S and WA-8011S only)

Tool Needed: Phillips Screwdriver

- A. Remove unit from packaging and place on a flat surface.
- B. Remove the top rail from rear of the packaging material. (Fig.A)
- C. Align screw openings on the top rail to those on the top of the unit. (Fig.B)
- D. Secure top rail to unit with supplied 3/8" screws (Fig.C)

NOTES: For safety reasons, all four (4) screws **MUST** be securely fastened.

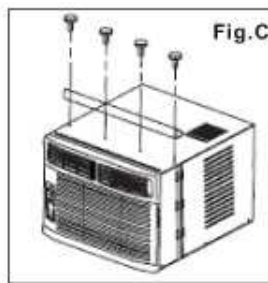
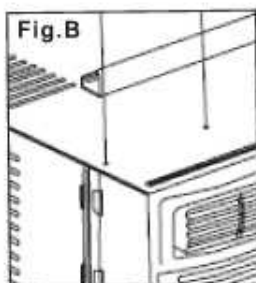
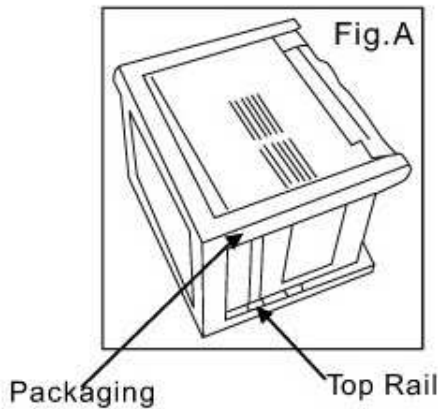
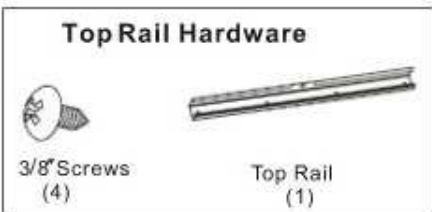

INSTALLATION

NOTE: Top rail and side panels are offset to provide the proper pitch to the rear (5/16"). This is necessary for drainage of water condensation. If the side panels are not used, this pitch still needs to be maintained.

1. Place unit on floor or sturdy table. Install the side panels, the panels are indicated Left or Right – be sure to use the proper panel for each side. When properly installed, the flange for securing the panel to windowsill should face into the room.

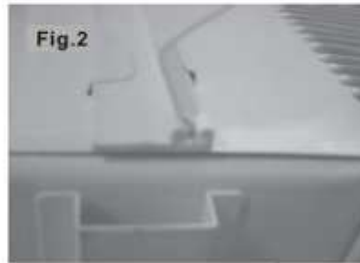

- 1a. Hold panel firmly in one hand and gently pull back the accordion curtain with other hand. (Fig.1)

- 1b. Slide the panel (open end toward unit) into the guides on the air conditioner (Fig.2 and Fig.3)



- 1c. Once installed, check to make sure panel sits securely within the guides. (Fig.4)
- 1d. Slide the panel all the way in and repeat with other side.
3. With a firm grip on the air conditioner, carefully place the unit into the window opening. The bottom of the air conditioner frame should sit against the windowsill. (Fig.5) Carefully bring the window sash down behind the top rail.
2. Extend the side panels out against the window frame. (Fig.6)

Note: If storm window blocks AC, refer to Fig.13.

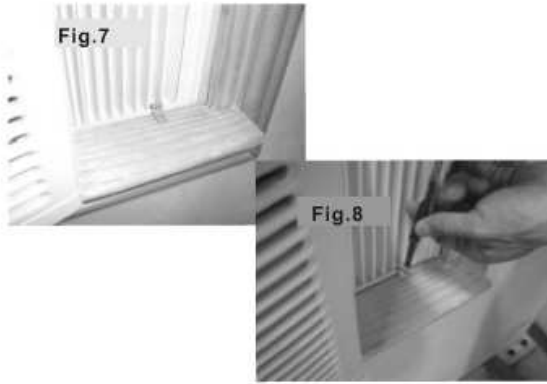

7. Install frame lock between the frame extension and the windowsill. Drive a 3/4" (19mm) locking screw through the frame lock and into the sill (Fig.7&8)

Note: To prevent the windowsill from splitting, first drill a 1/8" (3mm) pilot hole.

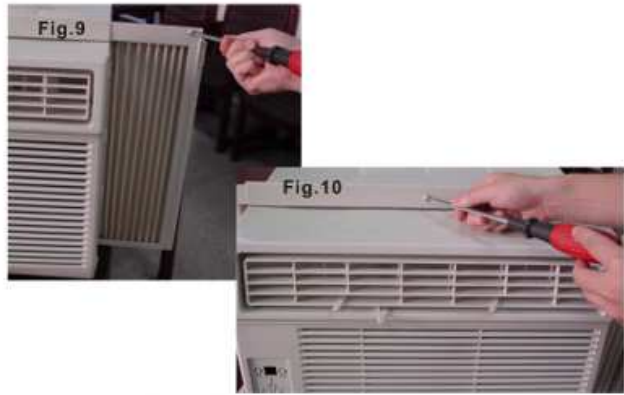

6. Insert and secure 1/2" (13mm) locking screws through frame holes into window sash. (Fig.9&10)



5. To secure lower sash in place, attach the Sash Lock with 3/4" (19mm) screws. (Fig.11)

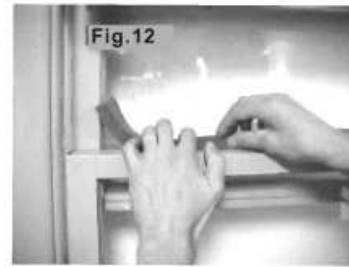

4. Trim foam seal to size and insert in the space between the upper and lower sashes. (Fig.12)

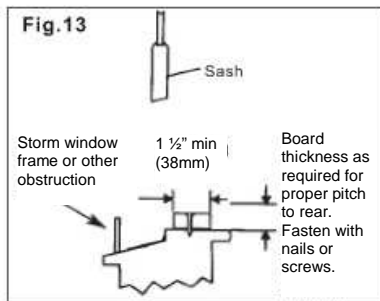

IF AC IS BLOCKED BY STORM WINDOW

Add wood as shown in Fig.13, or remove storm window before installation.

If storm window must remain, be sure the drain holes or slots are not caulked or painted shut. Accumulated water or condensation must be allowed to drain out.

REMOVING AC FROM WINDOW

- Turn AC off and disconnect from power source.
- Remove sash seal from between window sashes.
- Unscrew and remove Sash Lock and Frame Lock.
- Slide side panels into frame.
- Keeping a firm grip on the air conditioner, raise window sash and carefully tilt unit backwards to drain any water condensation. Carefully lift unit from window opening. Store parts with air conditioner.

CARE AND CLEANING

CAUTION

Clean your air conditioner occasionally to keep looking new. **Be sure to unplug the unit before cleaning to prevent shock or fire hazards.**



Air Filter Cleaning

The air filter should be checked at least once a month to see if cleaning is necessary. Trapped particles in the filter can build up and cause an accumulation of frost on the cooling coils

- Push the vent handle to the Vent Closed position (where applicable).
- Open the front panel.
- Grasp the filter by the center and pull up and out.
- Wash the filter using liquid dishwashing detergent and warm water. Rinse filter thoroughly.
- Gently shake excess water from the filter. Be sure the filter is thoroughly dry before replacing.
- Instead of washing, you may also vacuum the filter clean.

NOTE: Never use hot water over 40°C (104°F) to clean the air filter. Never attempt to operate the unit without the air filter.

Cabinet Cleaning

- Be sure to unplug the air conditioner to prevent shock or fire hazard. The cabinet and front may be dusted with an oil-free cloth or wiped with a cloth dampened in solution of warm water and mild dishwashing detergent. Then wipe clean and dry thoroughly.
- Never use harsh cleaners, wax or polish on the cabinet front.
- Be sure to wring excess water from the cloth before wiping around the controls. Excess water in or around the controls may cause damage to the air conditioner.

Winter Storage

If you plan to store the air conditioner during the winter, remove it carefully from the window according to the installation instruction. Cover it with plastic or return it to the original carton.

TROUBLESHOOTING TIPS

Before calling for service, review this list, it may save you time and expense. This list includes common occurrences that are not the result of defective workman-ship or materials in this appliance.

Problem	Solution
Air conditioner does not start	<ul style="list-style-type: none"> ▪ Wall plug disconnected. Push plug firmly into wall outlet. ▪ House fuse blown or circuit breaker tripped. Replace fuse with time delay type or reset circuit breaker. ▪ Plug Current Device tripped, press the RESET button. ▪ Control is OFF, turn control ON and set to desired setting.
Air from unit does not feel cold enough	<ul style="list-style-type: none"> ▪ Room temperature below 17°C (62°F). Cooling may not occur until room temperature rises above 17°C (62°F). ▪ Temperature sensing element is touching the cooling coil, located behind air filter. Gently bend the element away from cooling coil. ▪ Set temperature has been reached. Lower set temperature. ▪ Compressor shut-off due to mode change. Wait approximately 3 minutes and listen for compressor to restart in COOL mode.
Air conditioner cooling, but room is too warm. Ice forming on cooling coil behind decorative front	<ul style="list-style-type: none"> ▪ Outdoor temperature below 18°C (64°F). To defrost the coil, set FAN only mode. ▪ Air filter may be dirty, clean filter. Refer to Care and Cleaning section. ▪ Thermostat set too cold for nighttime cooling, set a higher temperature. ▪ To defrost the coil, set to FAN only mode.
Air conditioner cooling, but room is too warm. NO Ice forming on cooling coil behind decorative front	<ul style="list-style-type: none"> ▪ Air filter is dirty and restricting air flow. Clean air filter. ▪ Temperature is set too high, set to a lower temperature setting. ▪ Air directional louvers positioned improperly. Position louvers for better air distribution. ▪ Front of unit is blocked and airflow restricted. Clear blockage such as drapes, blinds, furniture, etc. ▪ Doors/windows are open, allowing cold air to escape. Close doors/windows. ▪ Unit recently turned on in hot room, allow additional time to remove “stored heat” from walls, ceiling, floor and furniture.
Air conditioner turns on and off rapidly	<ul style="list-style-type: none"> ▪ Dirty air filter restricting airflow. Clean air filter ▪ Outside temperature extremely hot. Set FAN speed to a higher setting to bring air past cooling coils more frequently.
Noise when unit is cooling	<ul style="list-style-type: none"> ▪ Air movement sound. This is normal. If too loud, set to a slower FAN setting. ▪ Window vibration – poor installation. Refer to installation guide or check with installer.
Water dripping INSIDE when unit is cooling	<ul style="list-style-type: none"> ▪ Improper installation. Tilt air conditioner slightly toward the outside to allow water drainage. Refer to installation instructions or check with installer.

Problem**Solution**

**Water dripping
OUTSIDE when unit is
cooling**

- Unit removing large quantity of moisture from humid room. This is normal during excessively humid days.

**Remote sensing
deactivating
prematurely (some
models)**

- Remote control not used within range. Place remote control within 20 feet and 180° radius to the front of the unit.
- Remote control signal obstructed. Remove obstruction

Room too cold

- Set temperature too low, increase set temperature.

SPECIFICATIONS

MODEL	WA-6011S	WA-8011S	WA-1011S	WA-1211S
Energy Star	✓	✓	✓	✓
Cooling (BTU)	6000	8000	10000	12000
Dehumidify (pints/hr)	1.3	1.7	2.7	3.2
EER (BTU/H.W.)	10.7	10.8	10.8	10.8
Power Input	115V~, 60Hz	115V~, 60Hz	115V~, 60Hz	115V~, 60Hz
Amps	5.4	7	8.8	10.2
Watts	560	740	930	1110
Power Cord Length	6 ft	6 ft	6 ft	6 ft
NEMA Plug Type	LCDI 5-15P, 10A	LCDI 5-15P, 13A	LCDI 5-15P, 15A	LCDI 5-15P, 15A
Unit Dimension (W x H x D) in.	16.25 x 12.31 x 15.75	19.13 x 12.8 x 15.75	19.69 x 14.75 x 20.94	19.69 x 14.75 x 20.94
Packing Dimension (W x H x D) in.	18 x 14.5 x 17	22 x 14.5 x 18	22 x 17 x 23	22 x 17 x 23
Net/Gross Weight (lbs)	40/45	46/55	58.5/65	68/75
Window Width (Min / Max)	23 / 36 in.	23 / 36 in.	23 / 36 in.	23 / 36 in.
Window Height (Min)	13 in.	14 in.	15.5 in.	15.5 in.
Refrigeration	R410A	R410A	R410A	R410A
Air Flow (M3/H)	250	380	500	500
Noise (dB)	55.6/53.4/51.3	60.5/57.3/53.2	59.3/56.1/51.4	58.9/55.7/51.2
Fan Speeds	3	3	3	3
Dry Modes	✓	✓	✓	✓
Auto Mode	✓	✓	✓	✓
Energy Saver	✓	✓	✓	✓
Sleep Mode	✓	✓	✓	✓
Auto Restart	✓	✓	✓	✓
Filter Check	250 hours	250 hours	250 hours	250 hours
24hr On/Off Timer	✓	✓	✓	✓
Directional Louver	Left-Right	Left-Right / Up-Down	Left-Right / Up-Down	Left-Right / Up-Down
Filter Access	Slide-out	Tilt-out	Tilt-out	Tilt-out

REMOTE CONTROL

HANDLING THE REMOTE CONTROLLER



Location of the remote controller

- Use the remote control within a distance of 5 meters (5.5 yards) from the appliance, pointing toward the receiver. Reception is confirmed by a beep.

CAUTIONS

- The air conditioner will not operate if curtains, doors or other materials block the signals from the remote controller to the indoor unit.
- Prevent any liquid from falling into the remote controller. Do not expose the remote controller to direct sunlight or heat.
- If the infrared signal receiver on the indoor unit is exposed to direct sunlight, the air conditioner may not function properly. Use curtains to prevent the sunlight from falling on the receiver.
- If other electrical appliances react to the remote controller, either move these appliances or consult your local dealer.

REPLACING BATTERIES

The remote controller is powered by two AAA batteries (not included) housed in the rear and protected by a cover.

- (1) Remove the cover by pressing and sliding off.
- (2) Remove old batteries and insert new batteries – placing the (+) and (-) ends correctly.
- (3) Replace cover by sliding it back into position.

NOTE: When batteries are removed, all programming are erased. After inserting new batteries, the remote controller must be reprogrammed.

REMOTE CONTROLLER SPECIFICATIONS

Rated Voltage	3.0V (Dry batteries Lr03x2)
Lowest Voltage of CPU Emitting Signal	2.4V
Signal Receiving Range	5m
Environment	-5°C ~ 60°C (23°F ~ 140°F)

Note: All illustrations are for explanation purposes only. The actual shape of remote may be slightly different.

Remote Functions

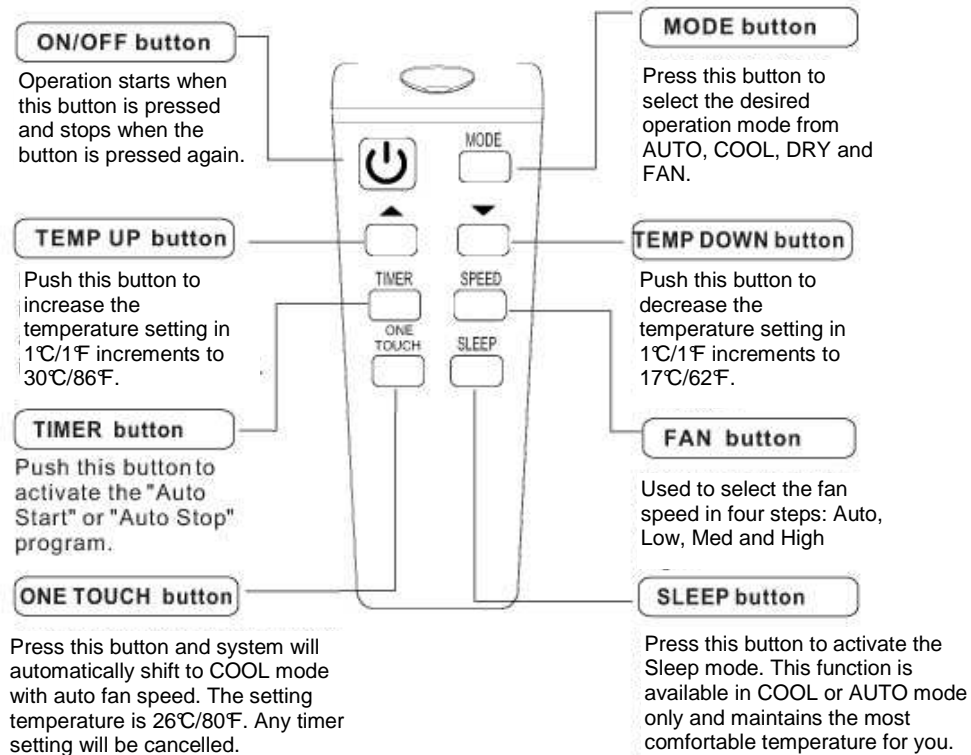

Using the Remote

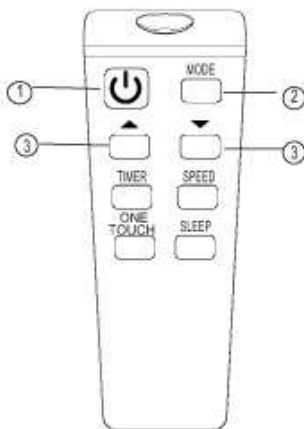

Auto Operation

Ensure the unit is plugged in and power is available.

1. Press the ON/OFF button to start the air conditioner.
2. Press the MODE button to select AUTO.
3. Press the TEMP UP/DOWN button to set desired temperature.

The temperature can be set within the range of 17~30°C/62~86°F in 1°C/1°F increments.

NOTE

- In Auto mode, the unit will choose the operating mode (Cooling or Fan) by sensing the difference between actual ambient temperature and set temperature on the remote
- In Auto mode, fan speed cannot be changed.
- If the Auto mode is not comfortable for you, select desired mode and set temperature manually.

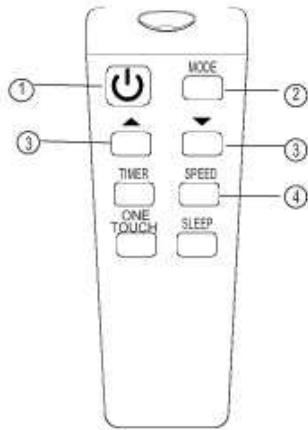

Cooling and Fan Operation

- Ensure the unit is plugged in and power is available.
- 4. Press the ON/OFF button to start the air conditioner.
- 5. Press the MODE button to select COOL or FAN mode.
- 6. In COOL mode, press the TEMP UP/DOWN button to set desired temperature. Temperature can be set within the range of 17~30°C/62~86°F in 1°C/1°F increments.
- 7. Press FAN button to select fan speed in four steps: Auto, Low, Med, or High.

NOTE

In Fan mode, temperature setting is not available, only steps 1, 2 and 4 may be performed.

Please refer to page 6 for details on AUTO and COOL setting.

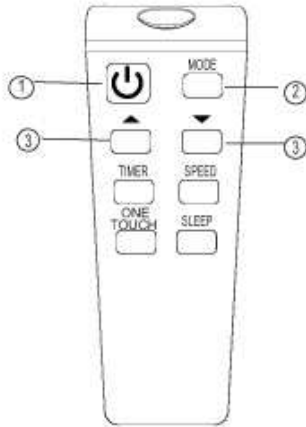

Dehumidifying Operation

- Ensure the unit is plugged in and power is available.
- 1. Press the ON/OFF button to start the air conditioner.
- 2. Press the MODE button to select DRY mode.
- 3. Press the TEMP UP/DOWN button to set desired temperature. Temperature can be set within the range of 17~30°C/ 62~86°F in 1°C/1°F increments.

NOTE

In Dry mode, fan speed cannot be selected.

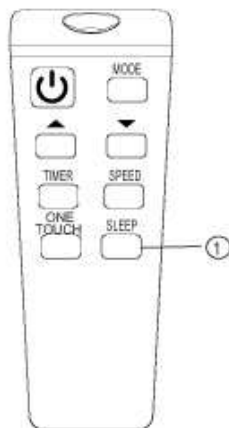

Sleep Operation

- 1. Press this button to activate the Sleep mode. This function is available in COOL or AUTO modes only and will maintain the most comfortable temperature for you.
- 2. In this mode, unit will run at your set temperature for 30 minutes. After the initial 30 minutes, unit will increase set temperature by 1°C/2°F. After another 30 minutes, unit will again increase temperature by 1°C/2°F. Unit will then maintain this new temperature for 6 hours and return to original temperature setting. This ends the Sleep mode.

NOTE

Sleep mode is cancelled when any of these buttons are pressed: MODE, ON/OFF, FAN SPEED and SLEEP.

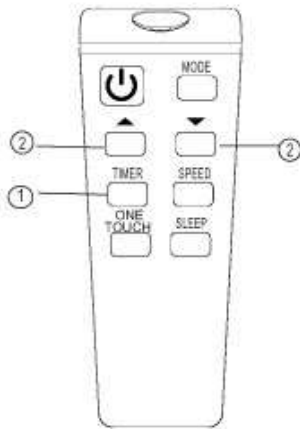

Timer Operation

Press the TIMER button to initiate the Auto-Start or Auto-Off program. Timer can be set up to 24 hours.

1. Press the TIMER button to program Timer-On or Timer-Off, the corresponding indicator will illuminate on unit's control panel.
2. Press or hold the UP/DOWN button to program time in 0.5 hour increments, up to 10 hours, then in 1 hour increments up to 24 hours. Control will count down the remaining time till start/stop.
3. The programmed time will register after 5 seconds and panel will revert back to displaying the previous temperature setting.
4. Turning the unit ON or OFF at any time will cancel programmed Timer.

NOTE

To cancel TIMER setting, press the TIMER button while pressing either UP or DOWN button until 0 hour is displayed.

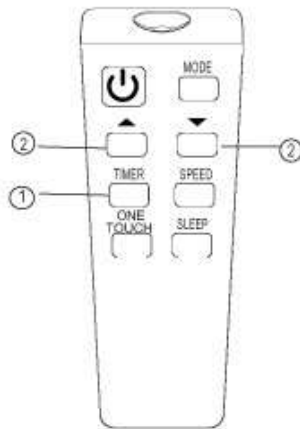

Combined Timer

You can program both Timer-On and Timer-Off simultaneously

AUTO OFF → AUTO START

This feature is useful when you want to stop the air conditioner after you go to bed and start it again in the morning or when you return home from work. Example: To stop the air conditioner after 2 hours and start it again in 10 hours:

1. Press the TIMER button until the TIMER-OFF indicator is displayed on unit's control panel.
2. Use the UP/DOWN button to set "2.0" hours.
3. Press the TIMER button again until TIMER-ON is displayed on control panel.
4. Use the UP/DOWN button to set "10" hours.
5. Wait for 5 seconds for program to be registered and panel to revert back to previous display.

AUTO START → AUTO OFF

This feature is useful when you want to start the air conditioner before you wake up and stop it after you leave the house.

Example: To start the air conditioner in 5 hours and stop it after 8 hours:

1. Press the TIMER button until the TIMER-ON indicator is displayed on unit's control panel.
 2. Use the UP/DOWN button to set "5.0" hours.
 3. Press the TIMER button again until TIMER-OFF is displayed on control panel.
 4. Use the UP/DOWN button to set "8" hours.
- Wait for 5 seconds for program to be registered and panel to revert back to previous display.



Your Guarantee

If this product is found to be faulty as a result of faulty materials or workmanship within one year from date of purchase, it will be repaired free of charge.

This guarantee is subject to the following terms:

- Sunpentown must be notified of the fault.
- Proof of purchase must be presented to Sunpentown's nominated representative.
- The warranty will be void if the product is modified, misused or repaired by an unauthorized person.
- The warranty after repair will not be extended beyond the original one-year period.
- All replacement parts will be new or reconditioned.
- Parts, which are replaced, become the property of Sunpentown.
- The warranty applies for the use of the product in the USA only.

What is NOT COVERED:

- Warranty does not include freight charges.
- Incidental or consequential damage caused by possible defects with this product.
- Damage to product caused by improper power supply voltage, accident, fire, floods or acts of nature.
- Failure of product resulting from unauthorized modifications to the product.
- Improper installation or failure to perform the necessary maintenance.

This GUARANTEE is in addition to your Statutory Rights

SUNPENTOWN INTERNATIONAL INC.
Tel: 800-330-0388
14625 Clark Ave., City of Industry CA 91745
service@sunpentown.com
www.sunpentown.com