

VS-222007

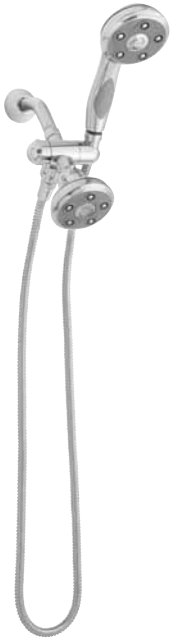

VS-223010



VS-223011



VS-223014



Diverter Mount Combination Units

GENERAL SPECIFICATION

Chrome plated 3-way shower diverter. Anystream massage hand showers mounted to a 3-way diverter bracket. Units include a fixed showerhead, 5' metal hose, and vacuum breaker. Showerheads are equipped with 2.5 gpm flow controls to meet ASME A112.18.1/CSA B125.1 standards.

VS-222007 

Chrome plated diverter mount combination unit with S-2007 showerhead and VS-2007 hand shower.

VS-223010 

Chrome plated diverter mount combination unit with S-3010 showerhead and VS-3010 hand shower.

VS-223011 

Chrome plated diverter mount combination unit with S-3011 showerhead and VS-3011 hand shower.

VS-223014 

Chrome plated diverter mount combination unit with S-3014 showerhead and VS-3020 hand shower.

OPTIONS

SUFFIX	DESCRIPTION
<input type="checkbox"/> BN	Brushed nickel finish
<input type="checkbox"/> PB	Polished brass finish (VS-222007 only)

This space for Architect/Engineer approval.



SPEAKMAN ALEXANDRIA™

Accessories

SPECIFICATION

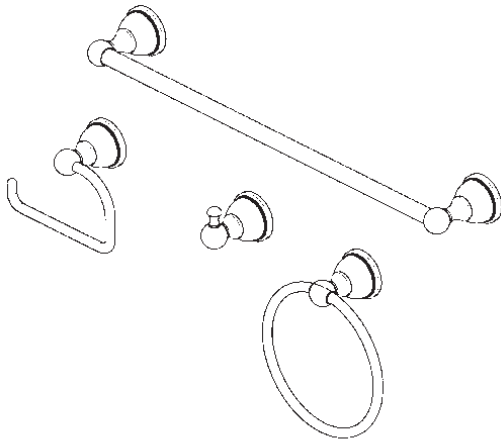

FEATURES:

- SA-1107: 24" towel bar
- SA-1104: Towel ring
- SA-1105: Paper holder
- SA-1106: Robe hook
- Metal construction

AVAILABLE FINISHES:

ADD SUFFIX TO MODEL #

- Polished Chrome (standard)
- Brushed Nickel -BN

WARRANTY:

- 1 year limited

Robe Hook
SA-1106

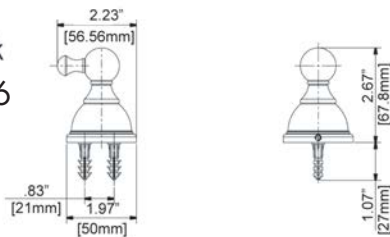

Towel Ring
SA-1104

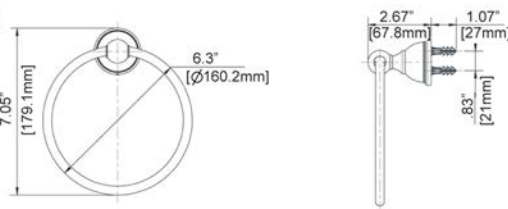

Tissue Holder
SA-1105

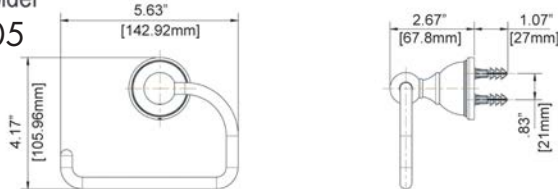

Towel Bar
SA-1107

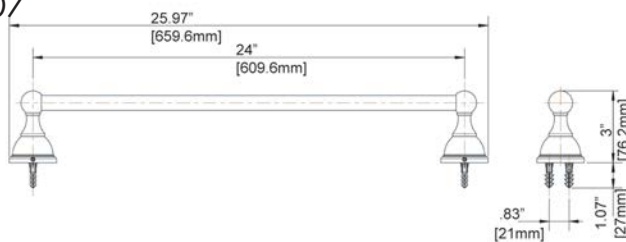

NOTE: 1. All dimensions are in inches (millimeters) unless otherwise specified and are subject to change without notice.

THIS SPACE FOR ARCHITECT/ENGINEER APPROVAL.

SPEAKMAN®

400 ANCHOR MILL ROAD | NEW CASTLE, DE 19720
P: 800-537-2107 | F: 800-977-2747
WWW.SPEAKMANCOMPANY.COM



REVISION DATE: DEC. 2012

SPEAKMAN ALEXANDRIA™

8" Widespread Faucet SB-1121

SPECIFICATION

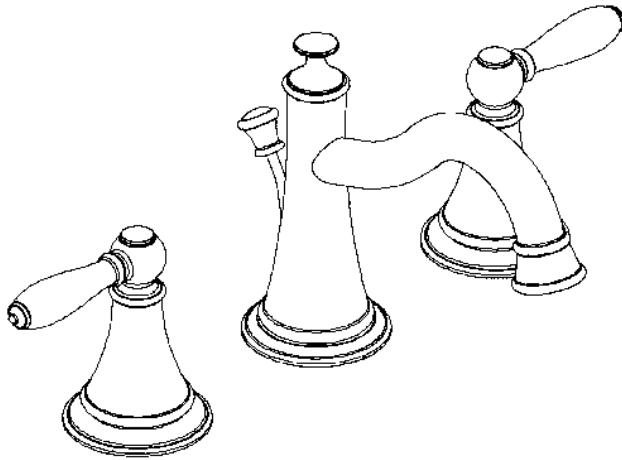

FEATURES:

- Lead-free brass construction
- ¼ turn ceramic cartridge
- 1.5 gpm flow rate
- Traditional style
- Includes drain assembly
- Quick connect fittings

COMPLIANCE:

- Certified to ASME A112.18.1/CSA B125.1, NSF61 and WaterSense standards
- CA AB 1953 certified



AVAILABLE FINISHES:

ADD SUFFIX TO MODEL #

- Polished Chrome (standard)
- Brushed Nickel -BN

WARRANTY:

- 1 year limited

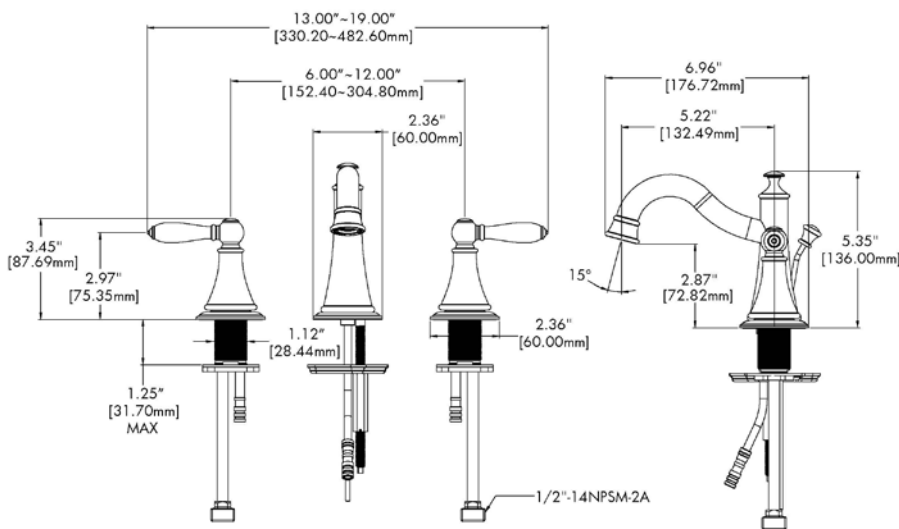

NOTE: 1. All dimensions are in inches (millimeters) unless otherwise specified and are subject to change without notice.

THIS SPACE FOR ARCHITECT/ENGINEER APPROVAL.

SPEAKMAN®

400 ANCHOR MILL ROAD | NEW CASTLE, DE 19720
P: 800-537-2107 | F: 800-977-2747
WWW.SPEAKMANCOMPANY.COM

REVISION DATE: FEB. 2013

Management Systems
Registered to ISO 9001