

LEXIA

THERMOSTATIC TRIM
 REGULADOR TERMOSTÁTICO
 GARNITURE THERMOSTATIQUE
 SKU: 953782

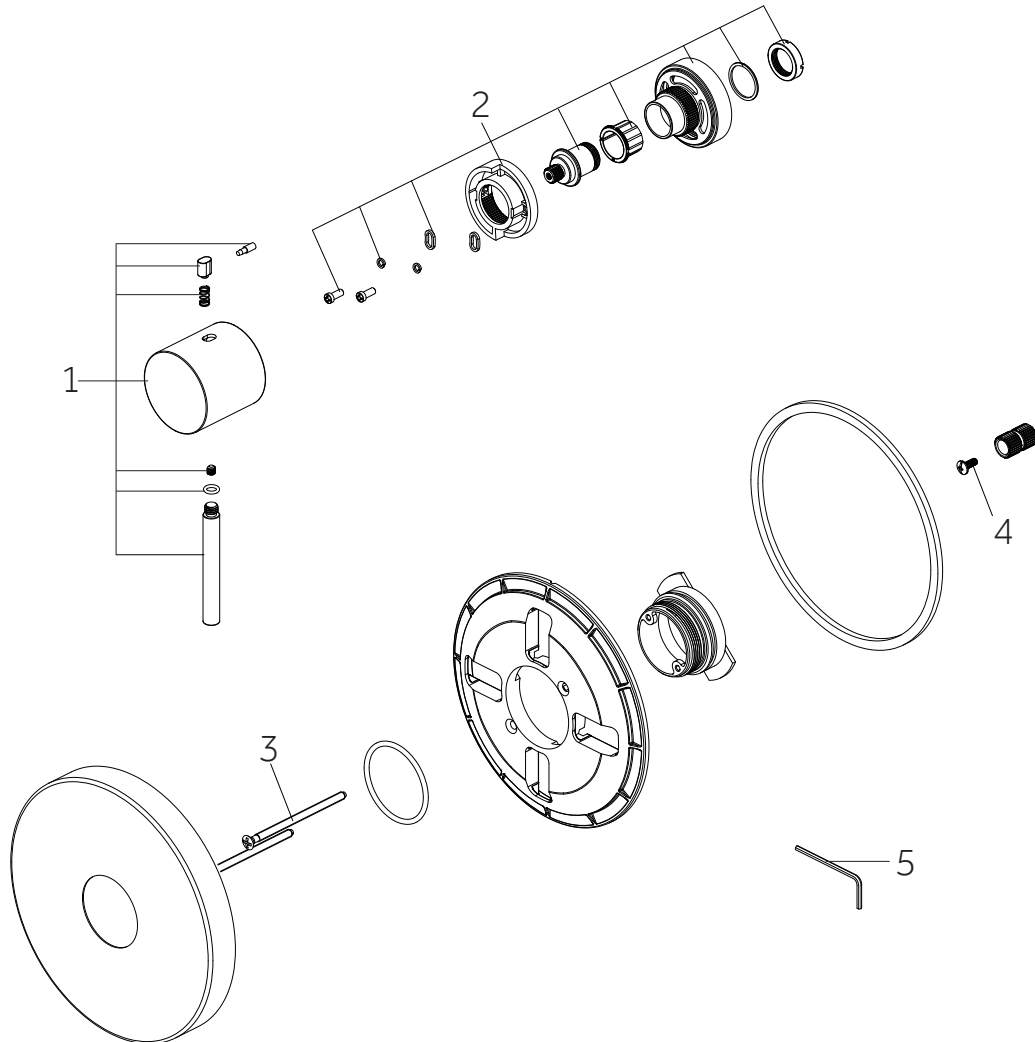

No.	Part Name / Nombre de pieza / Pièce	Part No.
1	Handle Assembly / Ensamblaje de la Manija / Manette	OBPF713069*
2	Handle Seat Assembly / Montaje del asiento del mango / Assemblage du siège de la poignée	OBPF713070*
3	Screw / Tornillo / Vis	OBPF50026CP
4	Screw / Tornillo / Vis	OBPF150142
5	2.5mm Hex Allen Wrench / 2.5mm Hex Llave Allen / 2.5mm Hex Cié hexagonale	OBPF1RP70221

*Specify Finish / Especifica el Acabado / Spécifiez la Finition

Code: SHLE9009

THE RMOSTATIC ROUGH-IN SHOWER VALVE

VÁLVULA DE DUCHA TERMOSTÁTICA OCULTA

ROBINET DE DOUCHE BRUT THERMOSTATIQUE

SKU: 953782

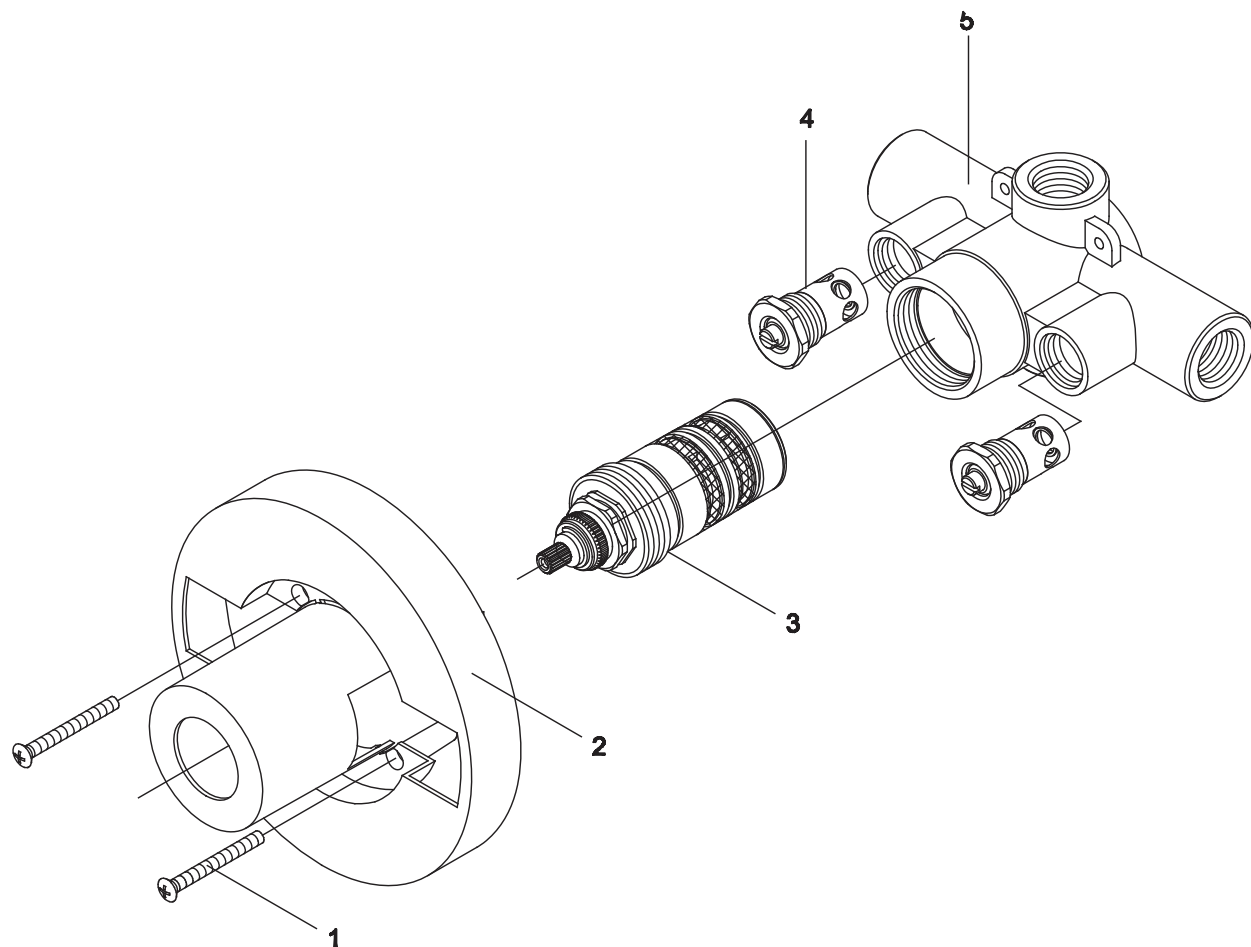

No.	Part title	Material	Q'ty
1	Screw	Brass	2
2	Cover	Plastic	1
3	MIR6004CRT 1/2" cartridge MIR6006CRT 3/4" cartridge	Brass	1
4	Check valve & stops	Brass	2
5	Body	Bronze	1

LEXIA

IN-WALL SHOWER DIVERTER TRIM
DESVIADOR DE DUCHA DE PARED
GARNITURE D'INVERSEUR DE DOUCHE INTÉGRÉE
SKU: 953782

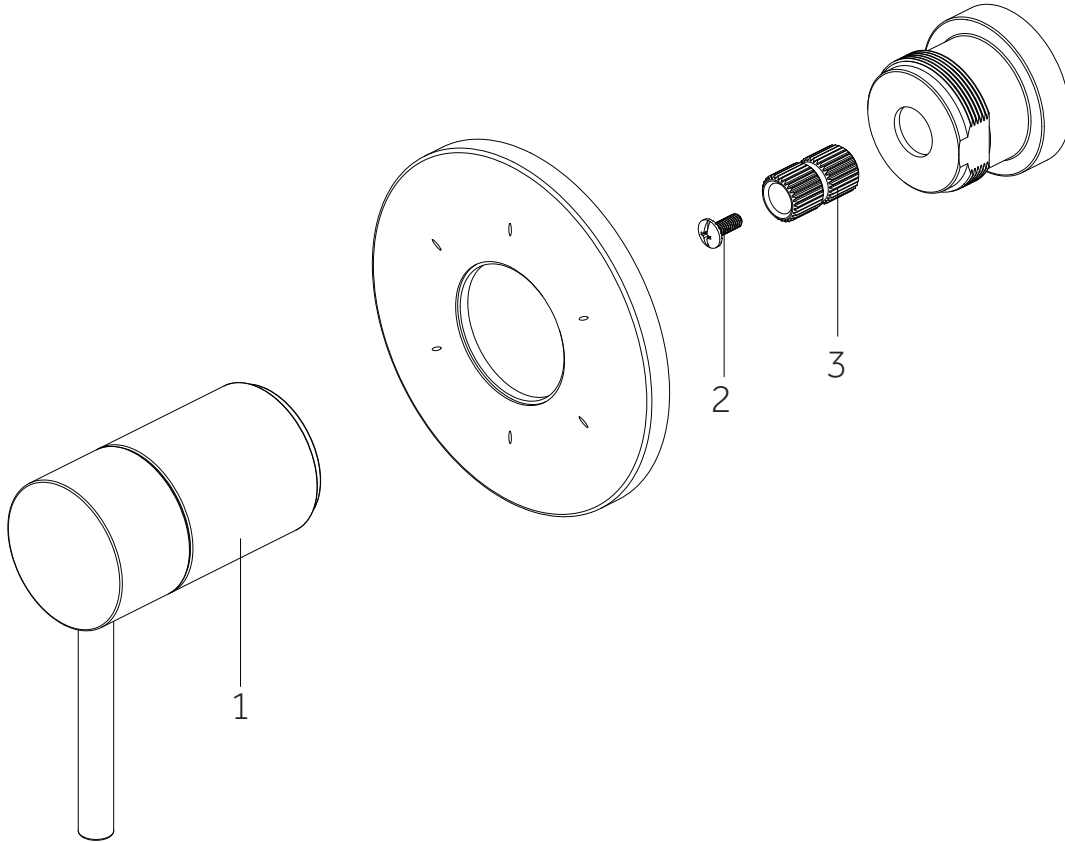

No.	Part Name / Nombre de pieza / Pièce	Part No.
1	Handle Assembly / Ensamblaje de la Manija / Manette	OBPF713071*
2	Screw / Tornillo / Vis	OBPF150142
3	Connector / Conector / Raccorder	OBPF870350

*Specify Finish / Especifica el Acabado / Spécifiez la Finition

Code: SHLE9005

DIVERTER ROUGH-IN VALVE

VÁLVULA DESVIADORA OCULTA

VALVE BRUTE D'INVERSEUR

SKU: 953782

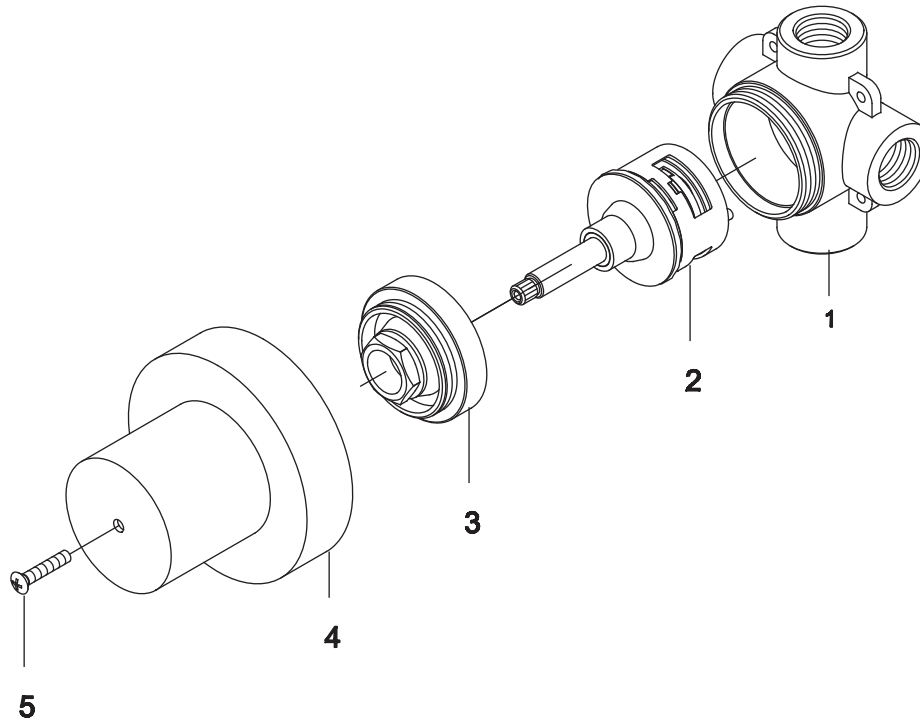

No.	Part Name	Nombre de pieza	Nom de la pièce
1	Body	Cuerpo	Corps
2	6 way cartridge: MIR6180 CALGreen cartridge (no shared positions): MIR6150	Cartucho de 6 vías: MIR6180 Cartucho CALGreen (sin posiciones compartidas): MIR6150	Cartouche 6 voies: MIR6180 Cartouche CALGreen (pas de positions partagées): MIR6150
3	Hub	Cubo	Centre
4	Cover	Cubrir	Couverture
5	Screw	Tornillo	Vis

Code: SH6103

LEXIA

IN-WALL SHOWER VOLUME CONTROL TRIM
VÁLVULA OCULTA DE CONTROL DE VOLUMEN
GARNITURE DE CONTRÔLE DU VOLUME DE LA DOUCHE À MONTAGE MURAL
SKU: 953782

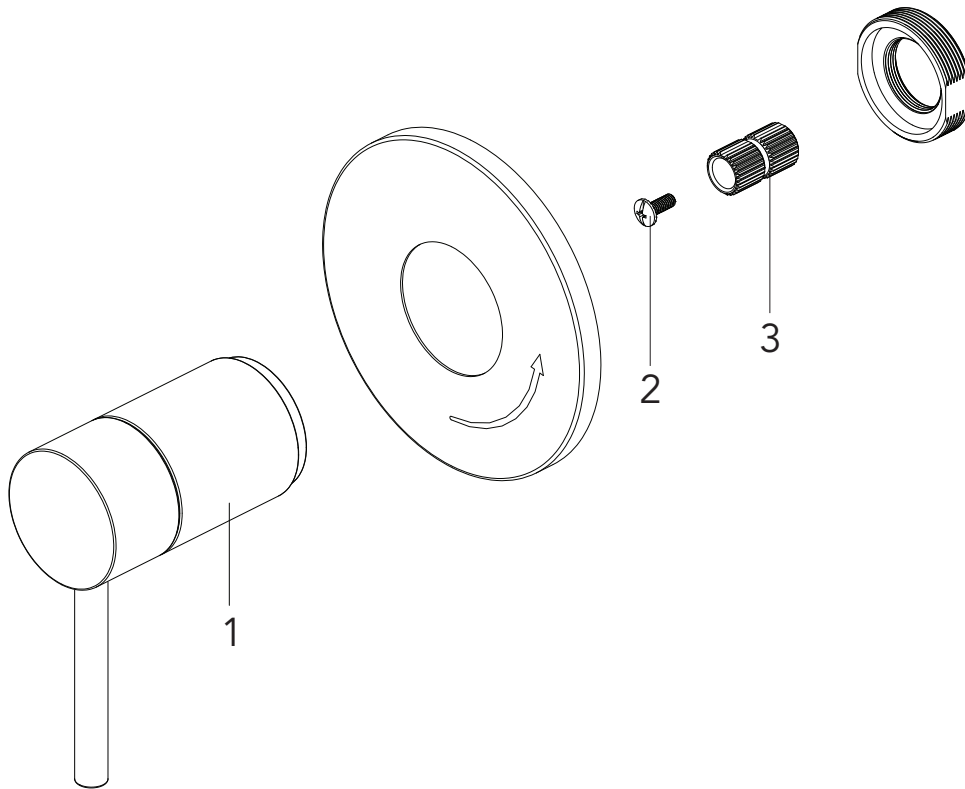

No.	Part Name / Nombre de pieza / Pièce	Part No.
1	Handle Assembly / Ensamblaje de la Manija / Manette	OBPF713071*
2	Screw / Tornillo / Vis	OBPF150142
3	Connector / Conector / Raccorder	OBPF870350

*Specify Finish / Especifica el Acabado / Spécifiez la Finition

Code: SHLE9007

VOLUME CONTROL ROUGH-IN VALVE

1/2" AND 3/4" CONNECTION

CONEXIÓN DE 1/2 Y 3/4" PULGADA DE VÁLVULA OCULTA DE CONTROL DE VOLUMEN

CONTRÔLE DU VOLUME BRUT RACCORD 1/2" ET 3/4"

SKU: 953782

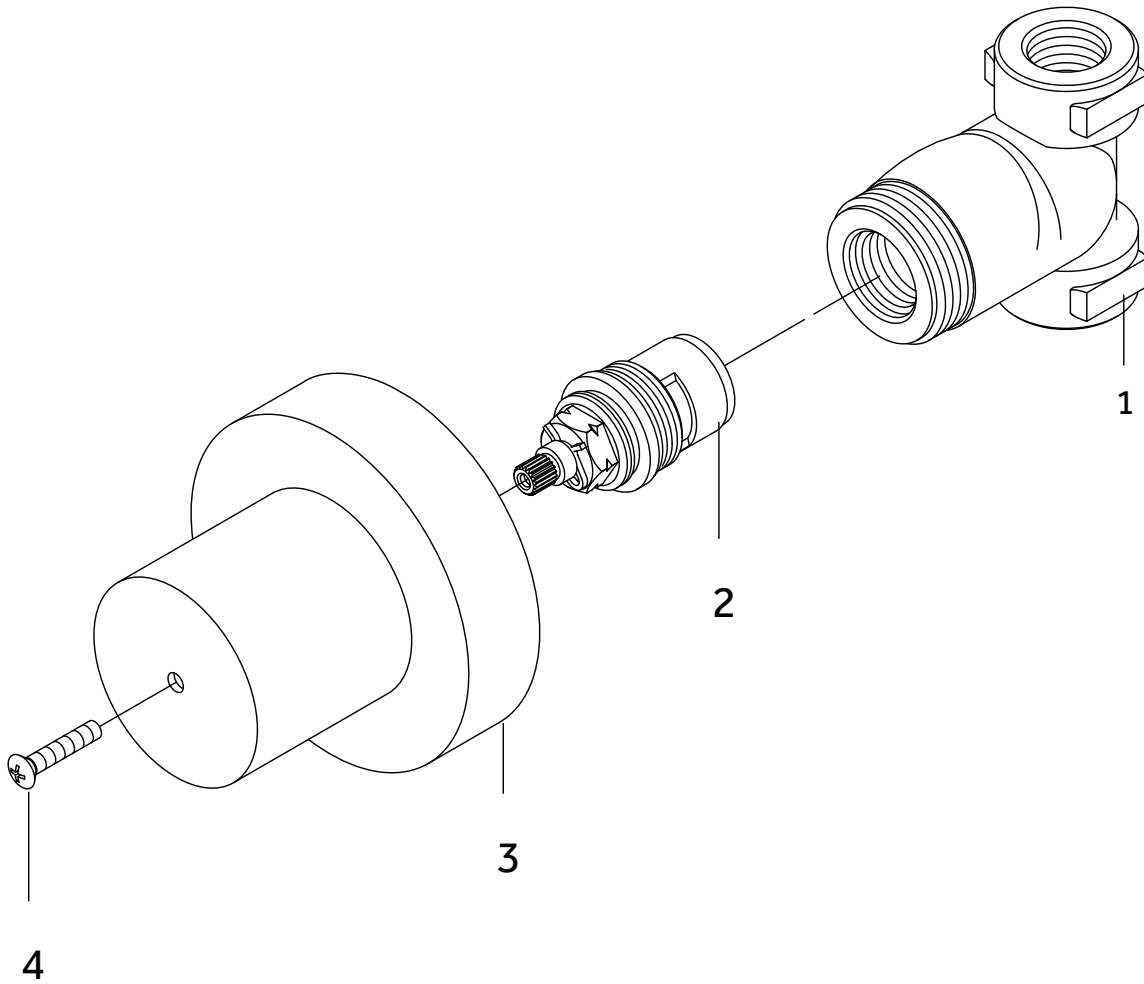

No.	Part title	Material	Q'ty
1	Body	Bronze	1
2	MIR6020CRT 1/2" cartridge MIR6040CRT 3/4" cartridge	Brass,ceramic	1
3	Cover	Plastic	1
4	Screw	Brass	1