

Trim Diagram  
Refrax™ Pendant RE2506A

Important: Label on back contains important information on your crystal option. Please save in case you ever need to order matching crystal.

SCHONBEK®



Swarovski Lighting, LTD., 61 Industrial Blvd., Plattsburgh NY 12901-1908  
Tel: 800.836.1892 or 518.563.7500 www.schonbek.com

©2015 SWAROVSKI LIGHTING, LTD.



SCHONBEK®

Trim Diagram  
Refrax™ Pendant RE2506A

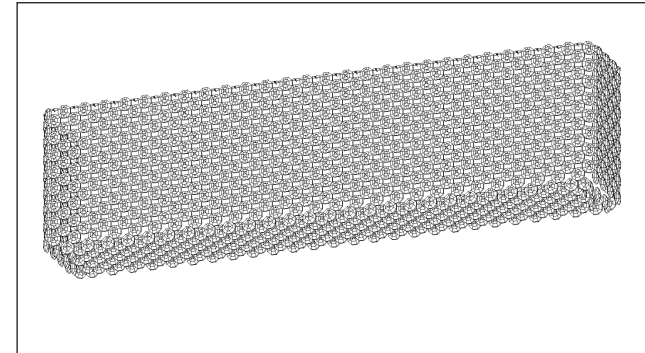

7 Lights  
Length: 25", Width: 4", Height: 6½"

This design is the proprietary trade dress/trademark of Swarovski Lighting, LTD.

Please save your trim diagram for future reference.

IMPORTANT: Label on back contains important information on your crystal option. Please save in case you ever need to order matching crystal.

SCHONBEK® is a member of the Swarovski group.

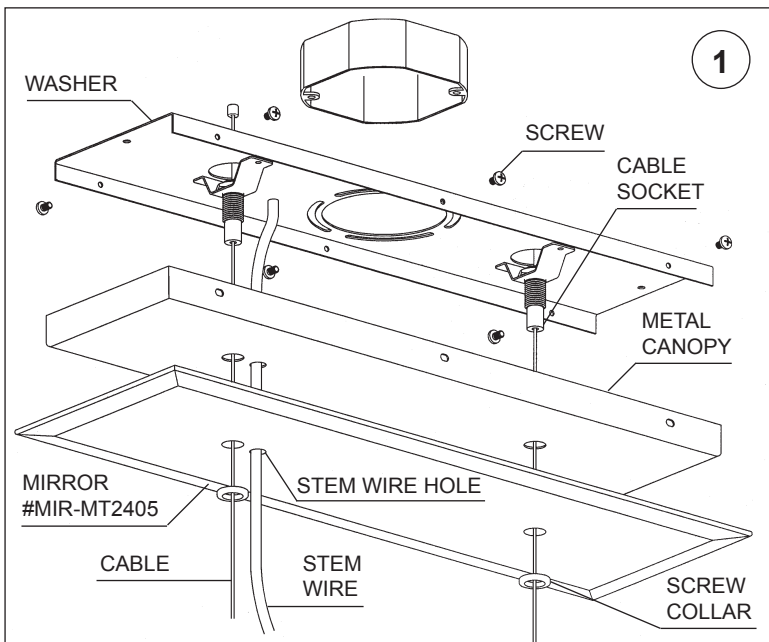

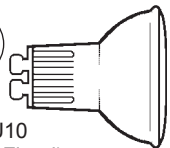
**2**  4 - GU10 (Wide Flood) (supplied - Schonbek # : EXN/GU10) 50 Watts Max.

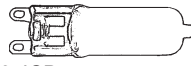
 3 - G9 JCD 25 Watts Recommended (Supplied - Schonbek #: JCD-G9-25) 40 Watts Max Hanging Weight: 15 pounds

 To avoid damaging, do NOT touch bulb with bare hands. Install bulb with clean cloth or tissue.

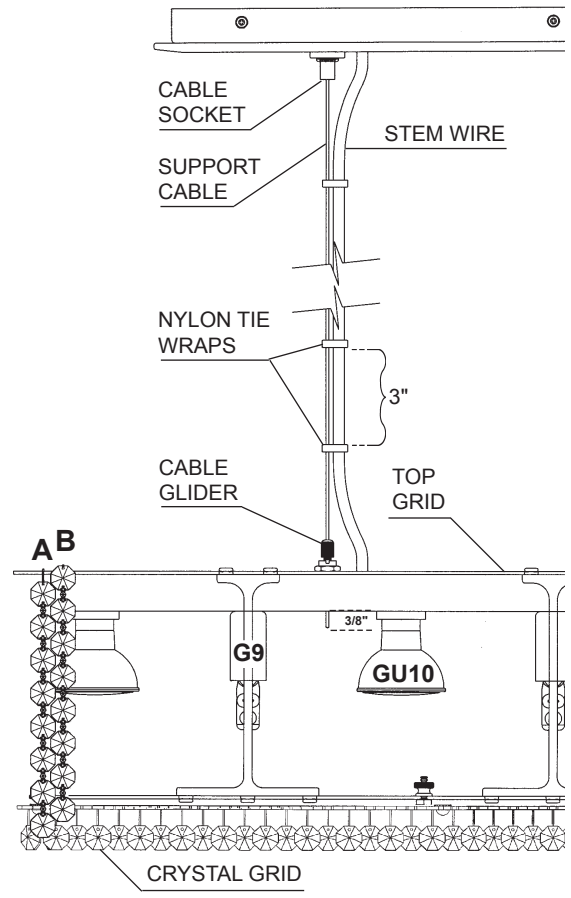
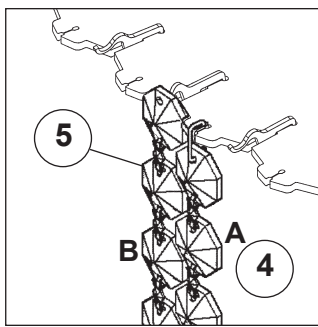

**How to Install G9 & GU10 Bulbs and Refrax™ Chandelier:**

**1** Remove the screw collar, mirror, metal canopy from the canopy assembly and attach crossbar using hardware (not provided) to outlet box. Feed suspension cable through running thread from the top so that the cast cable end is seated in the inside of the cable socket. Attach crossbar to the ceiling with cable hanging down. Feed suspension cable through the center hole (larger hole) of the canopy, mirror and then screw collar. The metal canopy must be finish side down and on top of the mirror with beveled side down. Loosen the safety nut by turning it counter clockwise and depress it in order to feed the cable into cable glider on chandelier frame and hang to desired height. Slide cable into glider and allow it to play out of the bottom of the frame temporarily. To adjust height, hold the frame with one hand while depressing the safety nut with the other hand until the cable is released. Feed stem wire through stem wire hole in mirror and metal canopy (the smaller hole). When chandelier is at desired height, trim stem wire and connect ground wire (marked with green tracer) and power wires (black or white tracers) in outlet box. Raise metal canopy and mirror to ceiling and secure to running thread with the screw collar. Supplied are 4 cable grips. Clip to support cable and adjust along stem wire as desired. Suspension cable will exit the side of chrome spike. Cut excess cable off with cable cutters.

**2** Use G9 JCD bulbs in the small sockets. Plug bulbs carefully but completely into sockets. Use only GU10 base bulb in the larger sockets. Align the legs, insert and turn clockwise carefully but completely. Only use bulbs marked "suitable for open luminaires" OR bearing this symbol: 

**3** Install bottom crystal grids with eight thumb nuts (already screwed onto grid) to bottom of the chandelier. .

**4** Hang A chains first, following the Crystal Map. Insert metal connector into the hole in the top grid and let chain hang freely.

**5** Slip Chain B over the pin and let hang freely.

**DETAIL: How to Orient Crystal Grid Perfectly**

