

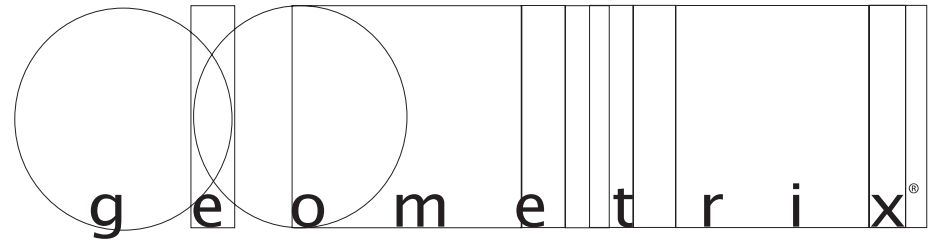

Schonbek Worldwide Lighting Inc., 61 Industrial Blvd., Plattsburgh NY 12901-1908
Tel: 800.836.1892 or 518.563.7500 www.schonbek.com or www.geometrix-lighting.com
For cleaning instructions, visit www.schonbek.com or www.geometrix-lighting.com

© 2008 SCHONBEK WORLDWIDE LIGHTING INC., A. SCHONBEK & CO. LTD. WORLDWIDE COPYRIGHT RESERVED
US UTILITY PATENT PENDING



Trim Diagram
Pendant DIC1206**

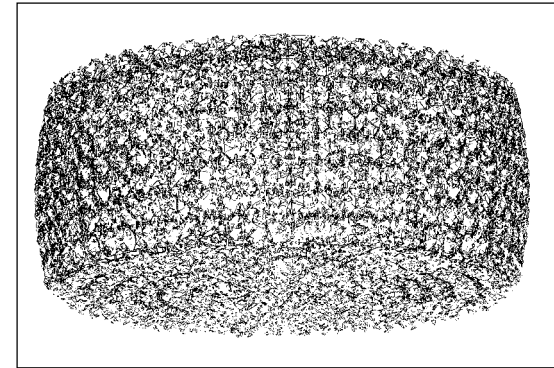

2 Lights
Diameter: 11-1/2"
Height: 6"

Geometrix™ is designed by Schonbek with Strass® crystal by Swarovski.



This design is the proprietary trade dress/trademark of Schonbek Worldwide Lighting Inc

Please save your trim diagram for future reference.

IMPORTANT: Label on back contains important information on your crystal color. Please save in case you ever need to order matching crystal.



Instructions for electrician STEPS 1 - 4

All electrical components must be installed by a licensed electrician in accordance with the National Electric Code and the appropriate local electrical codes.

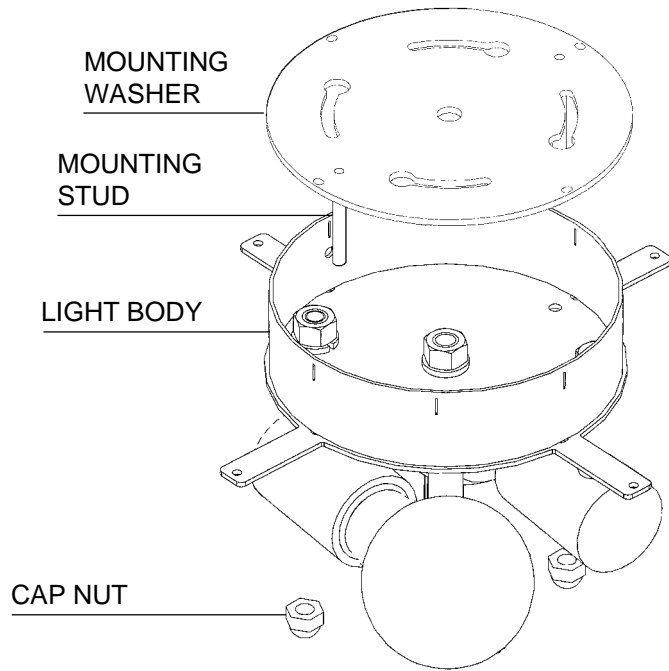

- 1** Make sure power to the outlet box is disconnected. Feed fixture wires through center hole in mounting washer. Connect ground wires and power wires (black or white tracers) in outlet box.
- 2** Attach mounting washer to outlet box (screws not provided).
- 3** Carefully slide light body over mounting studs and secure in place with cap nuts.
- 4** Screw bulbs into sockets and make sure to test before trimming.

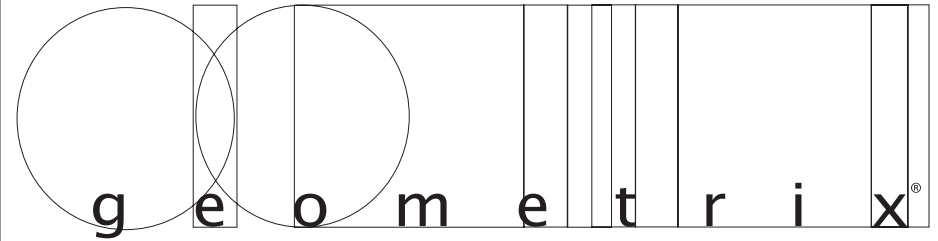

Frequency of cleaning crystal

We know people who clean their crystal every few months, because they love handling the crystals and admiring them close up. Others do a cleaning every six or nine months.

To stretch the time between cleanings, dust lightly every two or three months with a feather duster, lambswool duster or make-up brush.

Frequency of cleaning depends on location of your Dionyx and other environmental factors.

Crystal needs cleaning when it appears dusty or dull. Just look at your Dionyx frequently (always enjoyable), and you'll know when it's time for a cleaning.

REPLACING CRYSTAL OCTAGON:

If a crystal octagon breaks, you'll see a bare spot in the framework.

A Turn both tabs 90° counterclockwise on either side of pocket where the octagon should be.

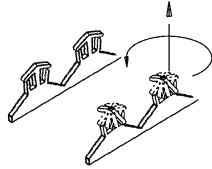

B Slide crystal octagon into pocket. Turn both tabs clockwise back to original position to hold the octagon in place.

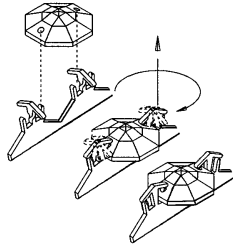

REPLACING CRYSTAL BEAD:

If a crystal bead breaks, you'll see a bare spot in the framework.

A Use needle nose pliers and pull the empty "L" bracket straight out.



B Slide crystal bead onto the bracket. Use your thumb and push the bead and bracket back into place.

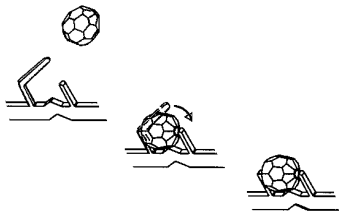

NOTES:

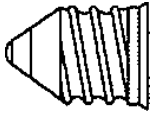

2 - A19, BT15, or JDD Bulbs
(Halogen Bulbs Recommended)
75 Watts Max
Hanging Weight: 6lbs.

Install bulbs and be sure to test
fixture BEFORE assembly.

How to Assemble Your Dionyx Close to Ceiling:

- Remove the (4) screws from the (4) mounting tabs. Carefully screw crystal basket onto (4) mounting tabs. Make sure to tighten each screw completely.
- Attach bottom crystal grid by sliding mounting balls into large holes on the bottom of the crystal basket. Turn bottom crystal grid counter-clockwise until mounting balls are securely placed in smaller holes on crystal basket.

LIGHT BODY

MOUNTING TAB

CRYSTAL BASKET

SCREW

MOUNTING BALL

BOTTOM CRYSTAL
GRID

