

PETIT CRYSTAL DELUXE 5902- __ __A

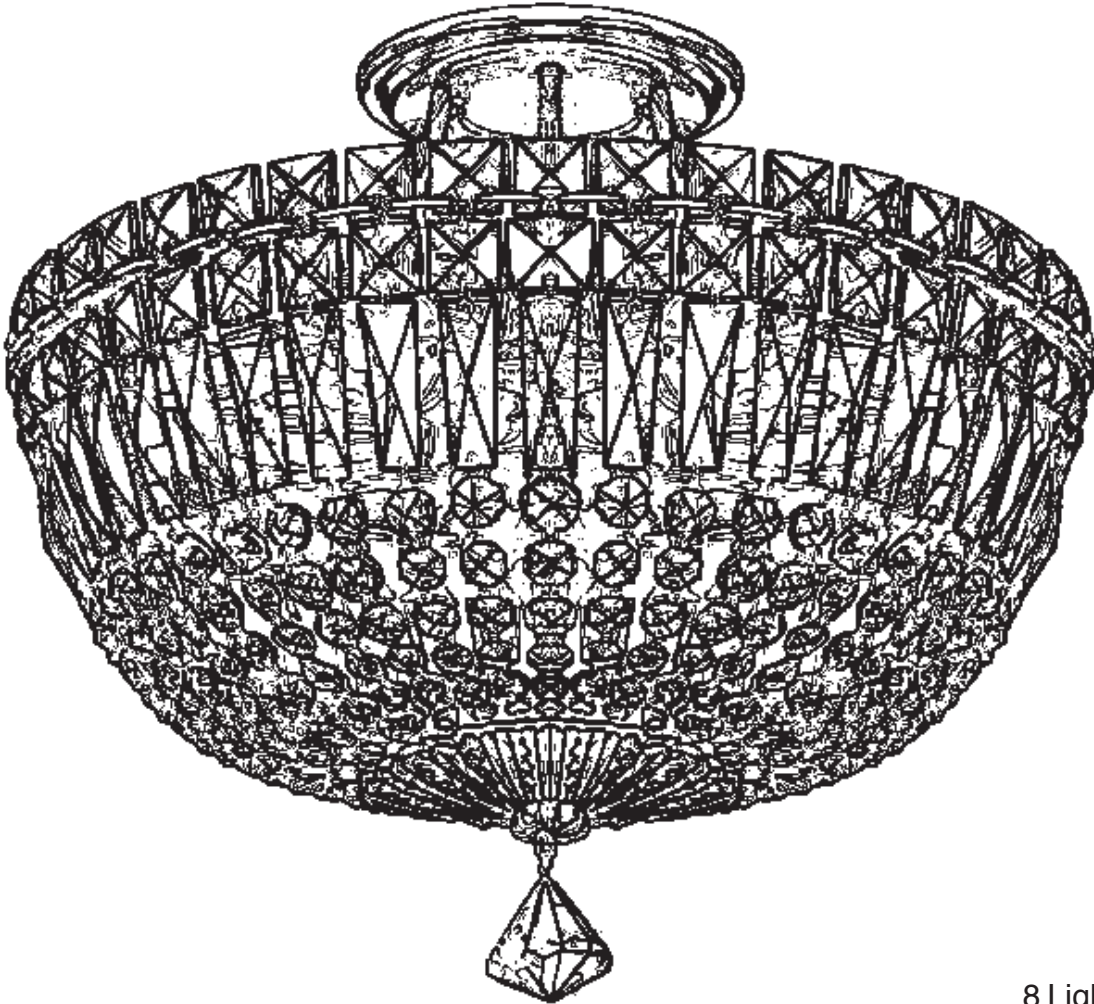

8 Lights
Diameter: 14"
Body Length: 13"
Hanging Weight: 6 lbs.

THIS DESIGN IS THE PROPRIETARY
TRADE DRESS/TRADemark OF
SWAROVSKI LIGHTING, LTD.



SCHONBEK®



SCHONBEK®

MAX 40 W		110-120 V						

SCHONBEK® is a member of the Swarovski group.

All electrical components must be installed by a licensed electrician in accordance with the National Electric Code and the appropriate local electrical codes.

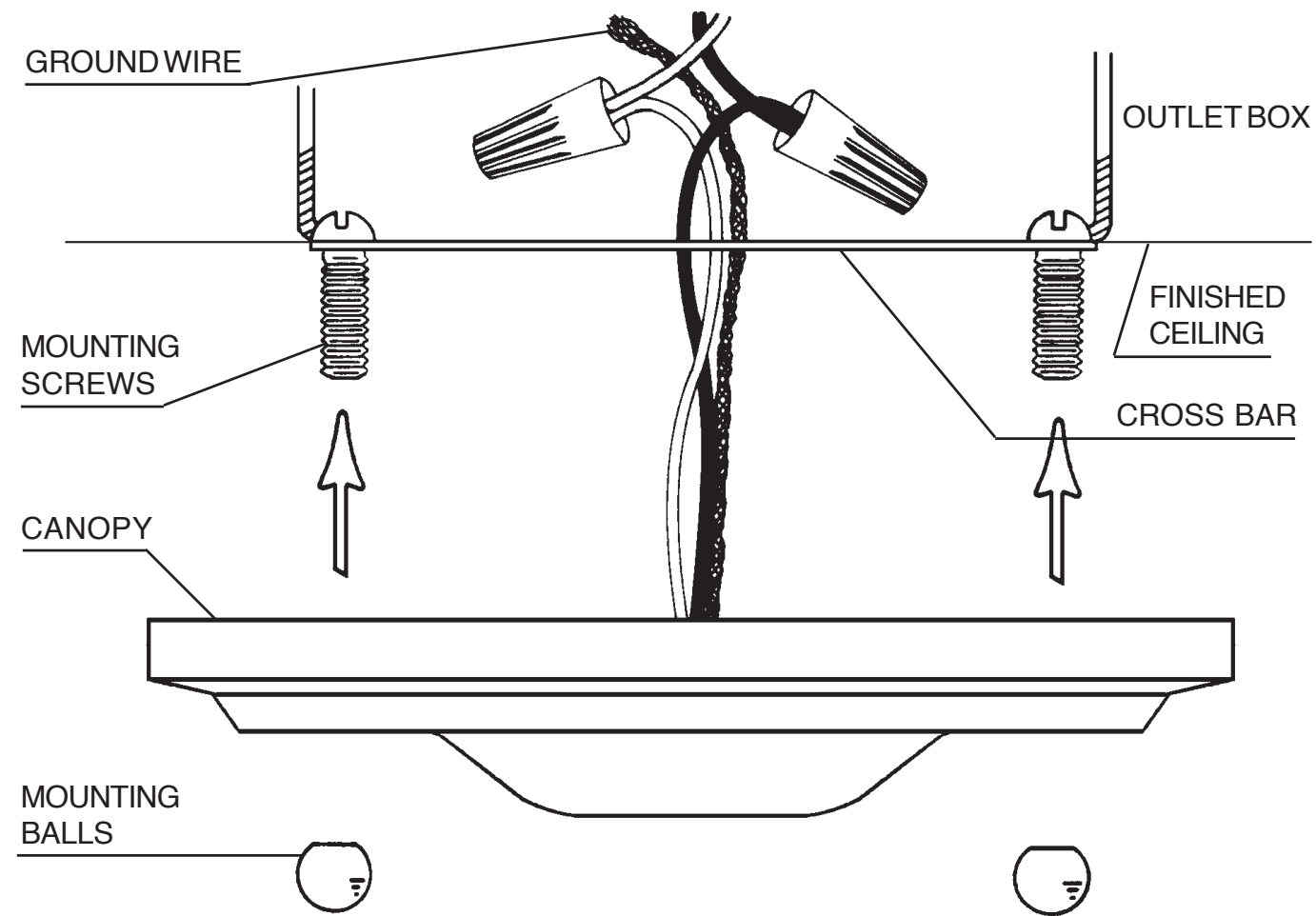

- 1** Attach cross bar to outlet box.
- 2** Again, make sure that power to the outlet box is disconnected. Feed stem wires through cross bar and attach to power wires in outlet box. Fixture **MUST** be properly grounded.
- 3** Attach canopy to ceiling with mounting balls, thereby retaining complete fixture against ceiling.
- 4** Screw bulbs into sockets. Test power to insure proper wiring before hanging trim from fixture.

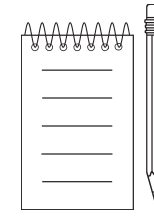



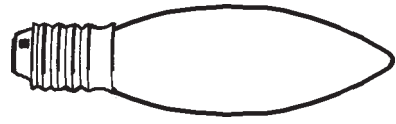

You will need 4 - B10
25 Watts Recommended
40 Watts Max

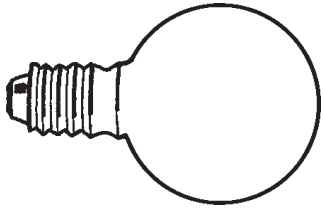

You will need 4 - G16-1/2
25 Watts Recommended
40 Watts Max
MIN 90°C SUPPLY
CONDUCTORS

5

Install bulbs and be sure
to test fixture **BEFORE**
trimming.

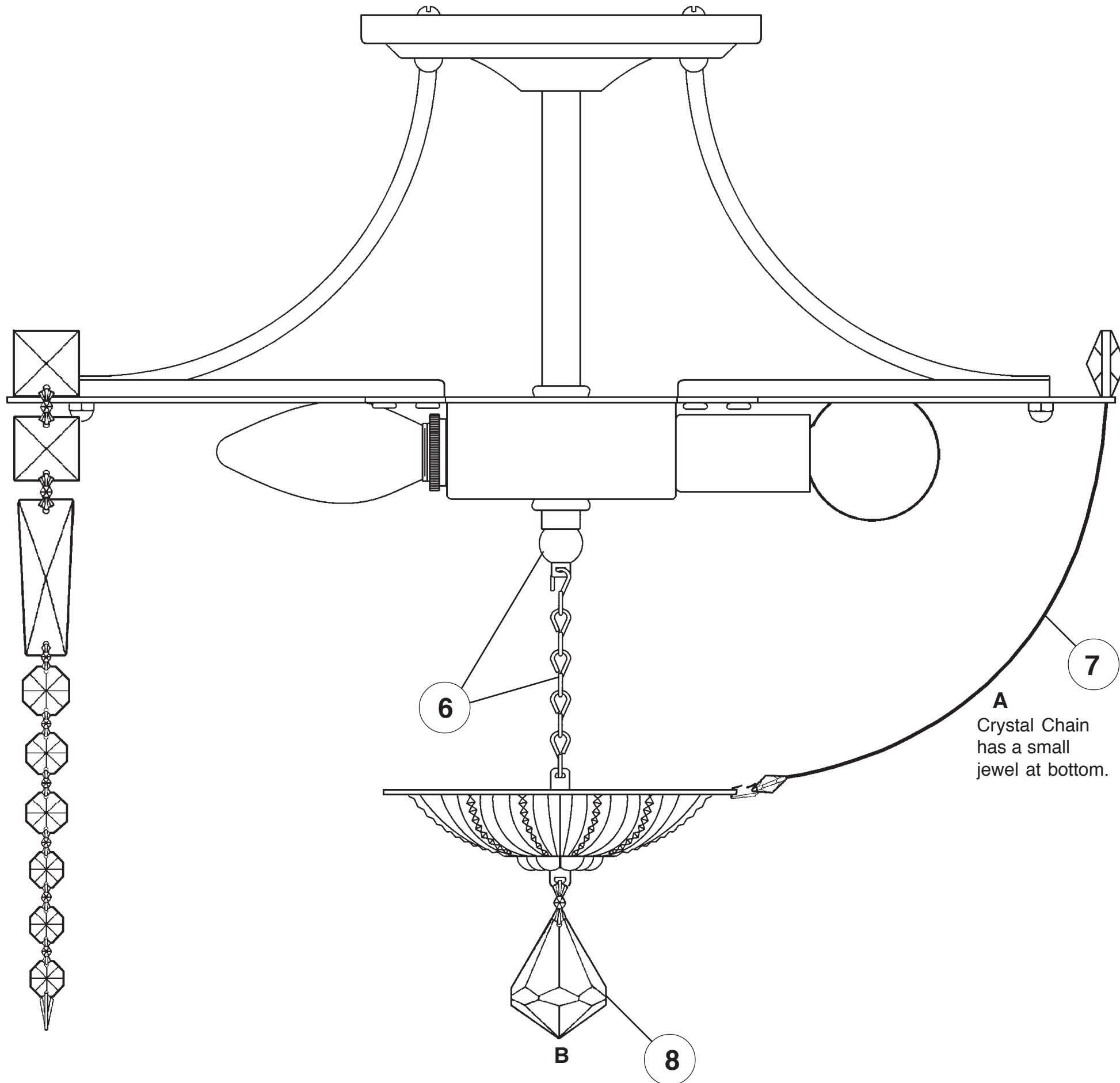

Installation of Crystals "A"

Hold onto small square
stone end and turn chain
side ways, this will allow
connector (connector
opening faces to the
back) to pass through slot
in ring. (See diagram
below)

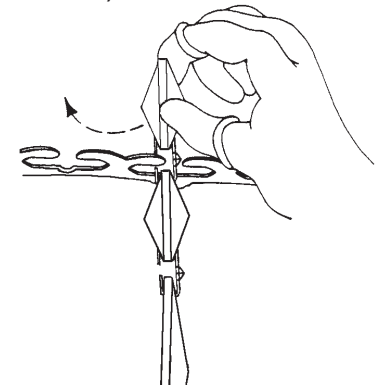

Turn square stone to face
the outside of the fixture
and lower it until it seats
itself in the ring.
(See diagram below)
**NOTE: FLAT SIDE FACES
INSIDE FIXTURE!**

