

SCHONBEK®

SCHONBEK IS A WORLD LEADER IN CHANDELIER
DESIGN. PATENTS INCLUDE:
#5,144,541, #5,222,805 & #5,460,269

EQUINOXE 2733-_____ (Finish Option) TRIM DIAGRAM

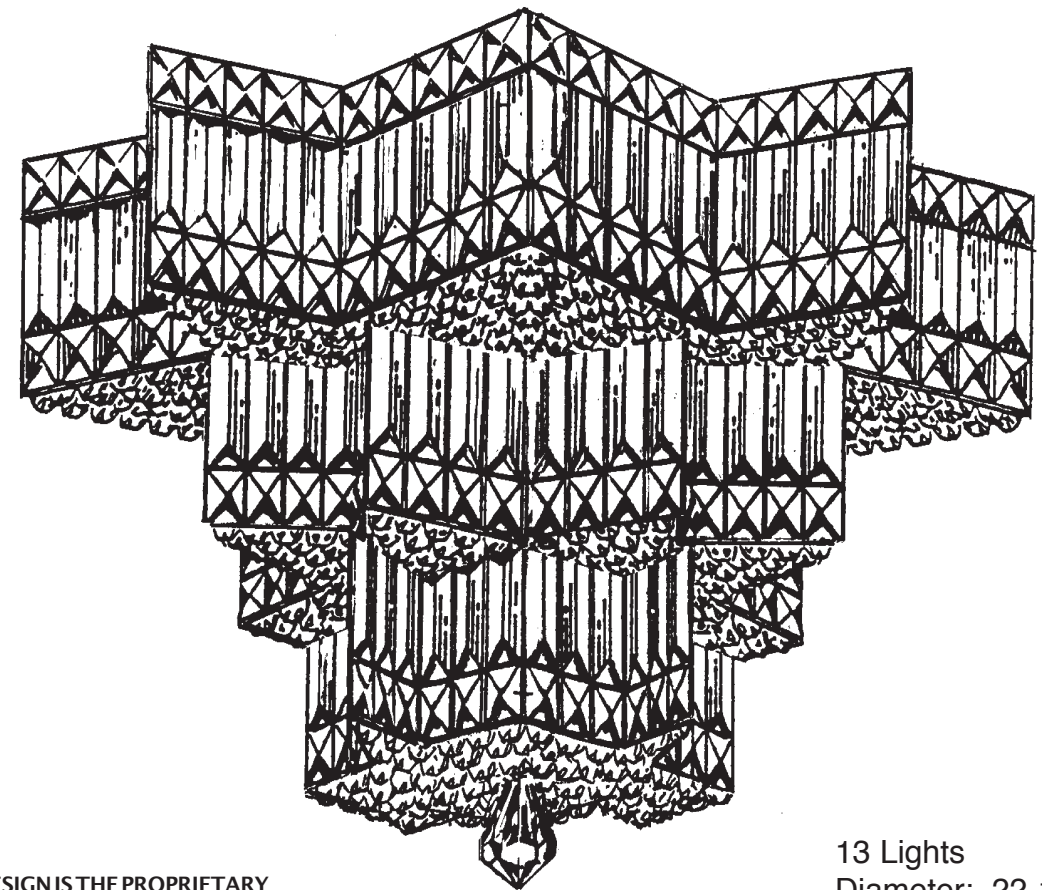

THIS DESIGN IS THE PROPRIETARY
TRADE DRESS/TRADE MARK OF
SCHONBEK WORLDWIDE LIGHTING INC.

13 Lights
Diameter: 22-1/2"
Body Length: 13-1/2"

SCHONBEK®

This fixture was designed and manufactured in Plattsburgh, N.Y. Our high-quality crystal fixtures are made with state-of-the-art manufacturing equipment. If you have any questions about this or any of our more than 450 crystal products, contact your nearest authorized Schonbek distributor.

CAUTION... RISK OF ELECTRICAL SHOCK. Make sure the electrical supply to the chandelier is turned off at the main fuse or circuit breaker before doing any installation. All electrical components must be installed by a licensed electrician in accordance with the National Electric Code and the appropriate local electrical codes.

HANGING WEIGHT: 27 pounds

BULBS: 13 - Candle shaped candelabra base C10 bulbs, recommend 25 watts
for best appearance.

40 - Watts Maximum
MIN 90°C SUPPLY CONDUCTORS

WARNING: This chandelier meets UL/CSA requirements. Any tampering will void UL/CSA certification.

IMPORTANT

Please record the following information for future service.

CODE # _____ Four-digit number on outside of carton.

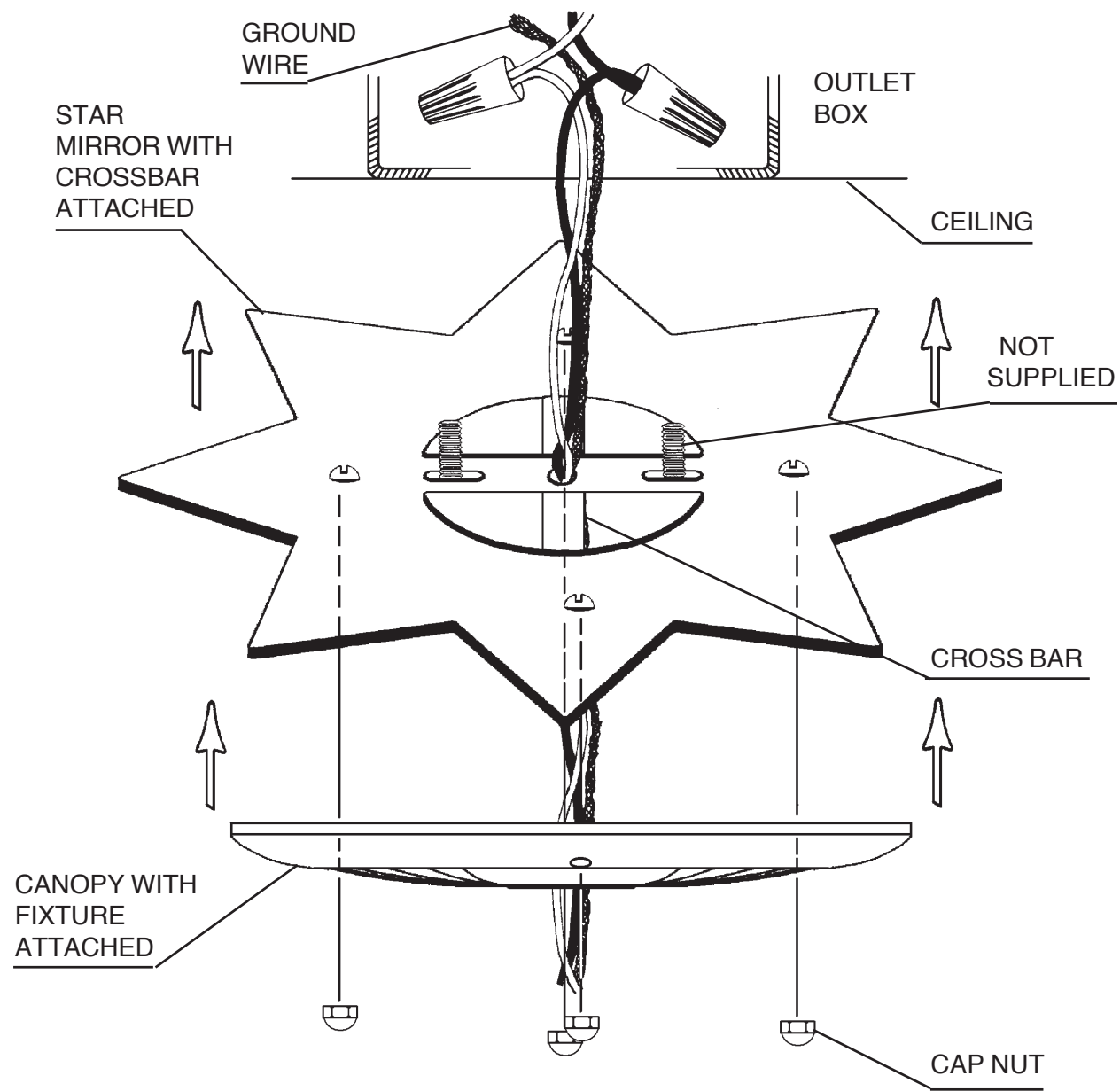

- 1** MAKE SURE POWER IS DISCONNECTED!!
- 2** Insert stem wire through crossbar and star mirror. Connect wires. Fixture MUST be grounded.
- 3** Attach star mirror with crossbar attached to outlet box.
- 4** Check distance from ceiling to assure star mirror assembly will be flush against ceiling. Attach canopy with fixture attached to ceiling with four cap nuts.
- 5** Install bulbs, connect power and test fixture before trimming.

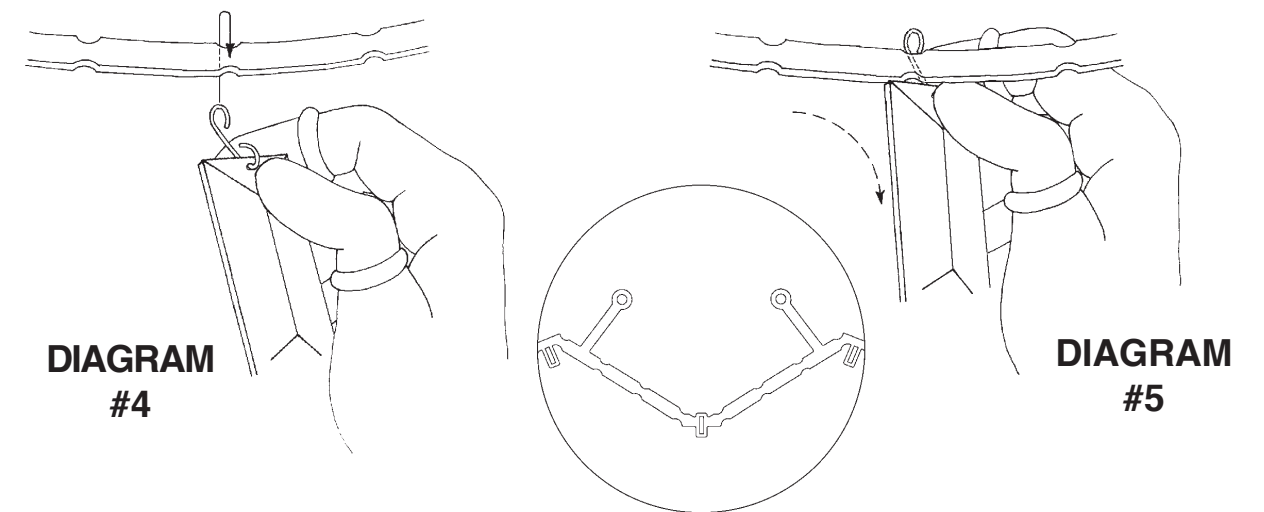

Installation of Crystals "B"

Hook Crystal "B" into the curve of the "scalloped" ring. Hold hook with index finger and thumb. Slide hook from behind scalloped ring. (Diagram #4)

Insert opening of hook onto curve of the ring and slide forward. (Diagram #5)

Allow Crystals "B" to hang in vertical position and to hang freely.
NOTE: FLAT SIDE FACES FRONT!

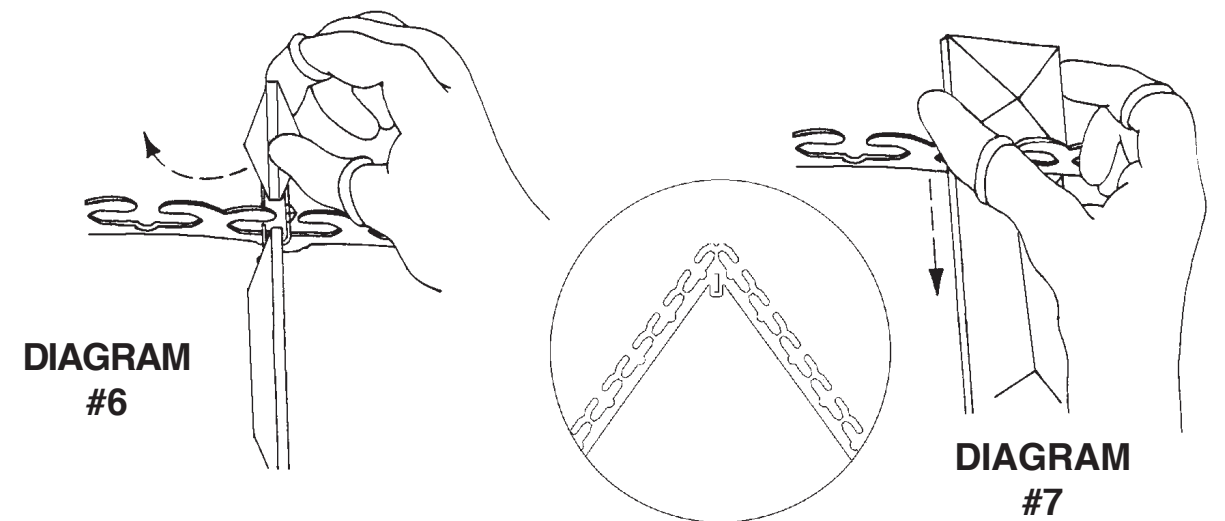

Installation of Crystals "A"

Hold onto small square stone end and turn chain side ways, this will allow connector (connector opening faces to the back) to pass through slot in ring. (Diagram #6)

Turn square stone to face the outside of the fixture and lower it until it seats itself in the ring. (Diagram #7) NOTE: FLAT SIDE FACES FRONT!

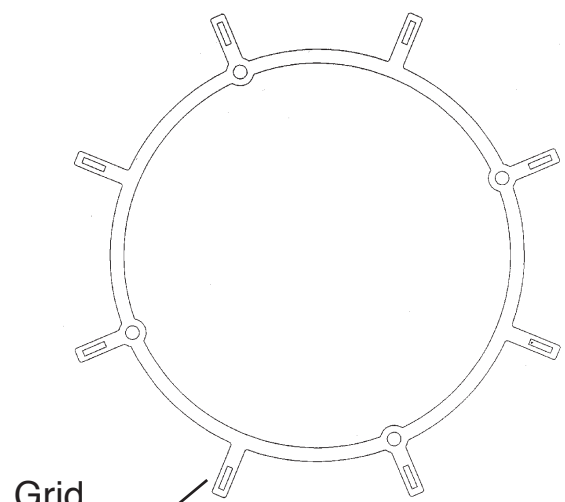

Grid Ring

DIAGRAM #1

Installation of Grid "30199":
 Attach (1) Grid "30199" (with finial attached) with four thumb nuts (already screwed onto grid) to #4 ring. Diagram #1. (See page 5 for location on frame)

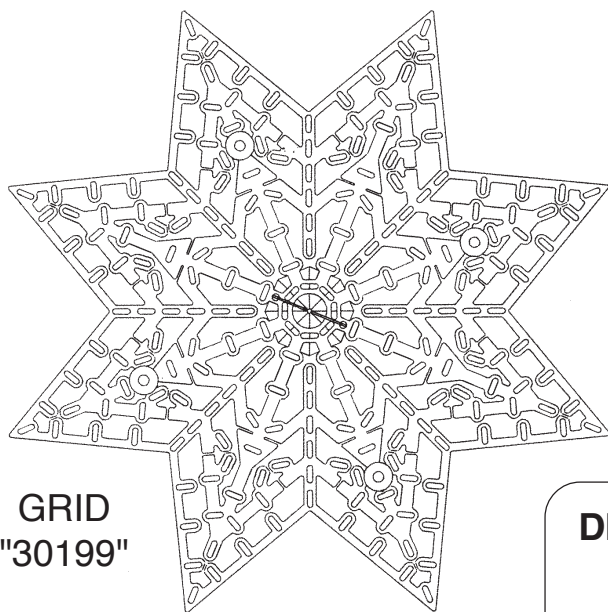

GRID "30193"

Installation of Grid "30193":
 Attach (8) Grids "30193" with two thumb nuts per grid (already screwed onto grid) to #3 ring. Diagram #2. (See page 5 for location on frame)

Installation of Grid "30198":
 Attach (8) Grids "30198" with two thumb nuts per grid (already screwed onto grid) to #2 ring. Diagram #3. (See page 5 for location on frame)

DIAGRAM #3

Grid Spokes

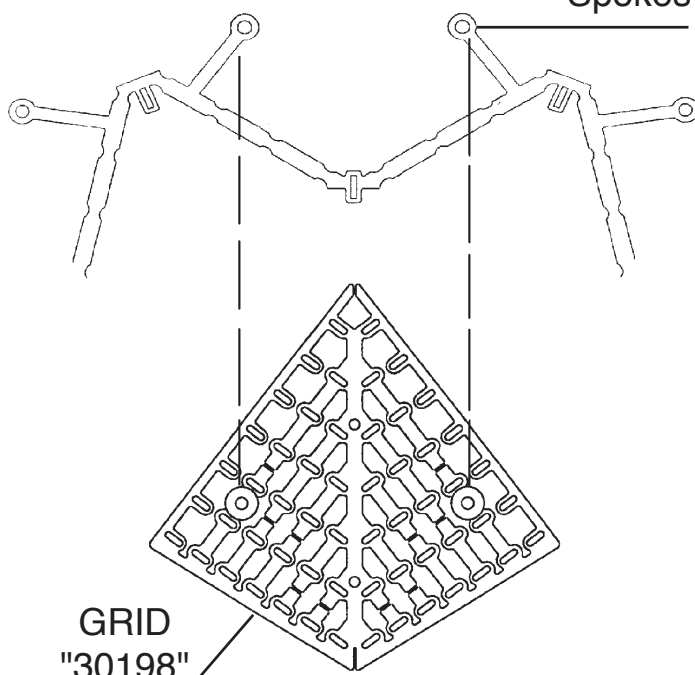

GRID "30198"

DIAGRAM #2

Grid Spokes

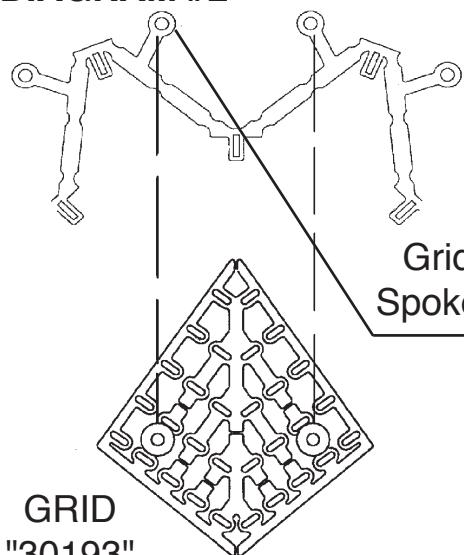

GRID "30193"

TRIM ID SHEET FOR ORDERING SPARE PARTS. PLEASE SAVE FOR CLEANING FIXTURE!

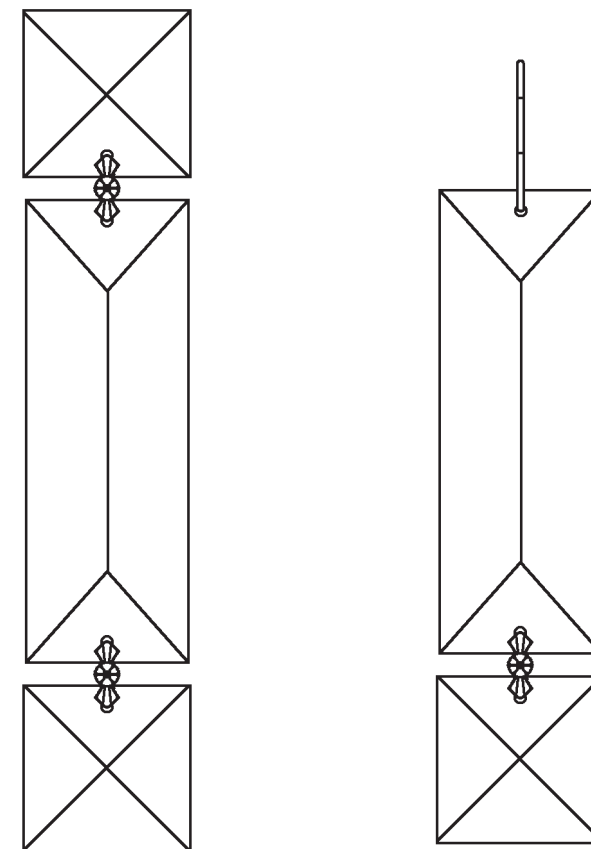

A = N160 (Gold)
 N160S (Silver)

B = N161 (Gold)
 N161S (Silver)

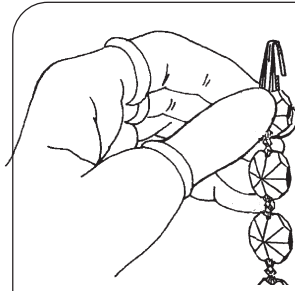

6 Perspiration or oil from fingers will smear the crystals, causing a loss of brilliance. ALWAYS USE FINGER COTS PROVIDED WHEN HANDLING CRYSTALS. Cots should be used on thumb, index and middle fingers of each hand.

**IMPORTANT:
FOLLOW ALL STEPS IN
SEQUENCE**

7 TEST POWER TO INSURE PROPER WIRING BEFORE HANGING TRIM ON FIXTURE. MAKE SURE ALL BULBS ARE IN PLACE.

8 Attach (1) Grid "30199" per instructions on page 6, see diagram #1 for detailed instructions. Hook Chains "B" into scallopes on ring #3, see diagrams #4 & #5 on page 7 for detailed instructions. NOTE: FLAT SIDE FACES FRONT!

9 Attach (8) Grids "30193" per instructions on page 6, see diagram #2 for detailed instructions. Hook Chains "B" into the slots on ring #2, see diagrams #4 & #5 on page 7 for detailed instructions. NOTE: FLAT SIDE FACES FRONT!

10 Attach (8) Grids "30198" per instructions on page 6, see diagram #3 for detailed instructions. Hook Chains "A" into the slots on ring #1, see diagrams #6 & #7 on page 7 for detailed instructions. NOTE: FLAT SIDE FACES FRONT!

