

CHANDELIER 2783-_____
(Finish Option)

TRIM DIAGRAM

SCHONBEK®

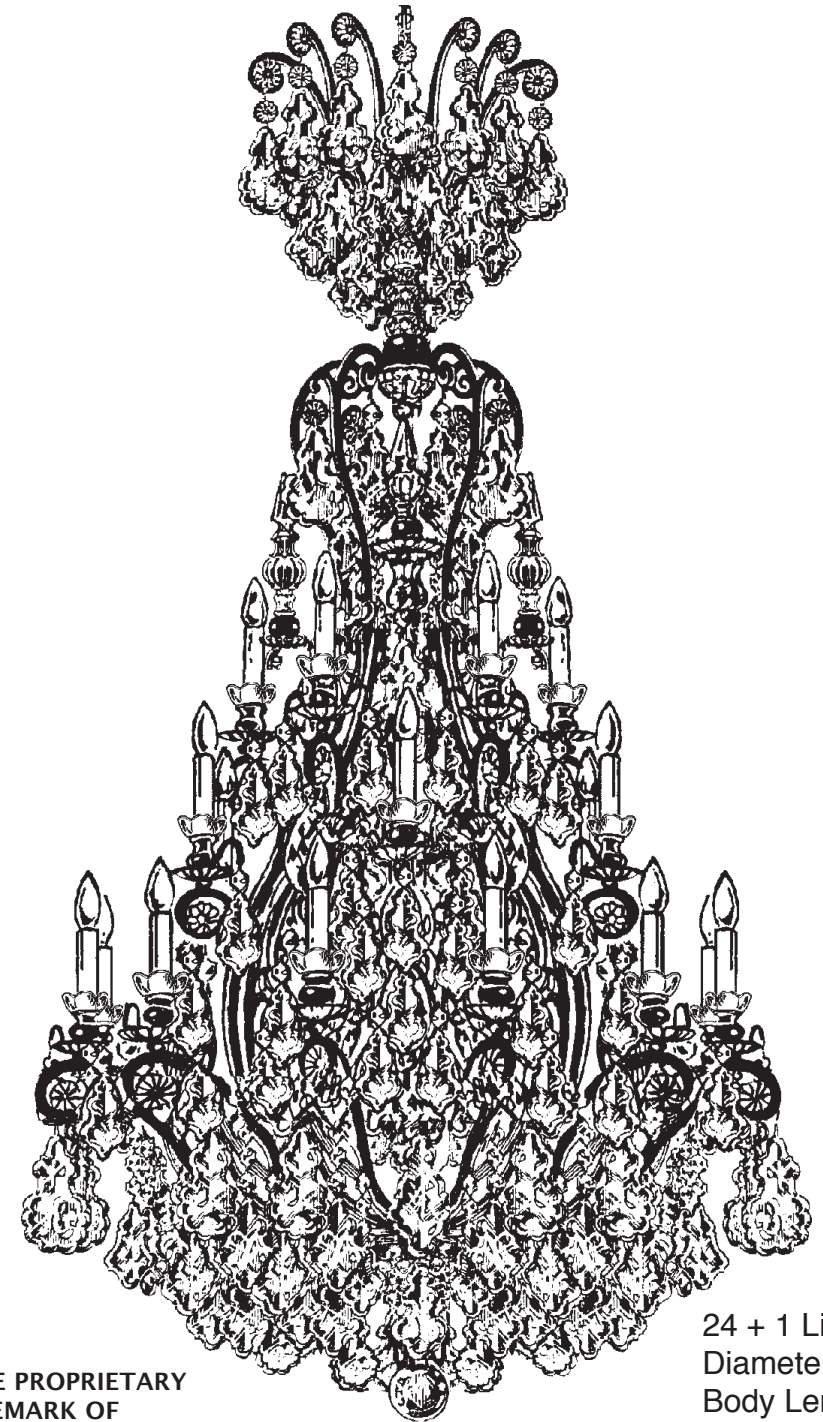

THIS DESIGN IS THE PROPRIETARY
TRADE DRESS/TRADemark OF
SCHONBEK WORLDWIDE LIGHTING
INC.

24 + 1 Lights
Diameter: 36"
Body Length: 72"
Hanging Weight: 92 lbs.

SCHONBEK®

**Follow steps in exact order
Save this trim diagram for future reference**

1

IMPORTANT
*Please record the following
information for future service.*

CODE # _____ Four-digit number on outside of carton.
PACKER # _____ See crystal package label.
ORDER # _____ See crystal package label.

SCHONBEK IS A WORLD LEADER IN CHANDELIER DESIGN. PATENTS INCLUDE:
#D5,222,805 & #D335,362

Instructions for electrician

STEPS 2 - 21

WARNING: THIS LUMINAIRE MUST BE MOUNTED OR SUPPORTED INDEPENDENTLY OF AN OUTLET BOX.

2 **WARNING:**

Electrical Danger Turn Power Off

All electrical components must be installed by a licensed electrician in accordance with the National Electric Code and the appropriate local electrical codes.

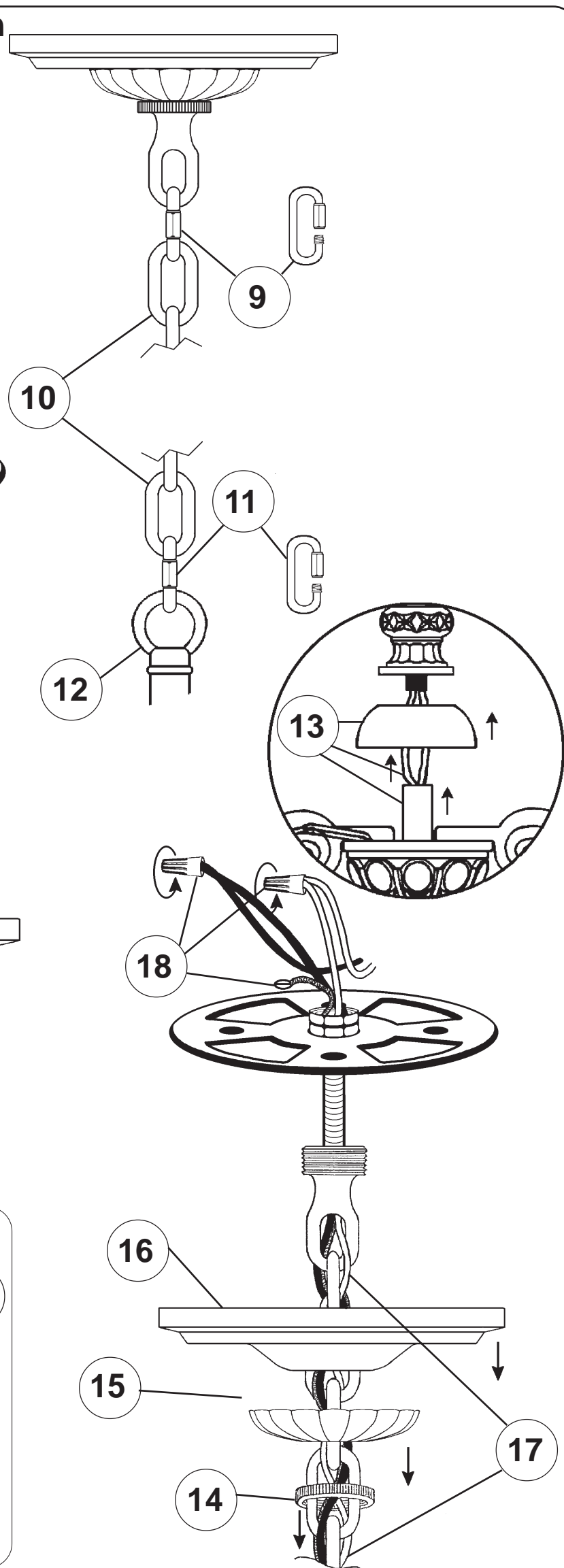
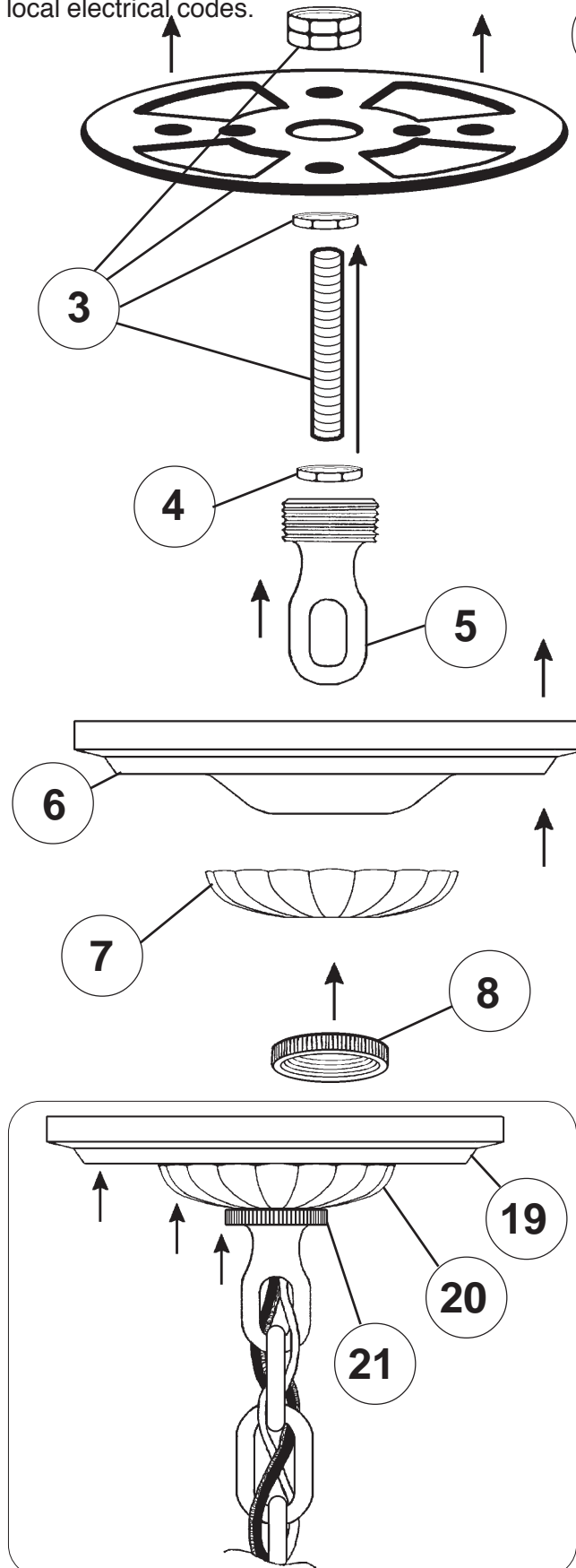

SET #1

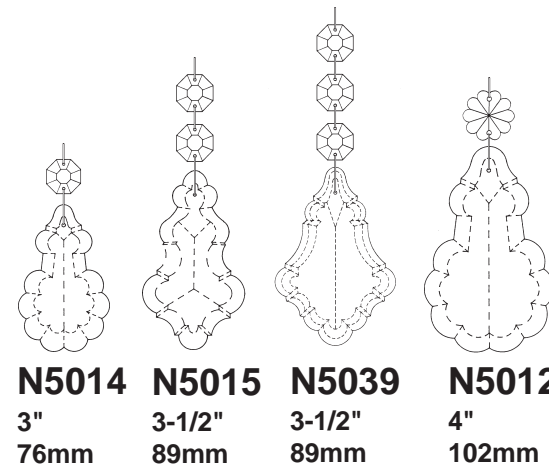

SET #2

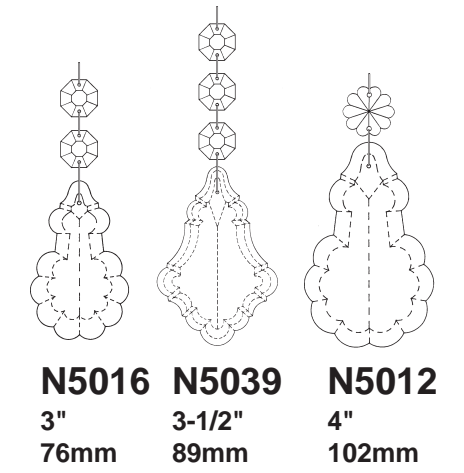

SET #3

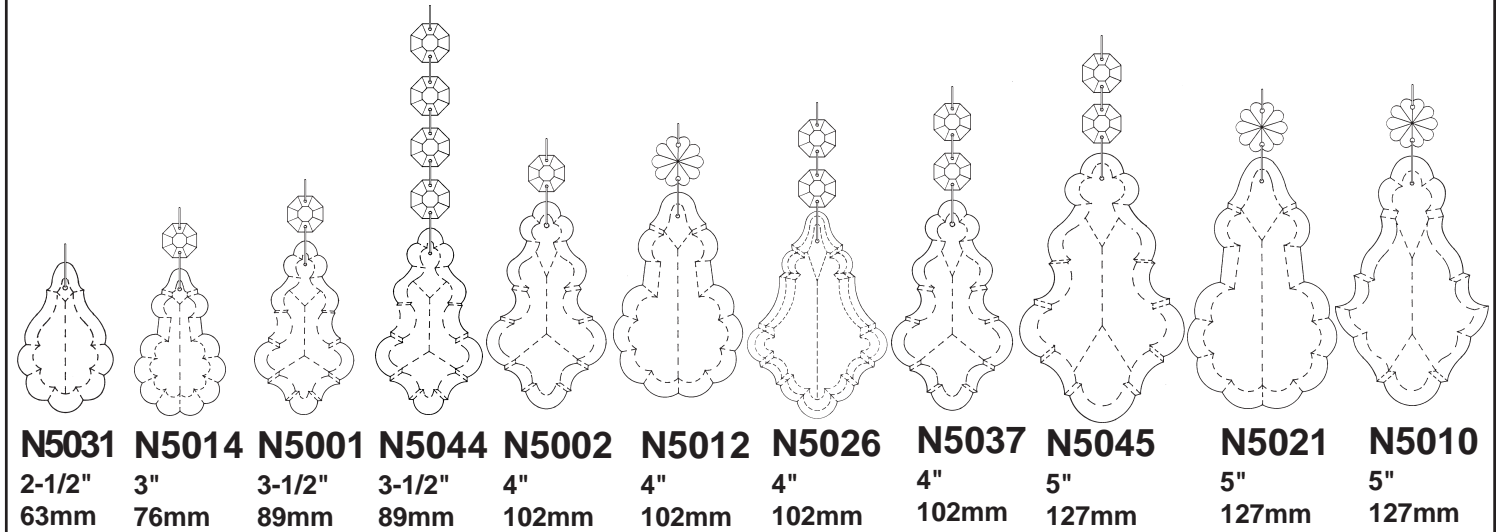

SET #4

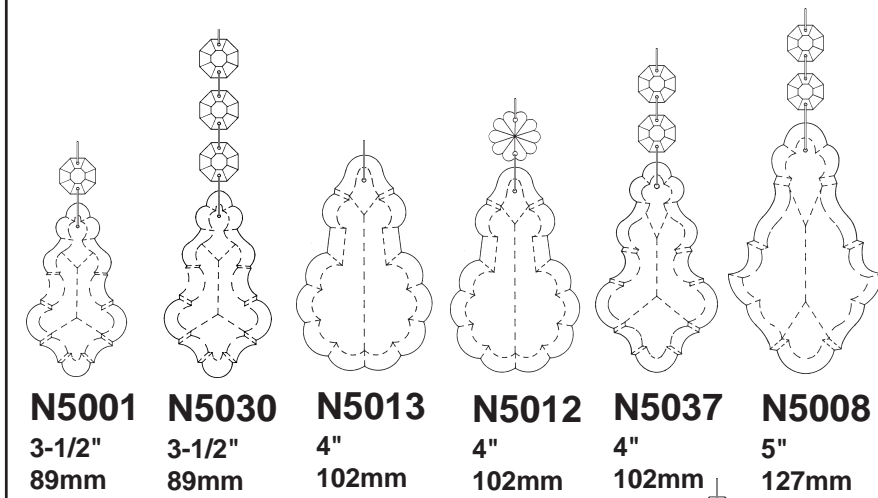

SET #5

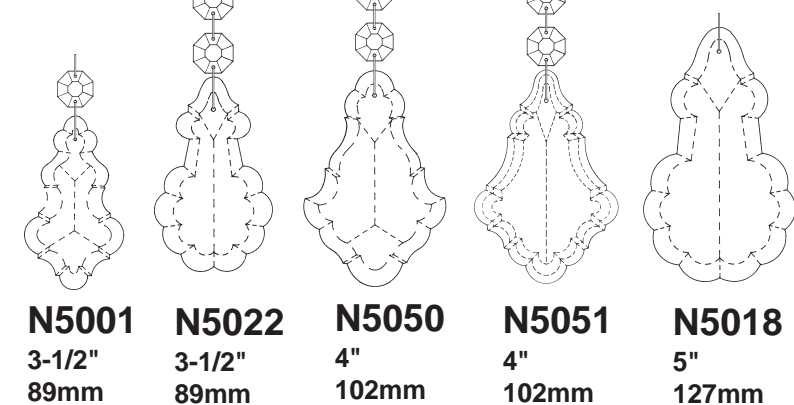

Crystal Set #5 in Black

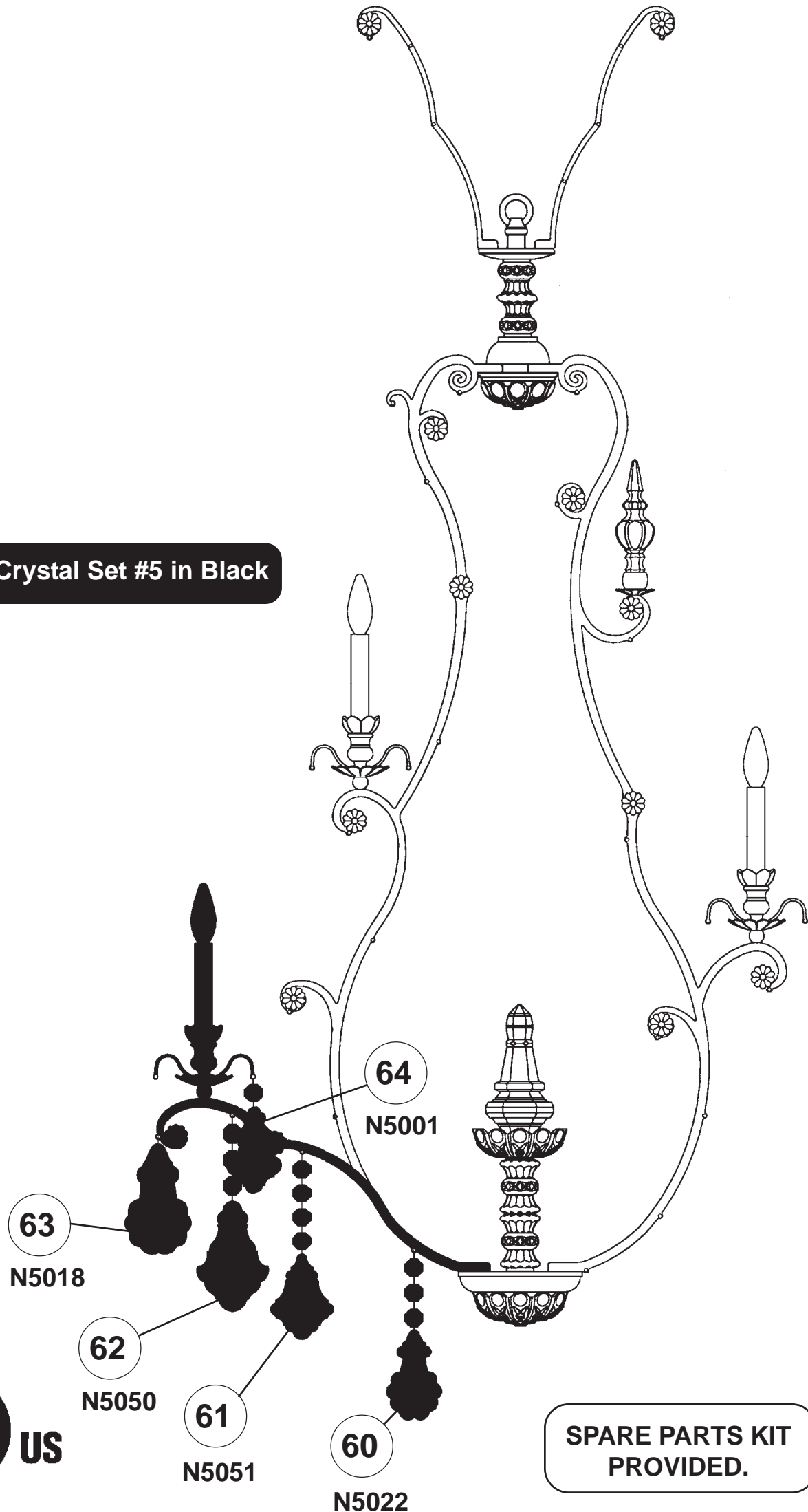

For easy removal of crystal from bubble pack, please cut along pouches on the inside of the seam. Gently remove crystal from the side of the pouch.

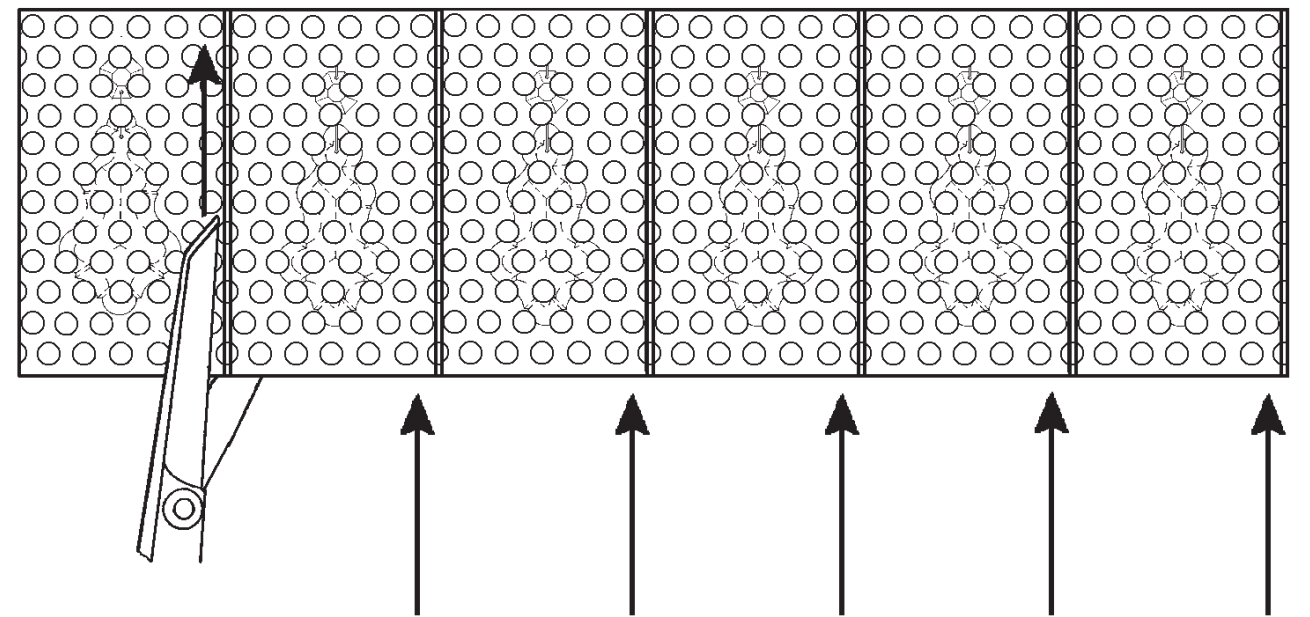

NOTE: Work on one crystal set at a time. Follow the black line from top to bottom according to the numbered steps on the trim diagram.

Instructions for crystal trimming
STEPS 22 - 64

Crystal Set #2 in Black

Crystal Set #1 in Black

Crystal Set #3 in Black

Crystal Set #4 in Black

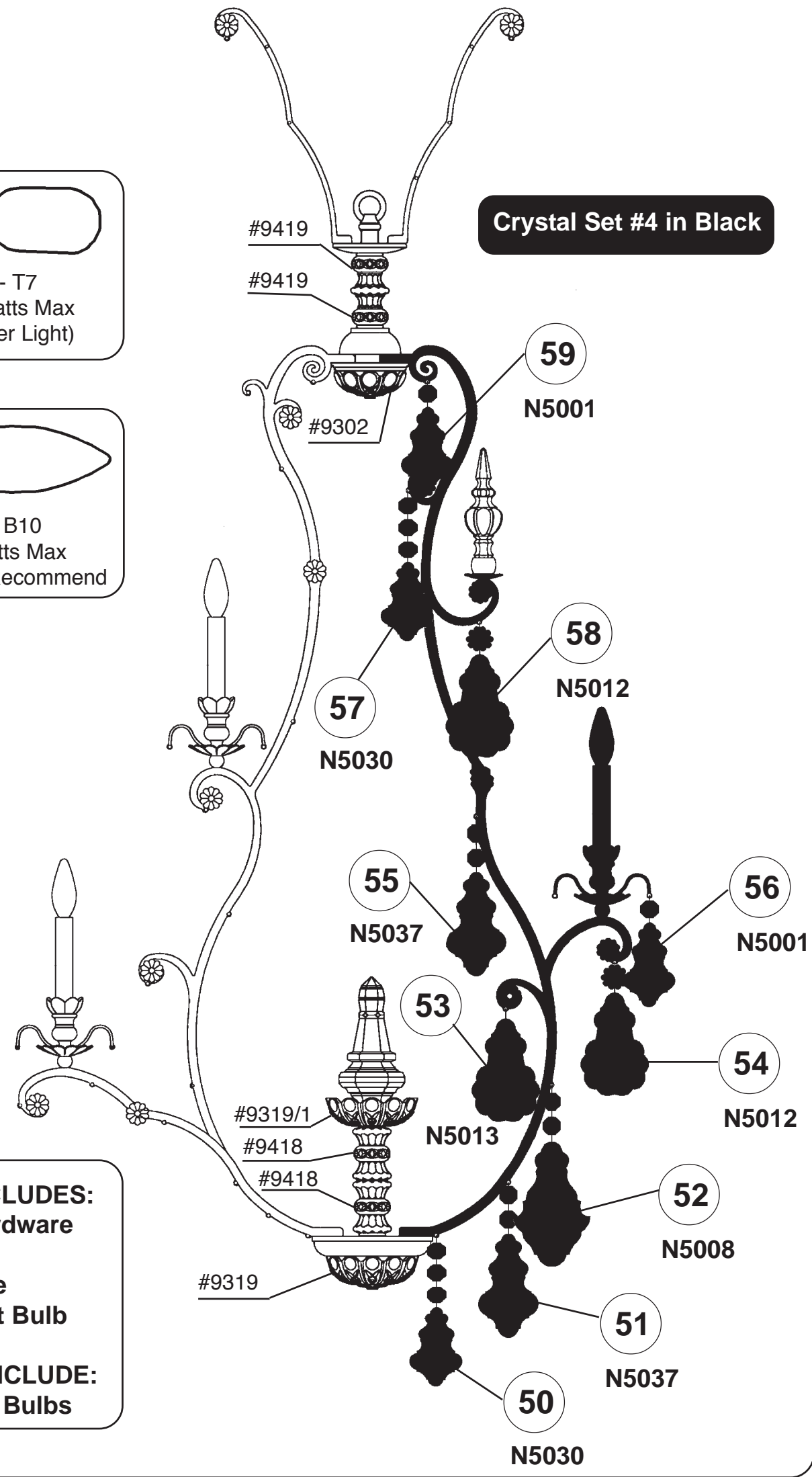
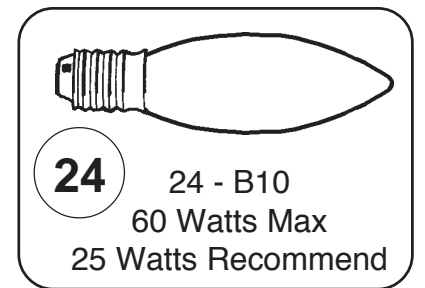
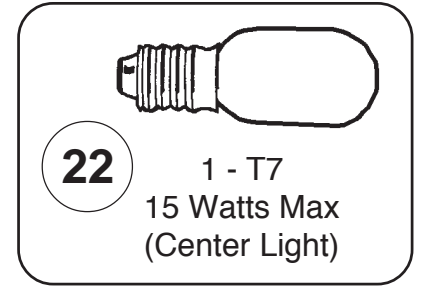
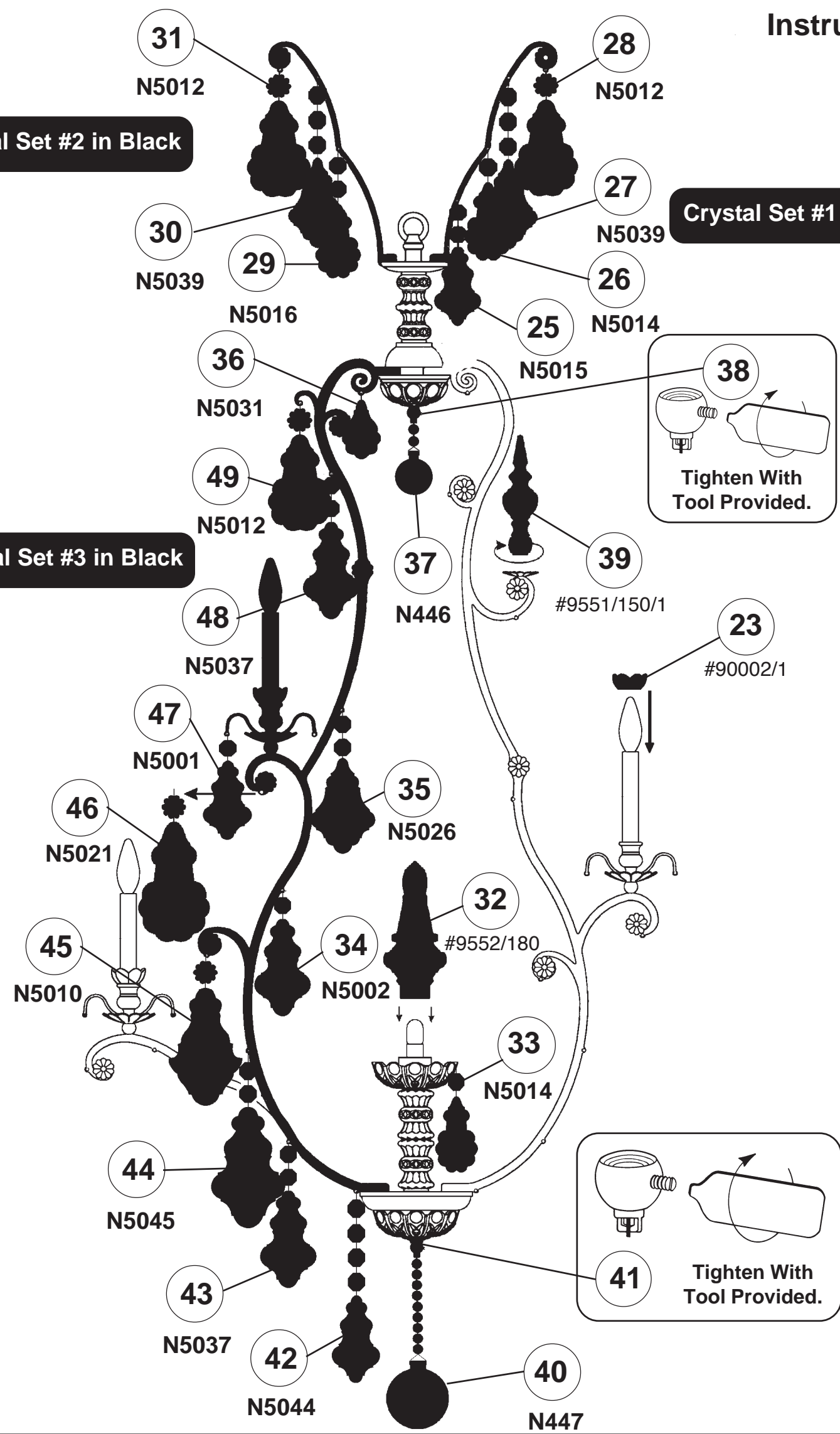

FIXTURE INCLUDES:
Hanger Hardware
Trim
Frame
1 - T7 Light Bulb

DOES NOT INCLUDE:
C10 - Light Bulbs