



B-Series Residential Deadbolt

Introducing the B-Series Residential Deadbolt that provides more security, more style and is designed to install in a snap.

Enhanced Security

- BHMA Grade 1 product performance
- Increased latch/bolt size offers maximum kick-in resistance
- Exclusive patented Schlage design
- Anti-pick shield

Faster, Easier Installation

- 3-piece assembly
- Installs in half the time
- SNAP & STAY™ feature for hands-free installation

Sleek, Low Profile Design

- Larger thumbturn is easier to grip
- Contoured edges for added style



Newly designed interior thumbturn is larger and easier to grip.



The Schlage Security Advantage

Three-piece design

Ready to go out of the box for quick installation.

Sleek Low profile face is almost impossible to grab with a wrench and cannot be unscrewed.

Versatile Shield is easily removed to fit 1 1/2" cross-bore prep.

Stronger 1/2" of bolt left in housing when bolt is thrown for added kick-in resistance.

Tougher Thicker metal strike reinforcer has 3" screws for greater strength in the jamb.

Secure Integrated anti-pick shield with SNAP & STAY™ self-adjusting tension provides added security and simplifies installation.

Required 1" door prep required for larger bolt housing.

Solid Zinc bolt has hardened steel pin inside that spins in response to sawing attack and can't be cut through.

Bigger Bolt diameter is 10% larger than typical bolts for maximum kick-in resistance.

Rounded Radius corners on strike plate for more attractive installation. 1 1/8" x 2 3/4" round corner strikes come standard.

UL Listed Optional 3-hour UL Listed fire cup/latch available.

Streamlined Deep drawn housing delivers a seamless piece of steel from beginning of helix to back of bolt for maximum latch/bolt reliability. Fits both 2 3/8" and 2 3/4" backsets.

Unprecedented Adjustable backset has the industry's only helical design that locks into place with no adjusting during installation. Fits both 2 3/8" and 2 3/4" backsets.

Code Compliant ADA compliant thumbturn.

Available Functions:

- B60 - Single cylinder deadbolt lock
- B62 - Double cylinder deadbolt lock
- B80 - Door bolt
- B81 - Door bolt with trim

Designed to fit virtually any door.

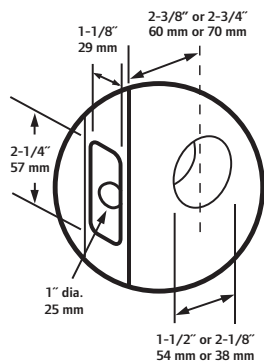

Standard door prep for B-Series installation.

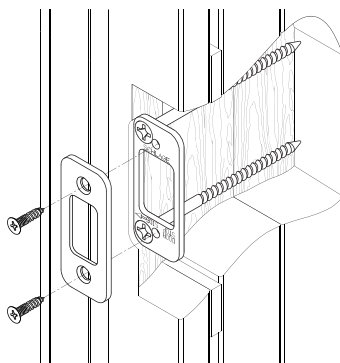

Strike reinforcement plate with 3" screws provides maximum resistance to kick-in attacks.

Available Finishes:



505/605
Bright Brass

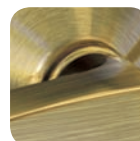

609
Antique Brass

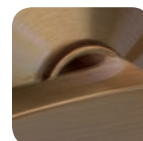

613
Oil Rubbed
Bronze

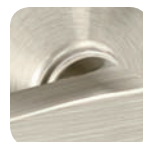

619
Satin Nickel



620
Antique Pewter



622
Matte Black

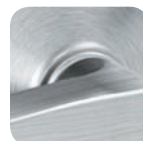

625
Bright Chrome

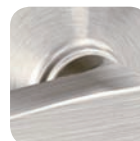

626
Satin Chrome



716
Aged Bronze

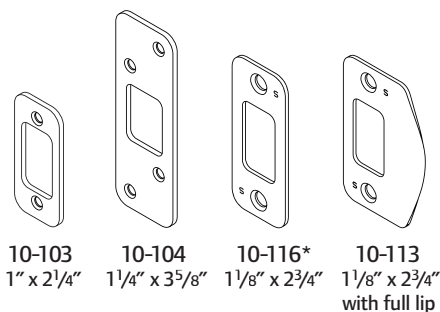

10-103 1" x 2 1/4"
10-104 1 1/4" x 3 5/8"
10-116* 1 1/8" x 2 3/4"
10-113 1 1/8" x 2 3/4" with full lip

NEW

A choice of four different strike plates makes the B-Series ideal for use on a wide variety of door preps.

* Comes in standard configuration.

To find out more visit us online at www.schlage.com.

