



Rinnai

UBBINK™ VENT SYSTEM FOR RINNAI TANKLESS WATER HEATERS

CONCENTRIC VENTING SYSTEM FOR INDOOR APPLICATIONS



UBBINK'S UNIQUE CONCENTRIC VENTING SYSTEM PROVIDES MAXIMUM PERFORMANCE, SAFETY, AND EASE OF INSTALLATION.

- Zero clearance to combustibles
- Single penetration through wall for both intake and exhaust
- Easy assembly
- Available with either plastic or metal outer vents (all units have an aluminum inner exhaust vent)
- Compatible with all indoor Rinnai water heater models, except the 98 series which utilizes separate intake and exhaust venting



ubbink

VERTICAL AND HORIZONTAL VENTING EXAMPLES

VERTICAL VENTING

ALL PRODUCTS AVAILABLE WITH METAL OR PLASTIC OUTER VENTS

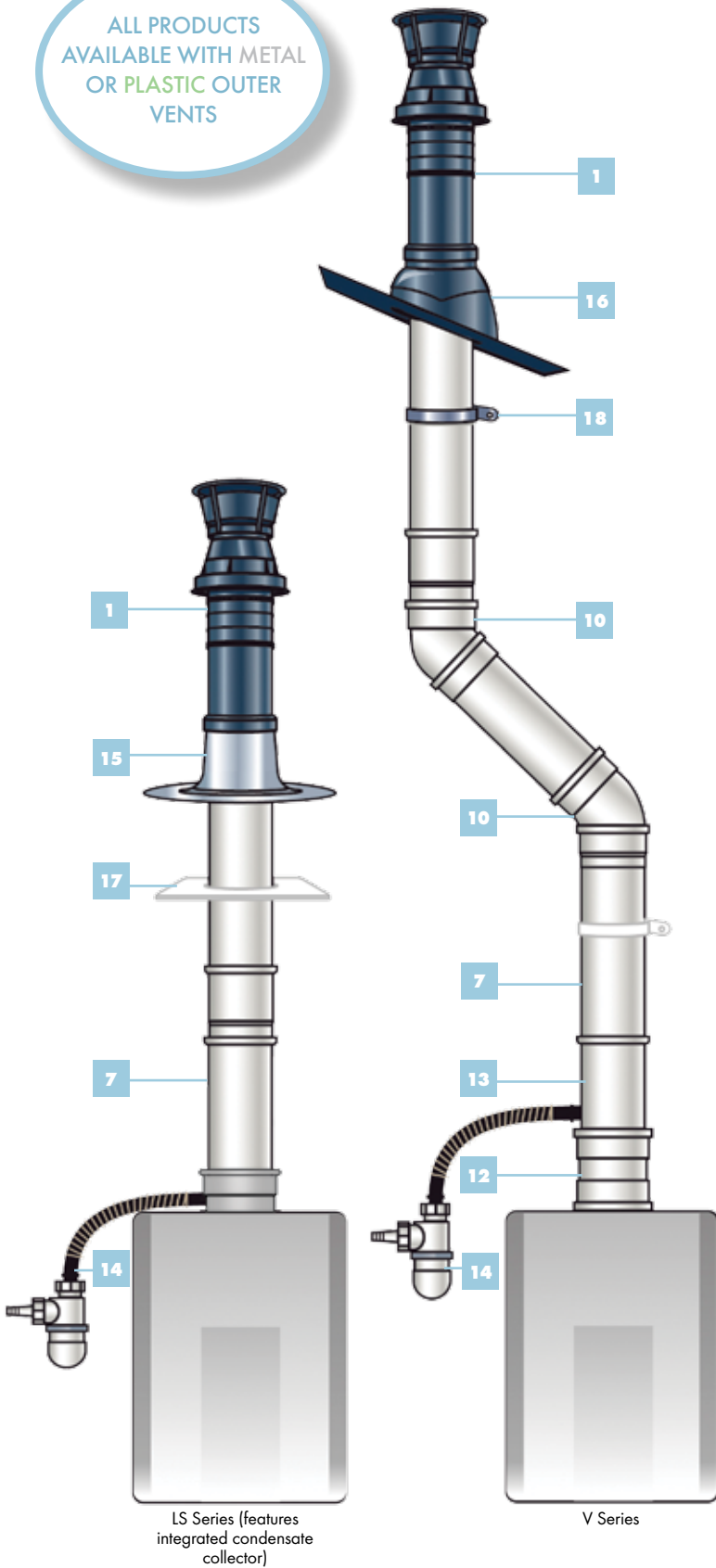

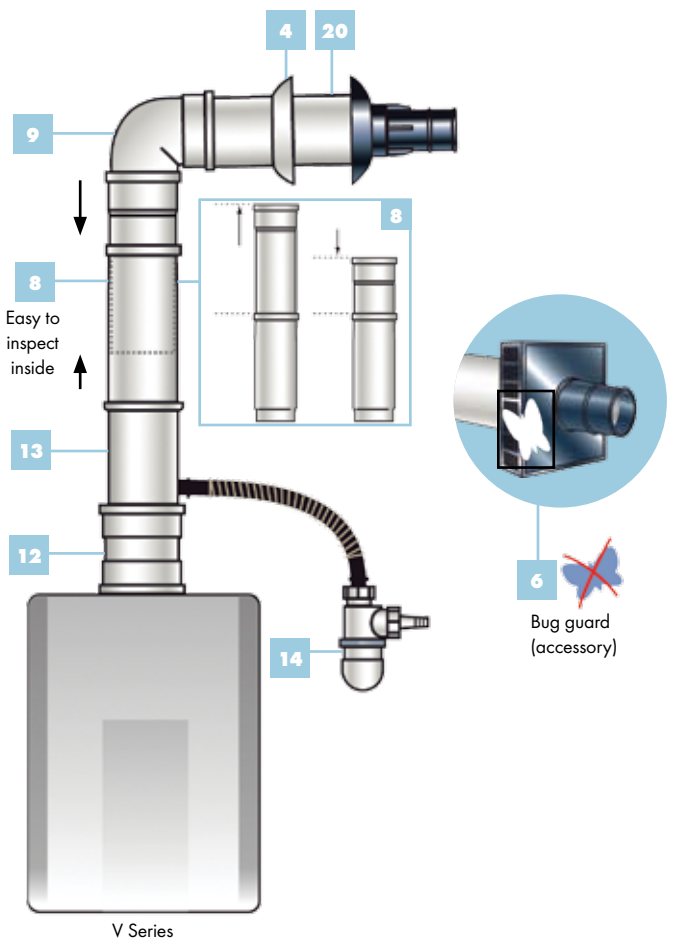
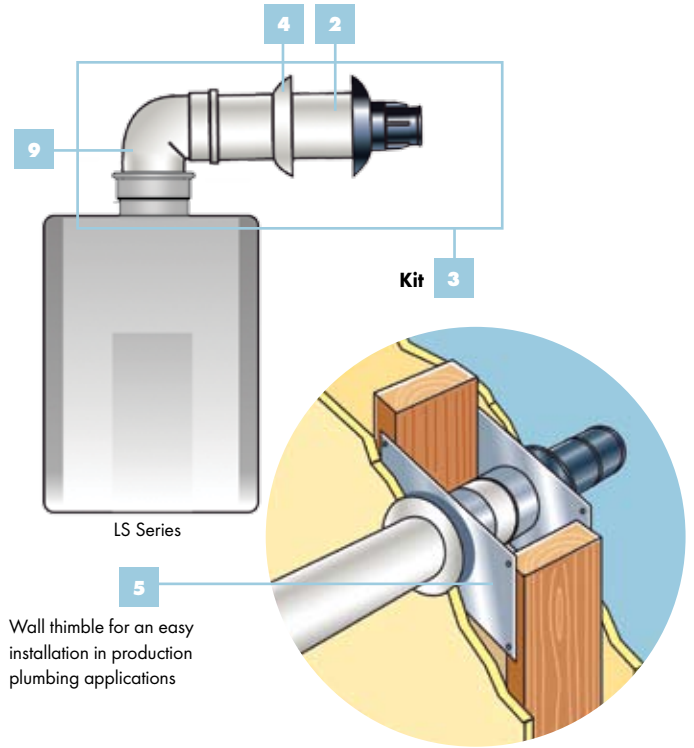

HORIZONTAL VENTING



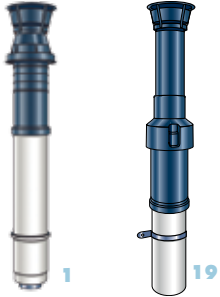

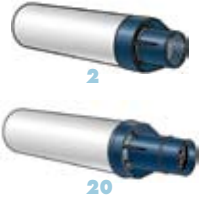
ROLUX® CONCENTRIC VENT SYSTEM

		Plastic outer	Metal outer	
VERTICAL TERMINATIONS				
	1	184118-S	184127	Roof Discharge Termination 18" (above roof)
	19	184119		Roof Discharge Termination 38" (above roof), cold climate

		HORIZONTAL TERMINATIONS		
	2	223161	223155	12" Standard Horizontal Termination
		223152	223156	21" Standard Horizontal Termination
	20	223157	223159	12" All-Weather Horizontal Termination
		223171		21" All-Weather Horizontal Termination

		HORIZONTAL TERMINATION KITS		
	3	STDKITVA-S	223167	12" Standard Termination Kit (LS Series) * (R94LSi, R75LSi, R50LSi)
		STDKITVA-S21		21" Standard Termination Kit (LS Series) (R94LSi, R75LSi, R50LSi)
	22	STDKITVA-A	223168	12" All-Weather Termination Kit (LS Series) * (94LSi, R75LSi, R50LSi)
		STDKITVA-A21		21" All-Weather Termination Kit (LS Series) (94LSi, R75LSi, R50LSi)
	24	224046		Raised Horizontal Termination Kit ("Snorkel") (94LSi, R75LSi, R50LSi)

* Vent Kits for the V Series water heaters are available as well. The 12" standard termination kit is STDKITV-S and the 12" all-weather kit is STDKITV-A

		VENT PIPE EXTENSIONS		
	7	224051	224260	10" Vent Pipe Extension
		224052	224265	19.5" Vent Pipe Extension
		224053	224270	39" Vent Pipe Extension
	8	224054	224275	Telescoping Vent Length
	9	224063	224255	90 Degree Elbow
	10	224050	224250	45 Degree Elbow (Qty of 2)

		HORIZONTAL AND VERTICAL ADAPTERS FOR V SERIES		
	11	50710327	224257	Horizontal Discharge Adaptor
	12	224064	224240	Vertical Discharge Adaptor (4" length)
	13	224069	224245	Condensate Collector (6" length)

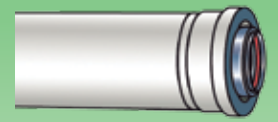

PLASTIC OUTER FOR INTAKE

- Easy to cut compared to stainless steel
- Dent and impact resistant
- Corrosion-proof
- Non-flammable material (UL94-V0)
- Seamless extruded materials
- Casted elbows and adapters
- White semi-gloss finish (EU RAL 9016)

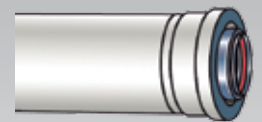

METAL OUTER FOR INTAKE

- Painted galvanized steel
- Easy to cut compared to stainless steel
- Metal outer available when required by local codes
- Dent and impact resistant (bends and adapters)
- White semi-gloss finish (EU RAL 9016)
- Wall thickness 15% greater than stainless steel
- Casted elbows and adapters

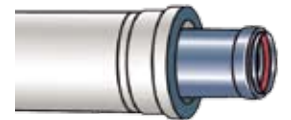







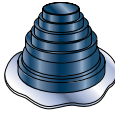

ALUMINUM INNER FOR EXHAUST

- Easy to cut compared to stainless steel
- Stable, thick-walled material
- Dent and crease resistant
- Not affected by scratches
- Seamless extruded material
- No weld lines
- Thick-walled, casted elbows and adapters
- Lightweight
- Seal rings with maximum temperature 400°F (approx. 200°C)

ROLUX® CONCENTRIC VENT SYSTEM

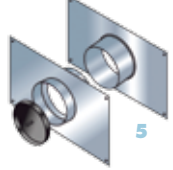
Suitable for plastic and metal components

ROOF TILES AND FLASHINGS			
	15	146141	Roof Flashing Assembly-Flat
	16	189950	Polymer Rubber Roof Flashing Assembly-1/12 to 12/12 pitch
		189951	Polymer Rubber Roof Flashing Assembly-6/12 to 12/12 pitch
		189952	Polymer Rubber Roof Flashing Assembly-8/12 to 16/12 pitch
	25	242141	Flashing for Metal Roof

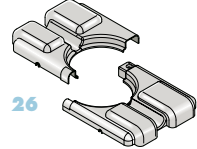
ACCESSORIES			
	4	710342	Rubber Wall Plate (white)
		710602	Rubber Wall Plate (black)
	5	224045	Thimble (1 piece per box)
	6	224043	Bug Guard
	14	222050	Condensate Trap
	17	224097	Metal Pass Through Plate
	18	169044	Pipe Clamp
	26	224040	Water Heater Guard (for commercial applications)

Rinnai is continually updating and improving products; therefore, specifications are subject to change without prior notice. Local, state, provincial and federal codes must be adhered to prior to and upon installation.

FOR MORE INFORMATION ON RINNAI PRODUCTS

ADDITIONAL RINNAI LITERATURE AVAILABLE

Rinnai Corporation

103 International Drive
Peachtree City, GA 30269

Toll Free 1-866-RINNAI-1

Phone: 678-829-1700 • Fax: 678-364-8643

Visit our Websites: www.rinnai.us • www.foreverhotwater.com

E-mail: marketing@rinnai.us



Rinnai



ublink



Ubbink bv

P.O. Box 26
6980 AA Doesburg
The Netherlands

T +31 313 48 02 00

F +31 313 47 39 42

rolux@ublink.nl

www.ublink.nl