

Please go to www.quoizel.com for product cleaning tips. Go to the **Care + Maintenance** selection.

Tools Required: Flathead screwdriver, Phillips screwdriver, pliers, wire cutters, wire strippers, electrical tape, safety glasses.

Light Source: (2) A19 Medium Base 100W bulb Maximum, bulb not included.

Estimated Assembly Time: 30-45 minutes

Preparation: Identify and inspect all parts before beginning installation. Check package content list and diagrams below to ensure all parts are present. If any parts are missing or damaged, do not attempt to assemble, install, or operate the fixture. Missing Parts? Contact your original place of purchase.

⚠ Warnings and Cautions

Turn off electricity at circuit breaker or main fuse box before installation. Consult a licensed electrician if in doubt.

These instructions are provided for your safety. It is very important you read them completely before installing the fixture. We strongly recommend that a licensed, professional electrician perform the installation.

Disconnect fixture from power source before replacing bulbs. Make sure bulbs are given sufficient time to cool before removal.

Package Contents

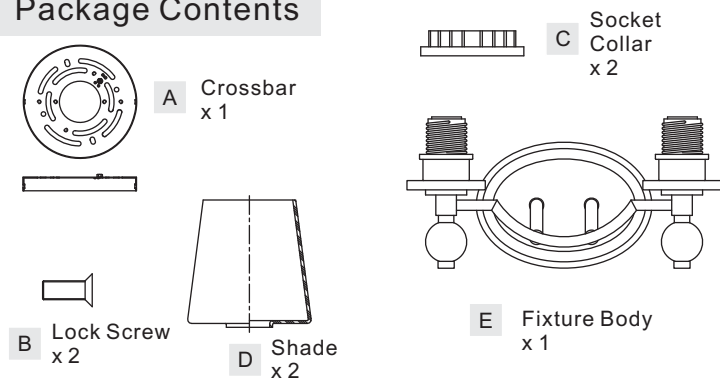

STEP 1 - Install the Crossbar to the junction box

A. Attach the Crossbar (A) to the Outlet Box with the head of the Green Ground Screw facing you. Secure it with Outlet Box Screws (not included), tighten until snug.

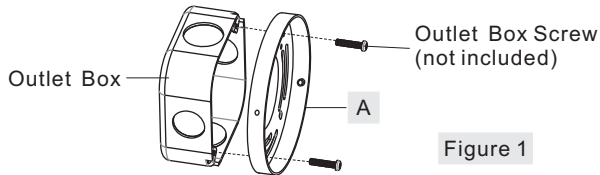

STEP 2 - Wire Connections

A. Wrap bare or green ground wire around green ground screw on the crossbar, no less than 2 inches from the end of the wire. Tighten the green ground screw.
B. Use standard wire connectors (not included) to make all wire connections. Twist connectors until wires are tightly joined together. Wrap each connection with approved electrical tape and carefully stuff all the connected wires into the Outlet Box.

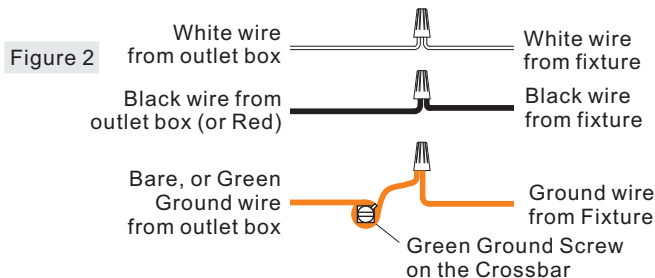

STEP 3 - Install Fixture Body

A. Place the Backplate and the Fixture Body (E) over the Crossbar (A). Line up Holes on the side of backplate and the Mounting Hole on the Crossbar (A). Secure by threading Lock Screws (B) into the Crossbar (A). Tighten until snug.

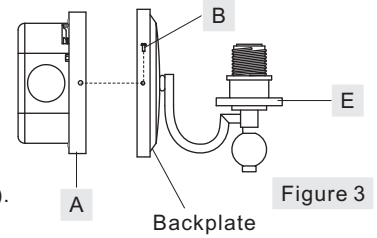

STEP 4 - Install Shades and Bulbs

A. Position the Shade (D) over the Socket as shown. Secure the Shade (D) by threading the Socket Collar (C) onto the Socket. Hand tighten until snug.
B. Insert bulbs onto sockets and screw snugly into place.

Your fixture is now assembled and ready to use. Enjoy!

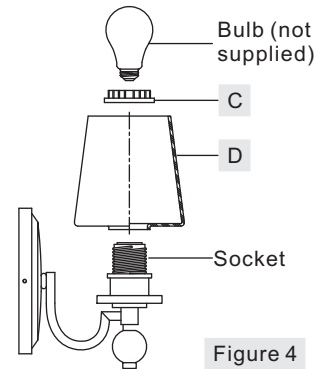

HS8602BN
FINISH: BRUSHED NICKEL

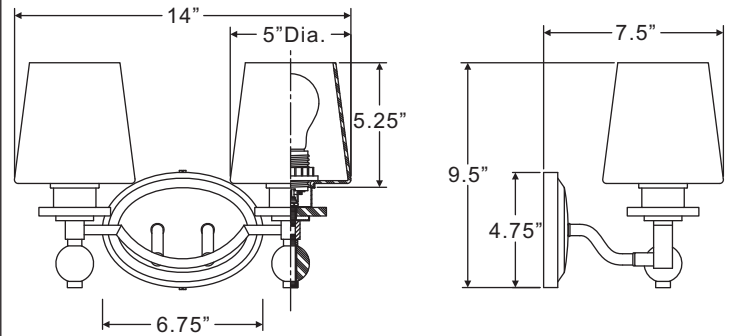

NOTE: ALL DIMENSIONS ARE ROUNDED UP TO THE NEAREST 1/4"