

SAFETY INFORMATION

Please read and understand this entire manual before attempting to assemble, install or operate the product.

WARNING

- RISK OF ELECTRIC SHOCK - Before beginning installation, turn off electricity at the circuit breaker box or the main fuse box.
- RISK OF FIRE - Use bulbs specified by the markings and/or labels on the fixture.

CAUTION

- For your safety, read instructions completely before beginning installation.
- If in doubt about electrical installation, consult a licensed electrician.
- Turn off electricity to fixture before replacing the bulb(s).

TOOLS REQUIRED

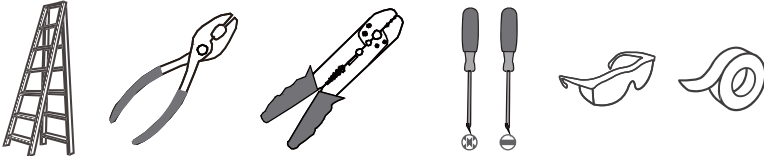

CARE OF TIFFANY STYLE SHADE

A new Tiffany lamp shade has an oil film applied to the shade that protects the Tiffany shade from scratches during shipment. If the oil applied is too heavy you can remove the excess oil film with a paper towel. Gently wipe away the excess oil.

For general cleaning of Tiffany shades use a gentle lemon oil-based furniture polish applied to a soft cloth and wipe gently.

If a white powder appears on the soldered joints of the Tiffany shade this is a normal oxidation process. Use a small amount of lemon oil or mineral oil applied directly to oxidized areas and the soldered area will return to like new.

CARE AND MAINTENANCE

- Wipe clean using soft, dry cloth or static duster. Always avoid using harsh chemicals and abrasives to clean fixture as they may damage the finish.

If you need further assistance call Quozel Customer Care at 1-800-645-3184 (9:00am - 5:00pm EST), or visit us on-line at www.quezel.com.

PACKAGE CONTENTS

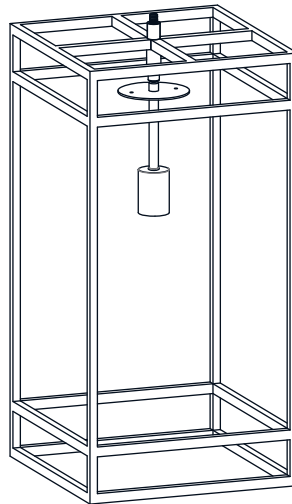
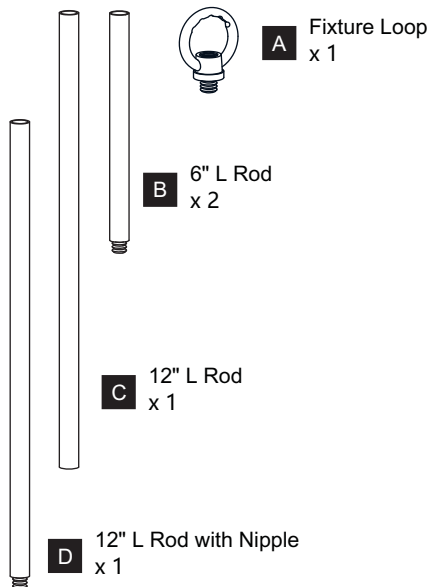

E Fixture Body x 1

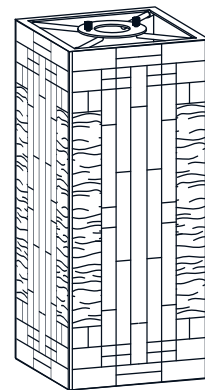

F Shade x 1

MOUNTING HARDWARE

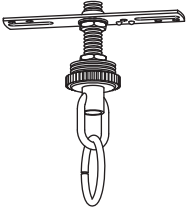

AA Crossbar Assembly
x 1

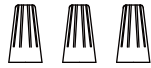

BB Wire Connector
x 3



CC Outlet Box Screw
x 2

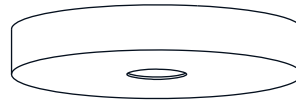

DD Ceiling Canopy
x 1

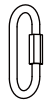

EE Quick Link
x 1

INSTALLATION

1 Install Shade

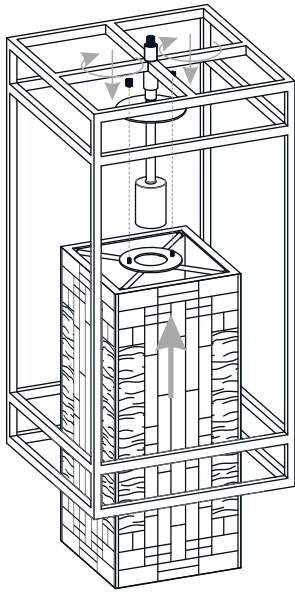

2 Install Rods

Optional Rods:

- 8 Feet Ceiling:
(1) 12"L Rod.
- 9 Feet Ceiling:
(2) 12"L Rods.
- 10 Feet Ceiling:
(2) 6"L Rods + (2) 12"L Rods.

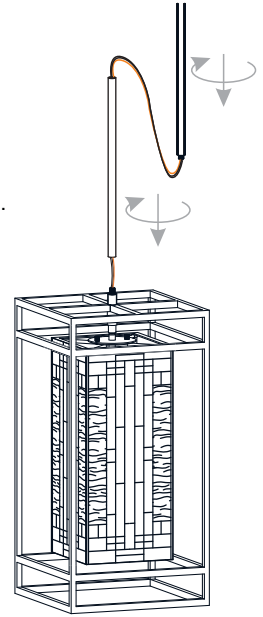

3 Install Fixture Loop

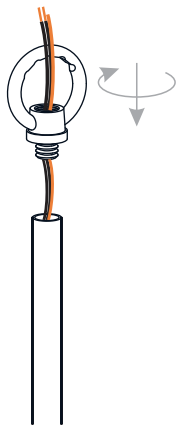

4 Install Crossbar Assembly

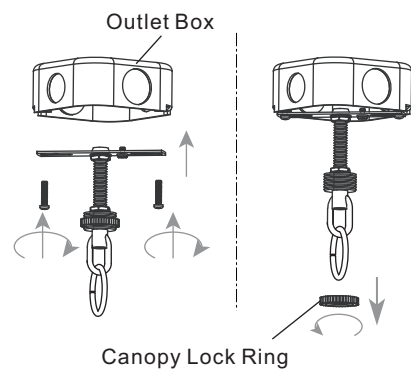

INSTALLATION

5 Install Quick Link and Pull Supply Wires

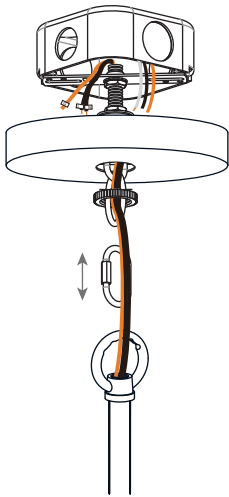

* Ceiling Canopy shape is varies depends on item purchased.

6 Wiring

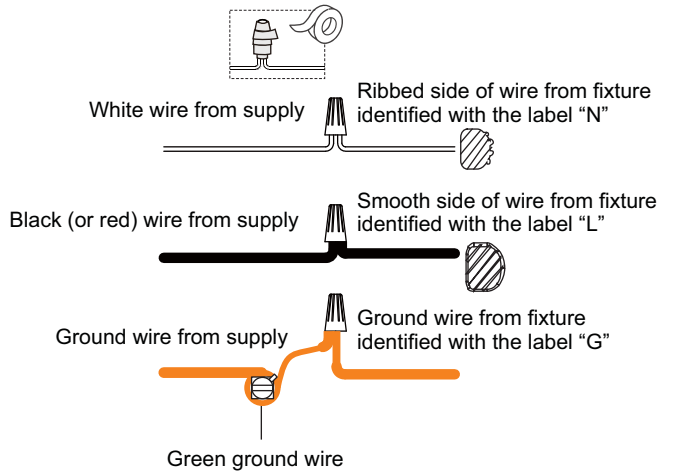

7 Install Ceiling Canopy

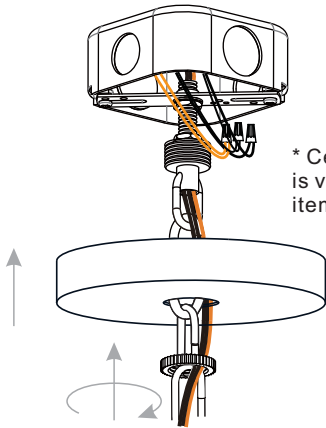

* Ceiling Canopy shape is varies depends on item purchased.

8 Install Bulb

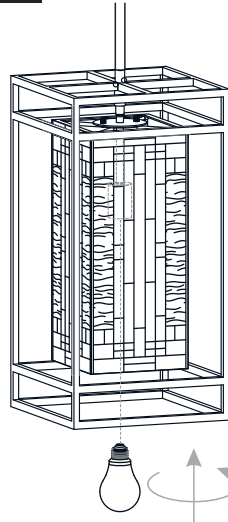

Install the correct bulb referring to fixture markings and/or labels for maximum wattage.

Recommended Bulb Type (not included):

BULB BASE TYPE
Medium (E26)

BULB TYPE
TYPE A

Your installation is now complete! Restore electricity and save this sheet for future reference.