

# Installation Guide

## For Styles SQR8604GV and SQR8604RK

### Tools Required

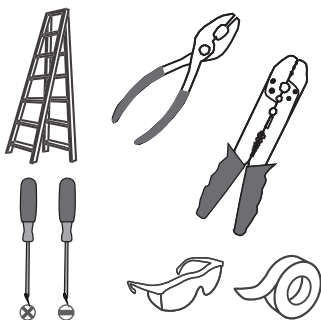

### Light Source

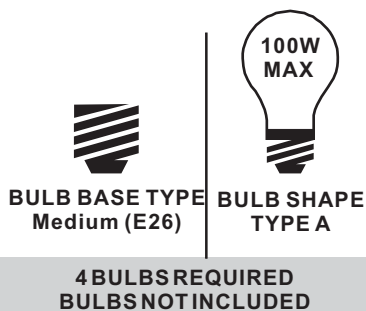

### Warnings and Cautions

Turn off the electricity at the circuit breaker before installation. Consult a licensed electrician if in doubt about installation.



Turn off power to the fixture and allow the bulbs to cool before replacing.

### Package Contents

**Preparation:** Identify and inspect all parts before beginning the installation.



Missing or damaged parts? Contact your original place of purchase.

#### PARTS BAG

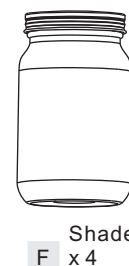
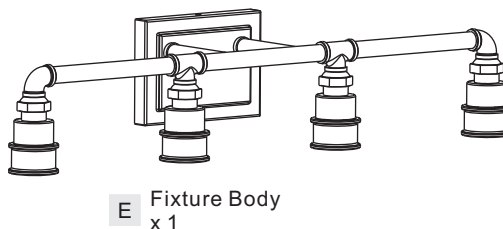
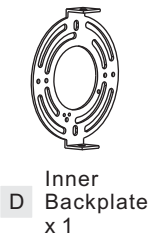
-  **A** Mounting Screw x2
-  **B** Outlet Box Screw x2
-  **C** Wire Connector x3

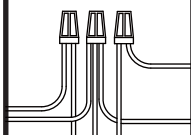
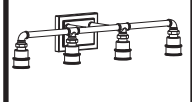

### Table of Contents

Inner Backplate	Wiring	Fixture Body	Shade & Bulb
			
<b>STEP 1</b>	<b>STEP 2</b>	<b>STEP 3</b>	<b>STEP 4</b>

## STEP 1

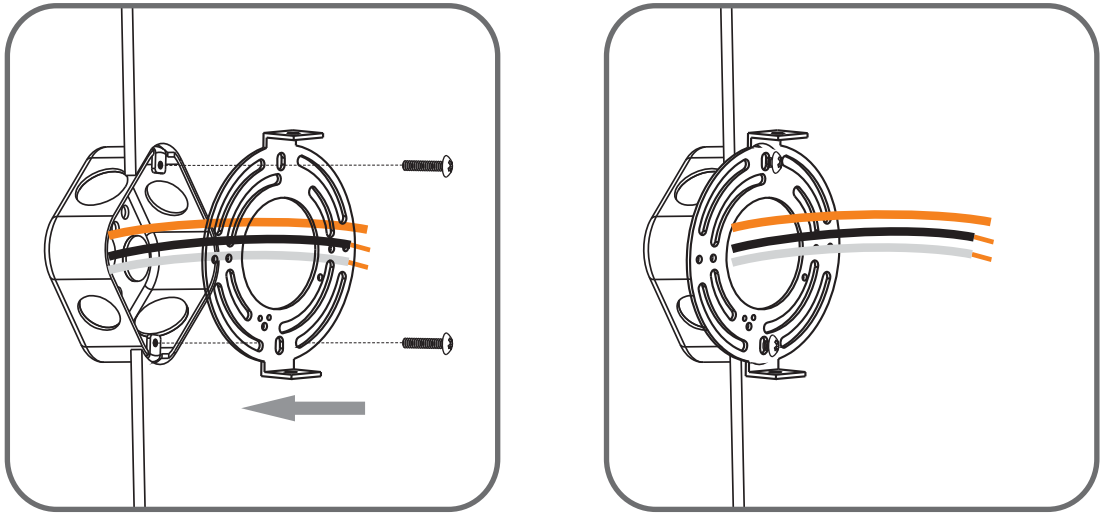

## STEP 2

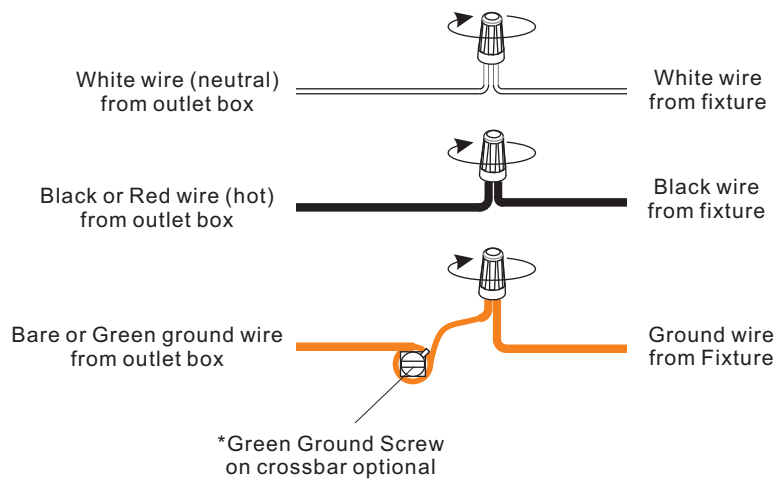

## STEP 3

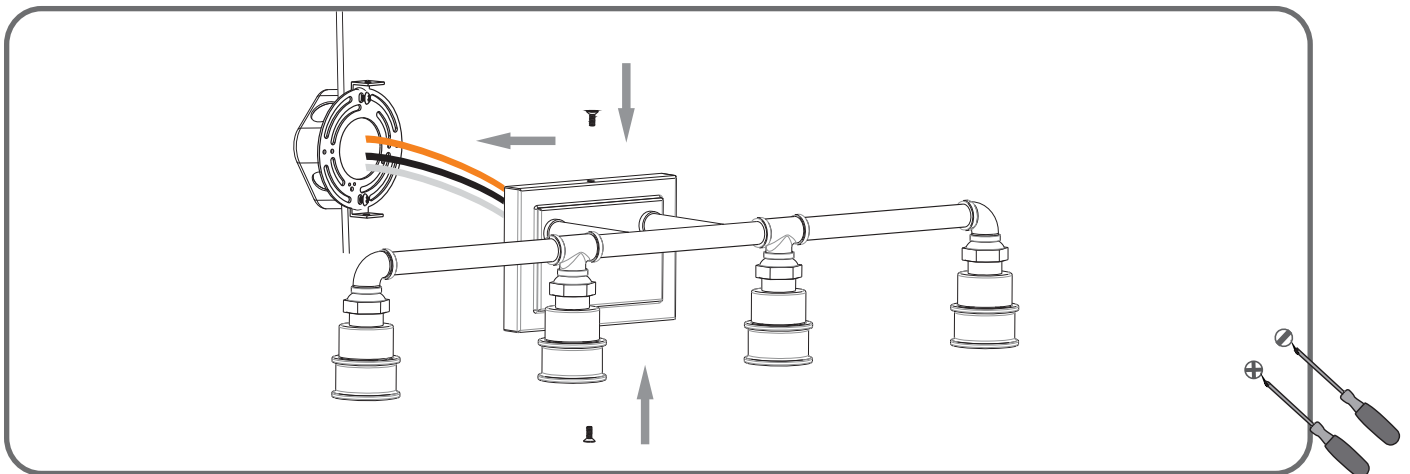

**STEP 4**

**OPTION 1**

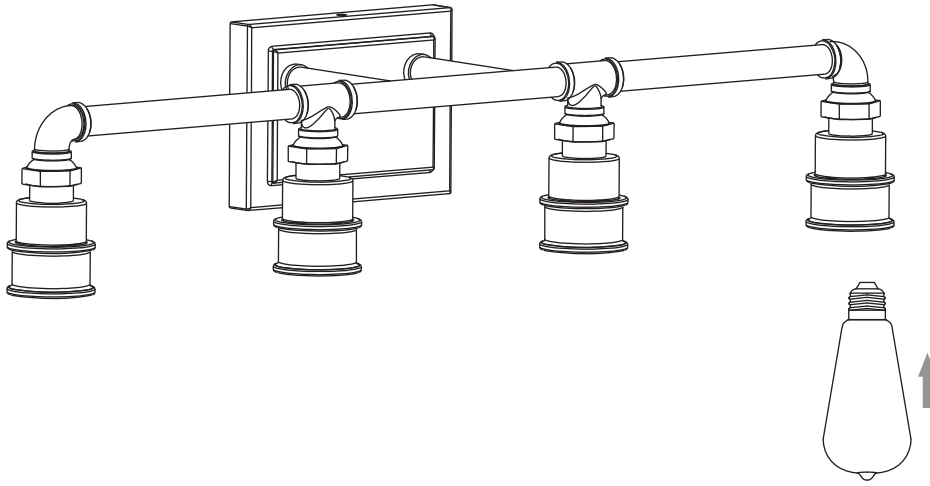

**OPTION 2**

